

1. 井戸SE6166全景  
西から

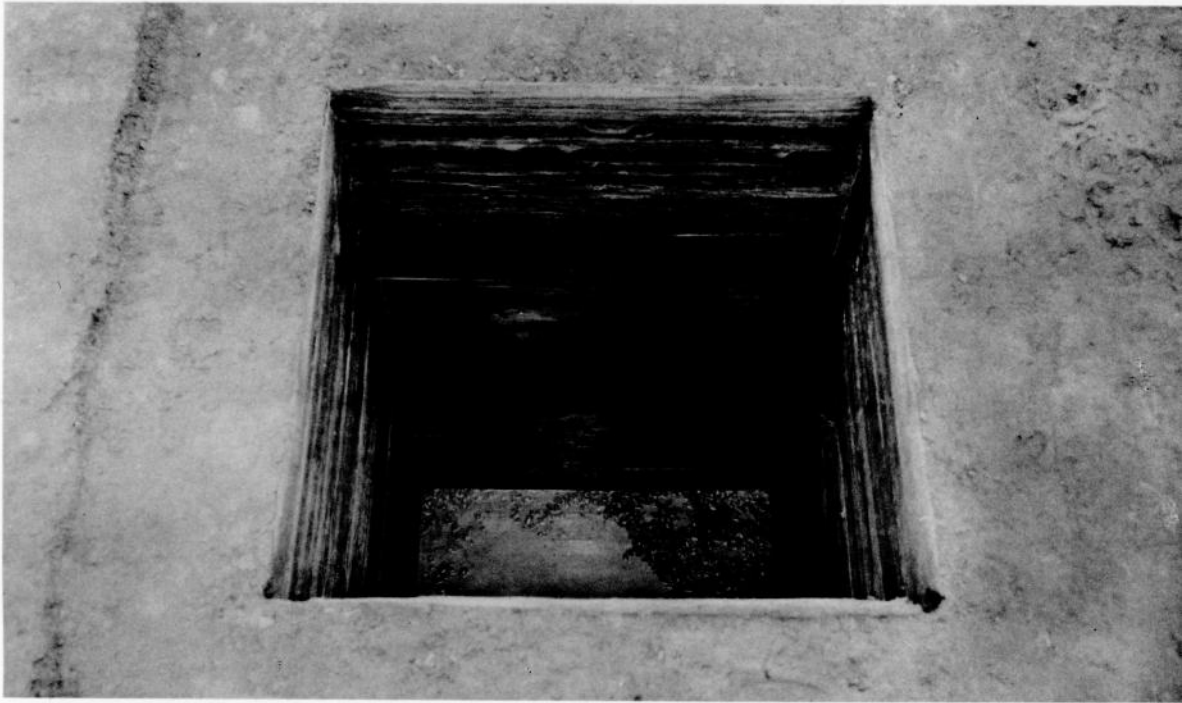

2. 同上 南から



3. 同上  
東南隅井戸枠組方の状況

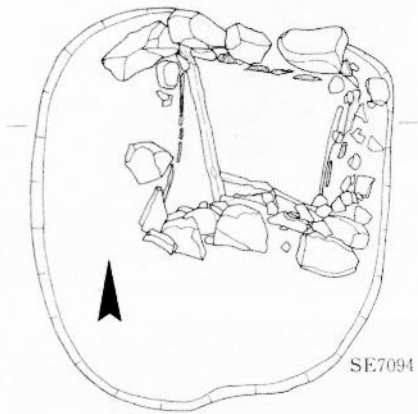

H69.40m

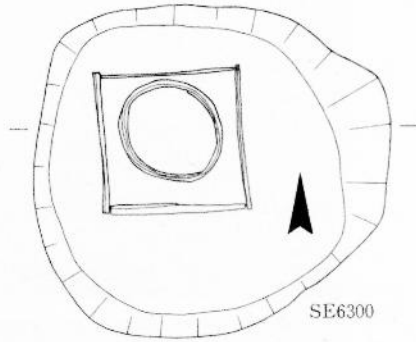
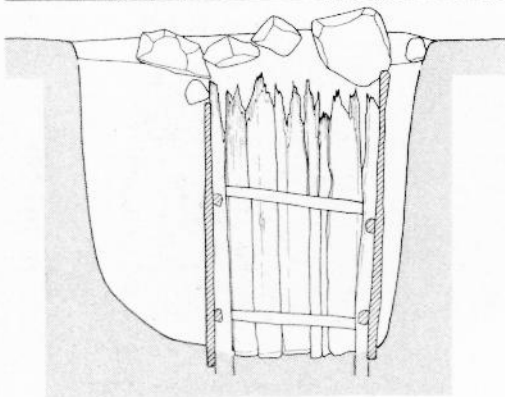

H69.80m

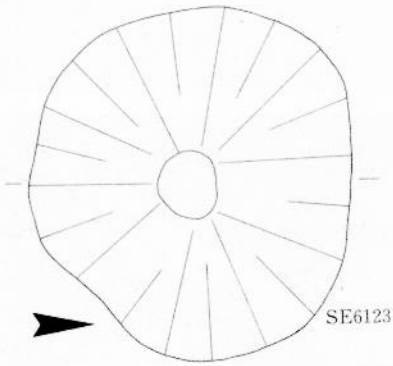
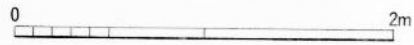
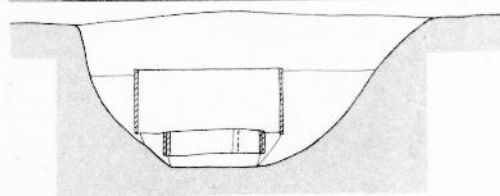

H69.80m

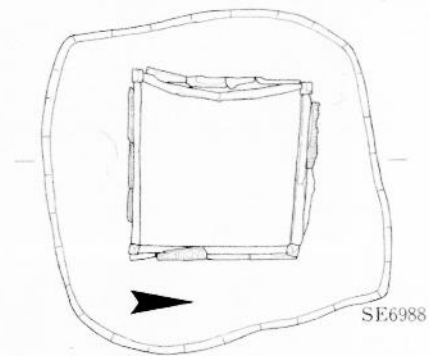
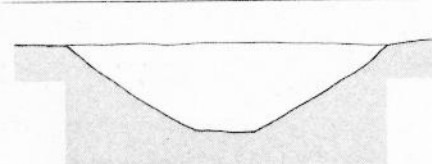

H69.40m

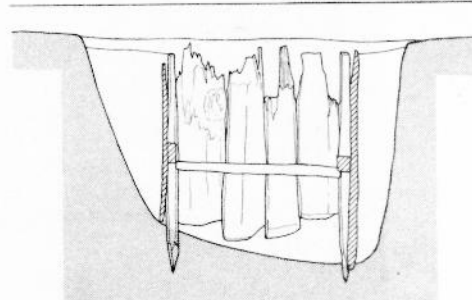

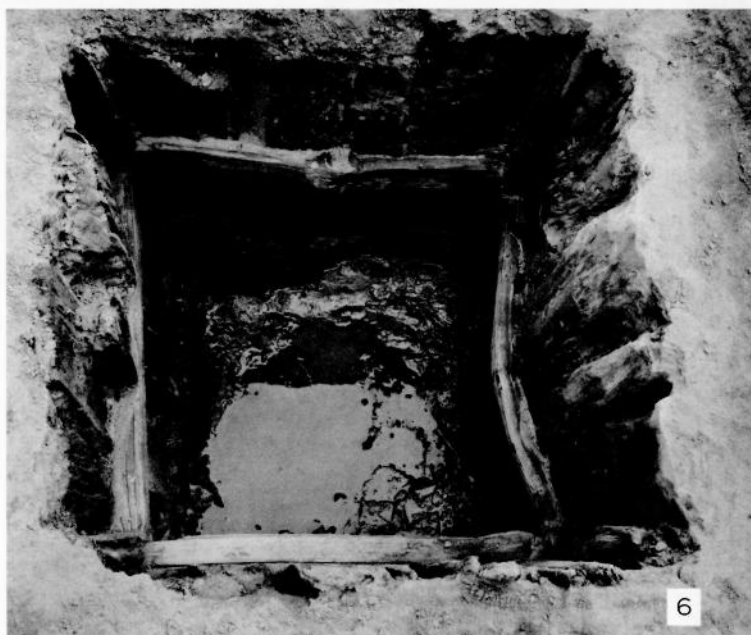
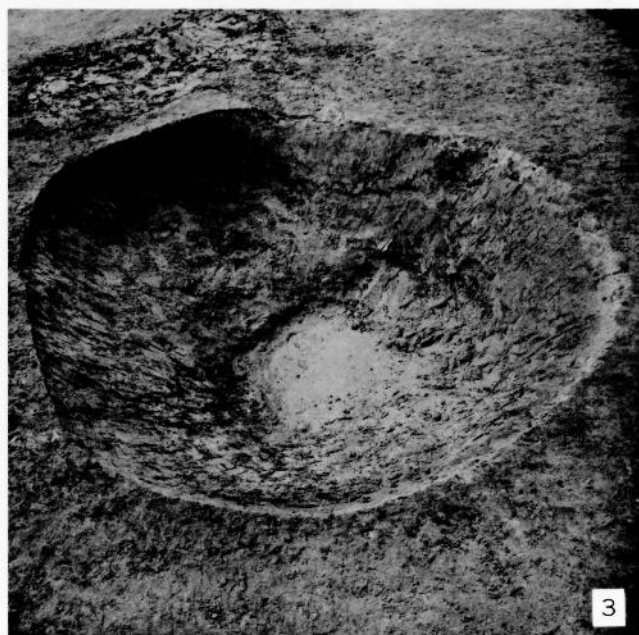
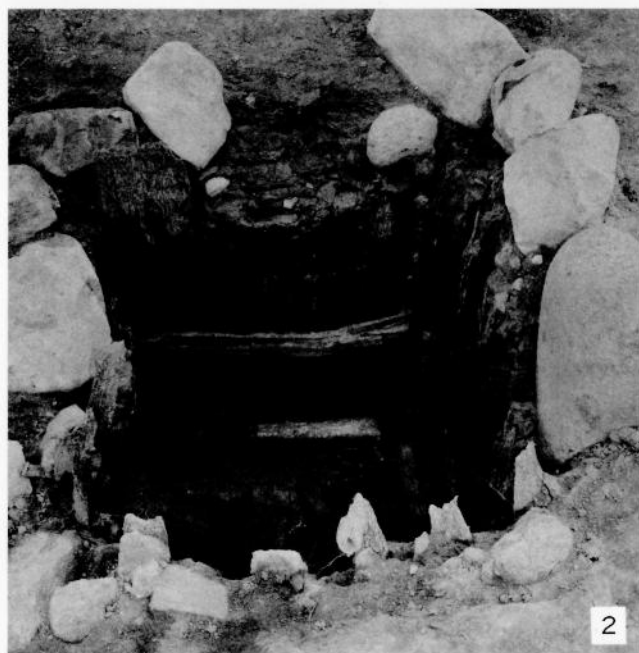

1. 井戸 SE7094 全景 南から

2. 同上細部 東から

3. 井戸 SE6123 東から

4. 井戸 SE6300 北から

5. 井戸 SE6988 全景 東から

6. 同上細部 北から

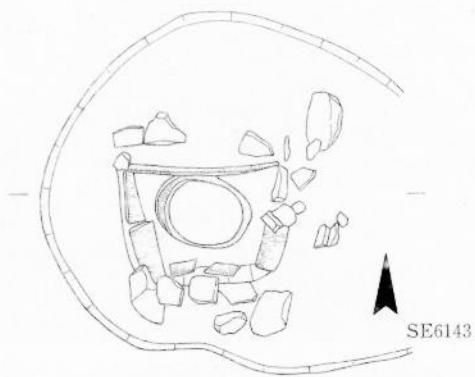

H69.40m

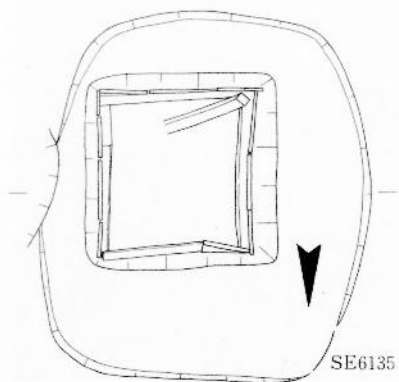

H69.80m

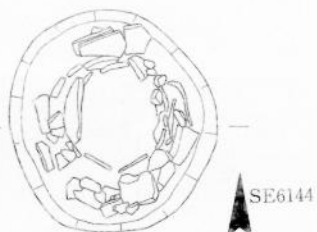
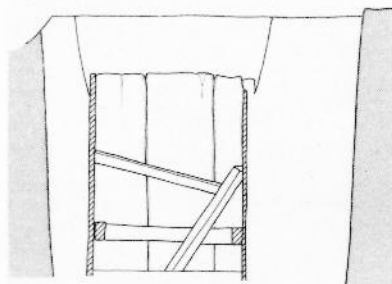
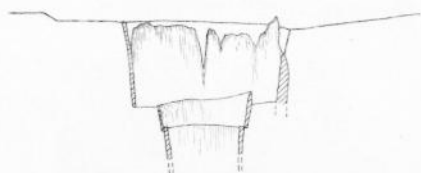

H69.40m

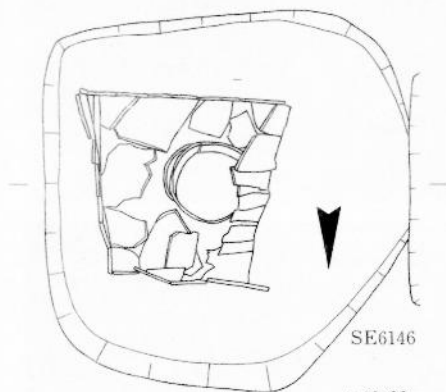

H69.80m

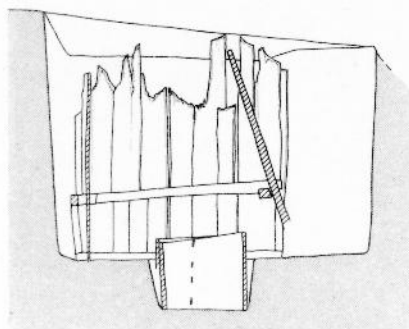
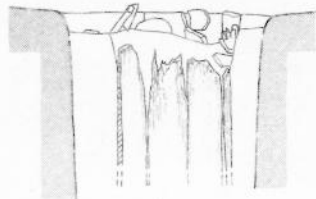

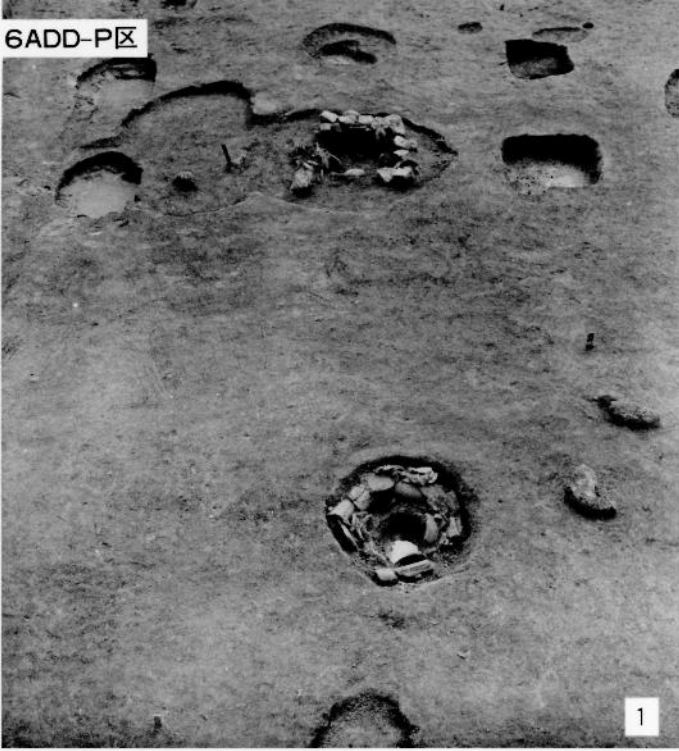

1

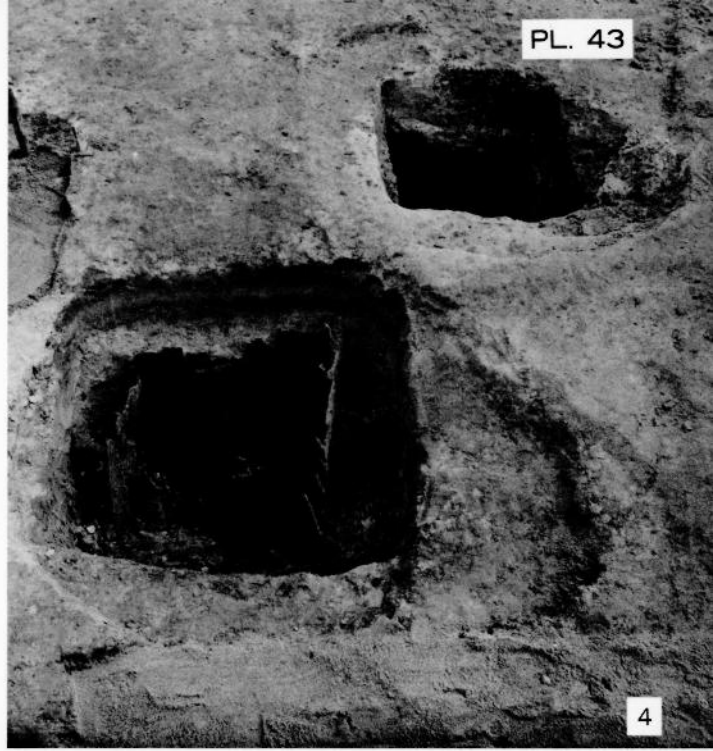

4



2



5



3



6

1. 井戸SE6143(上)・SE6144(下) 北から  
 2. SE6143細部 東から  
 3. SE6144細部

4. 井戸SE6135(右)・SE6146(左) 西から  
 5. SE6135細部 東から  
 6. SE6146細部 北から

## 弥生時代の遺構

1. 住居SB6122・土壇  
SK6121と奈良時代  
建物SB6120の重複  
状況 南から
2. SB6122 東北から
3. 土壇SK7124 西から
4. 土壇SK7123 北から
5. 土壇SK7101 北から

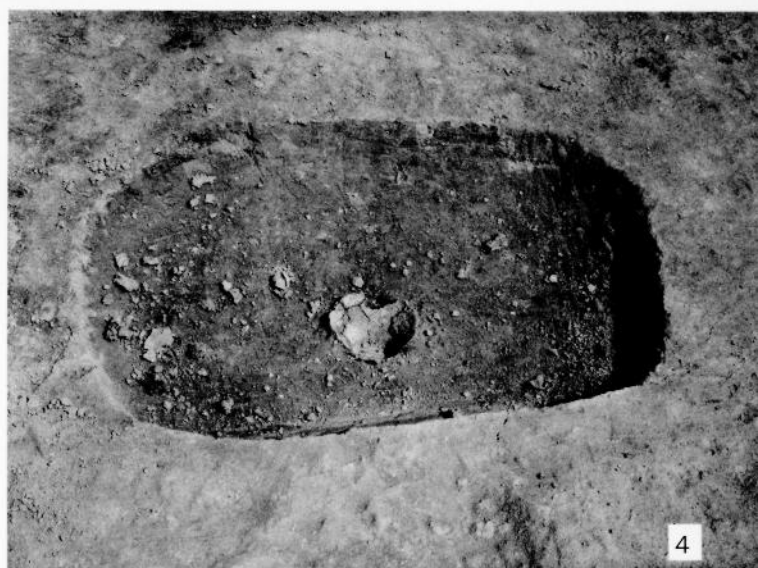

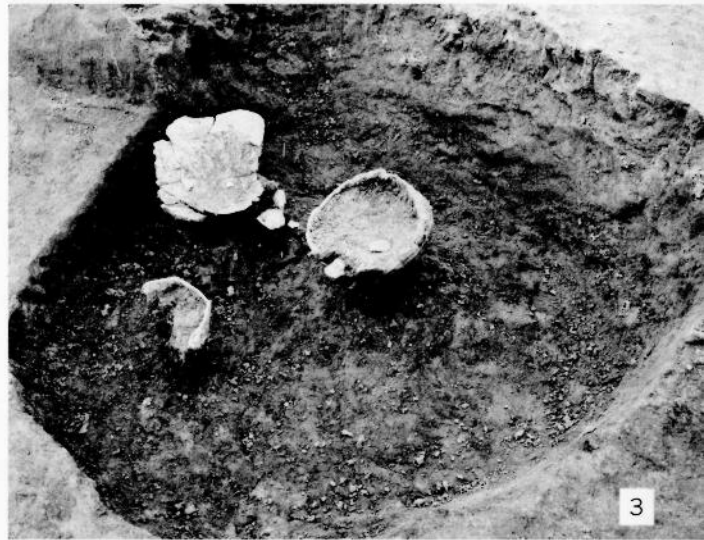
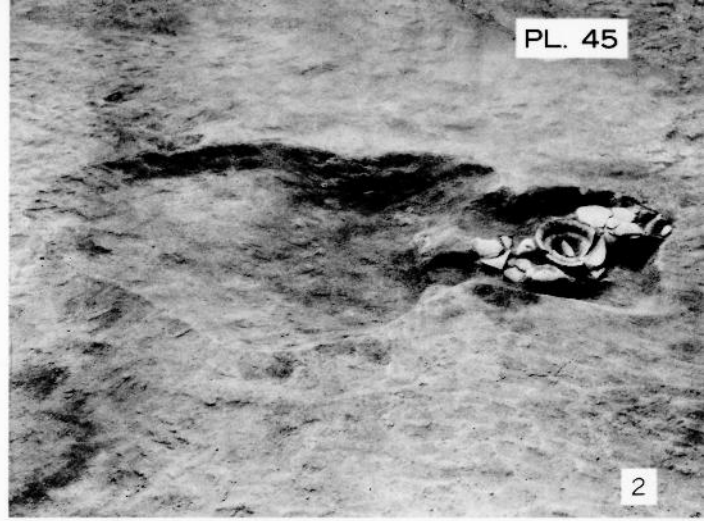

## 古墳時代の遺構

1. 土壇SK7080・7088を  
中心とした小穴群 東から
4. 溝SD6060北部 南から

2. 土壇SK7088 北東から
3. 土壇SK7098 東から
5. 同上 中央部 西北から







9

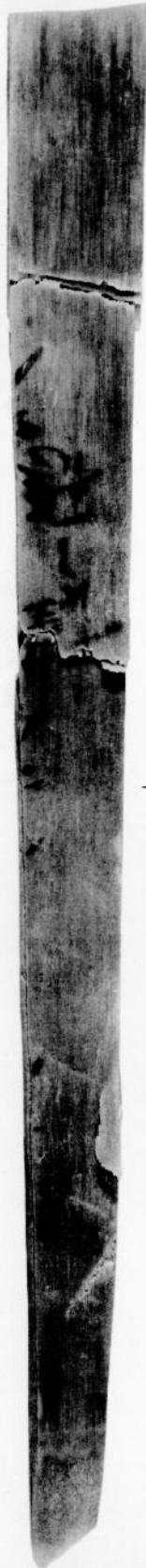

1



3



2



8

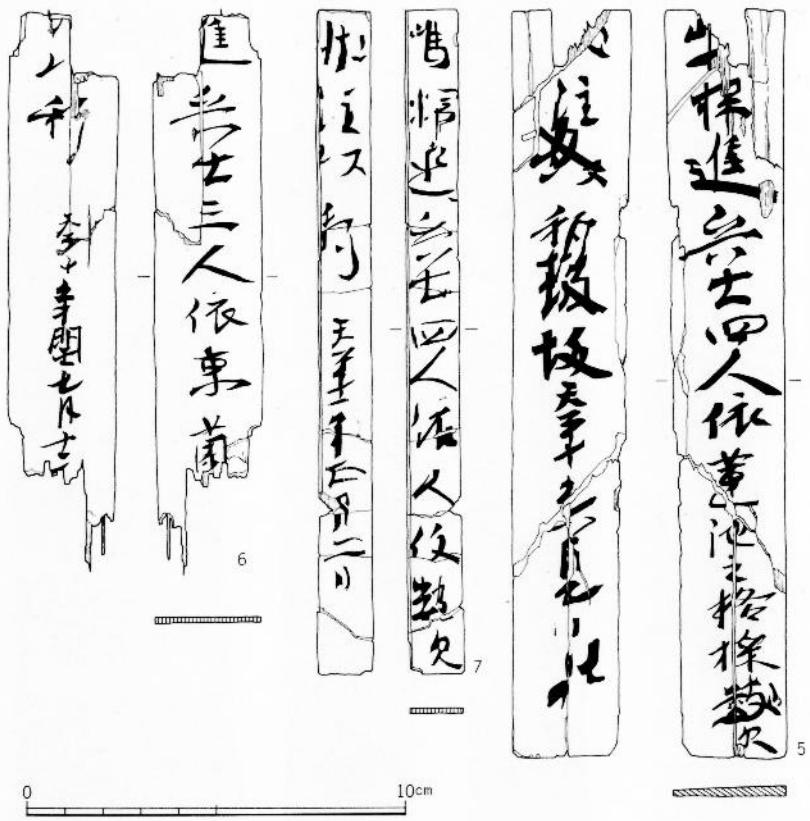

5.  嶋 進兵士四人依蓮池之格採數欠

•  狀注「坂」以移「坂坂」天平十年六月九日

7. 嶋掃進兵士四人依人役數欠

• 狀注以移 天平十一年正月三日

6.  進兵士三人依東園

•  以移 天平十年閏七月十二日

人形  
 新  
 年  
 正月  
 廿  
 日  
 進  
 出  
 三  
 人  
 依  
 事  
 麻

6

進  
 出  
 三  
 人  
 依  
 事  
 麻

7

進  
 出  
 三  
 人  
 依  
 事  
 麻

5

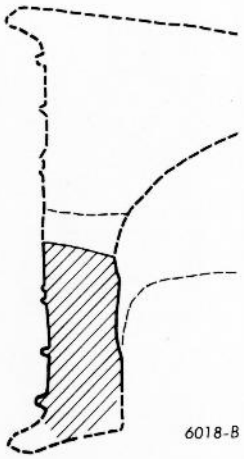

6018-B

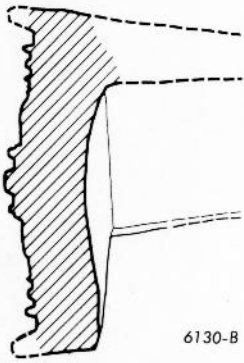

6130-B

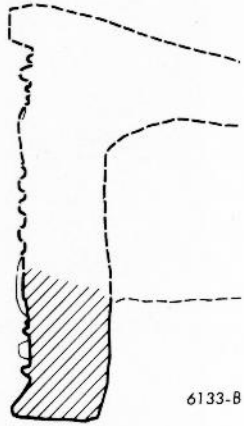

6133-B

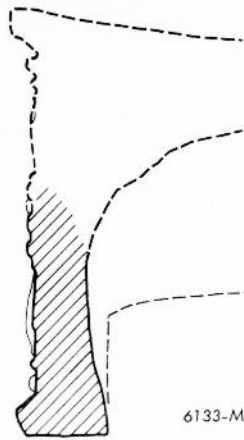

6133-M

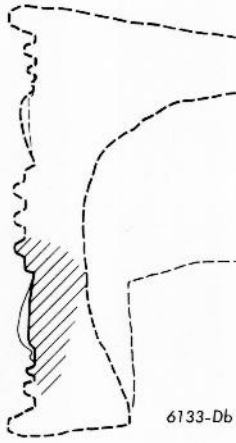

6133-Db

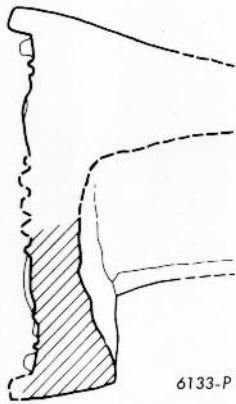

6133-P

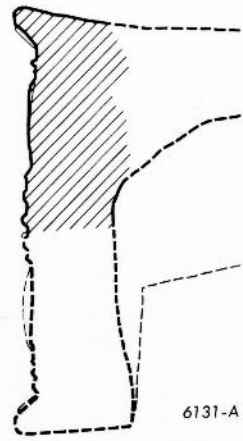
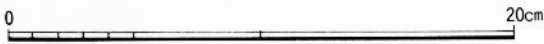

6131-A

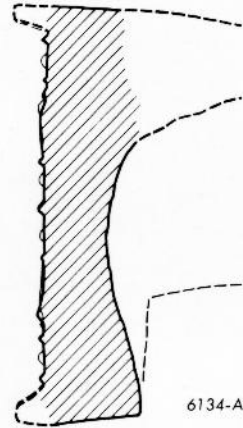

6134-A

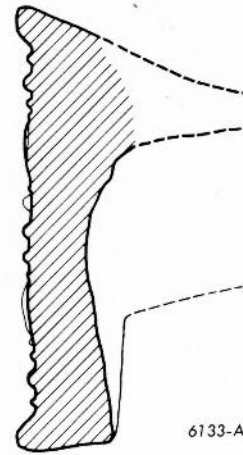

6133-A

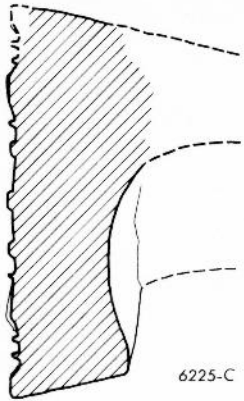

6225-C

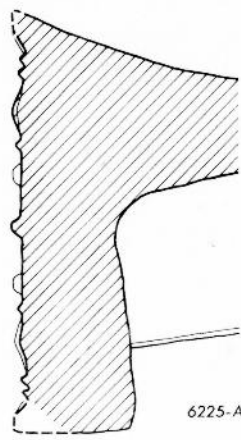

6225-A



6018B



6131A



6130B



6134A



6133B



6133Db



6133M



6133P



6133A



6225C



6225A

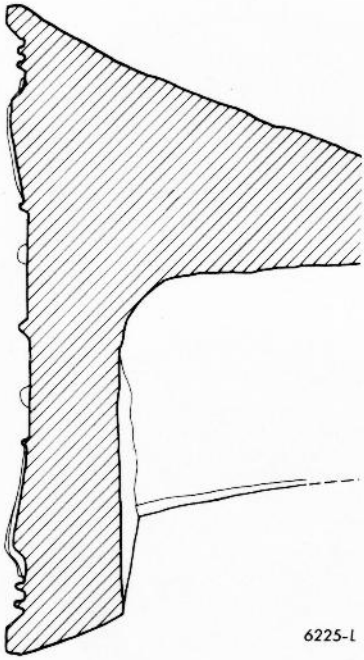

6225-L

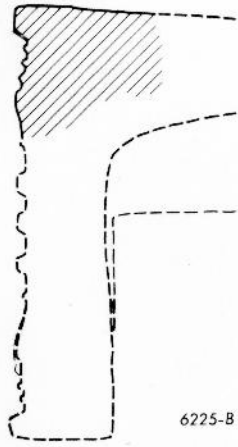

6225-B

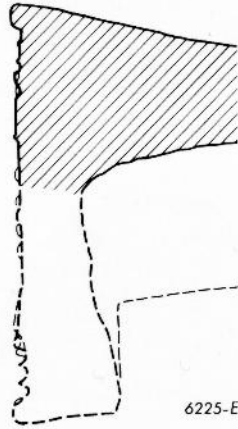

6225-E

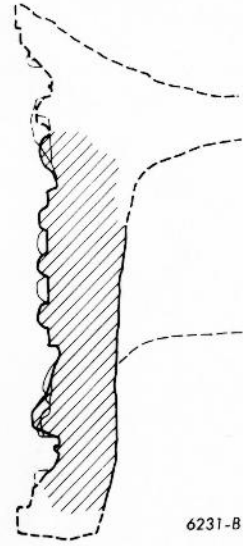

6231-B

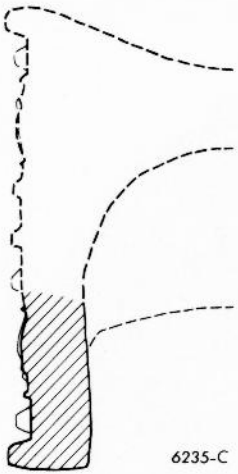

6235-C

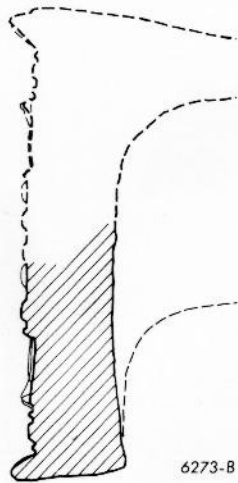

6273-B

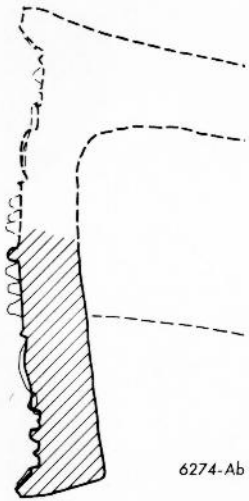

6274-Ab

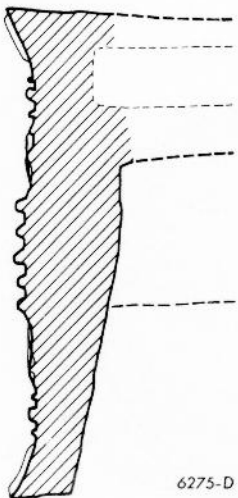

6275-D

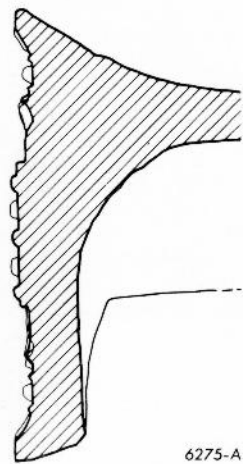
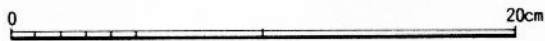

6275-A



6225B



6225E

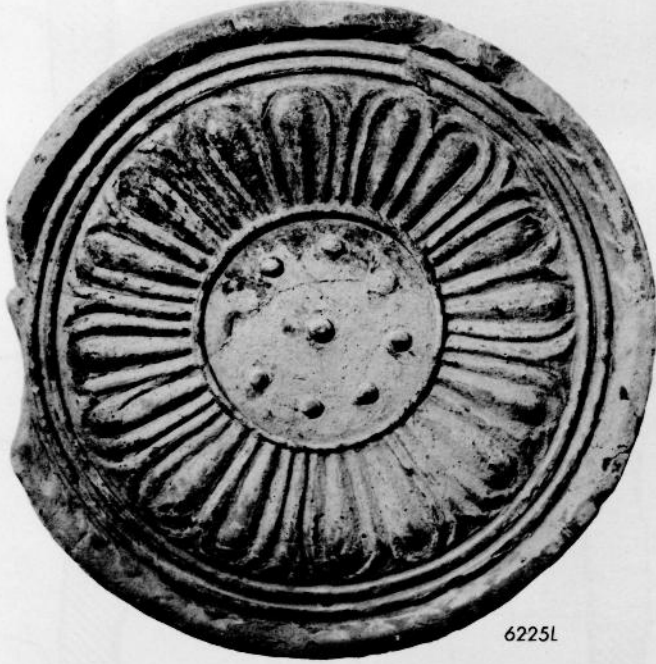

6225L



6231B



6235C



6273B



6274Ab



6275D



6275A

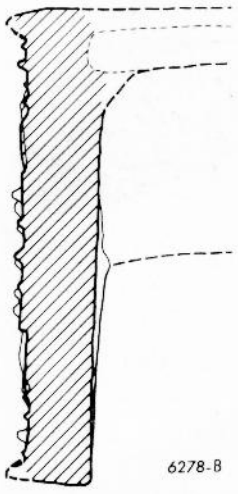

6278-B

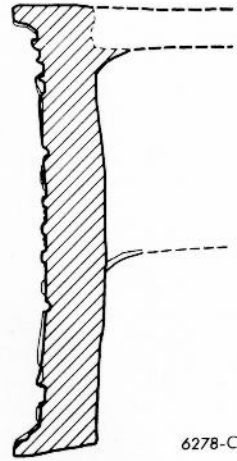

6278-Cb

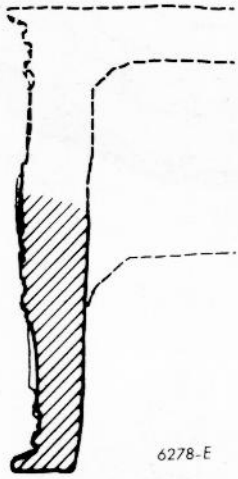

6278-E

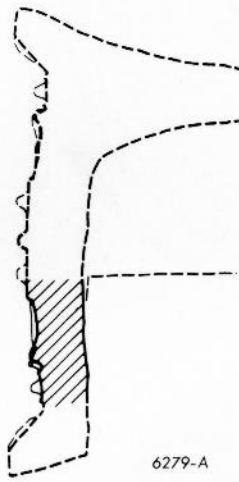

6279-A

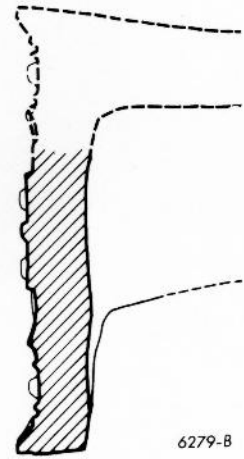

6279-B

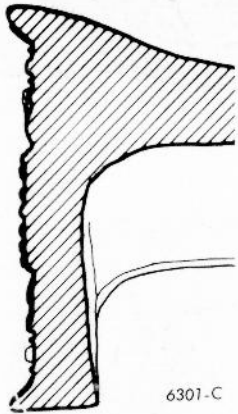

6301-C

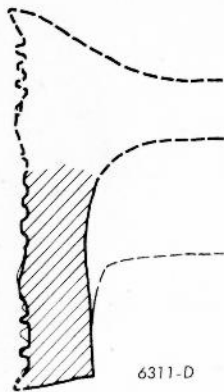
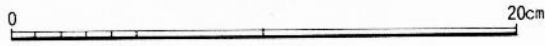

6311-D

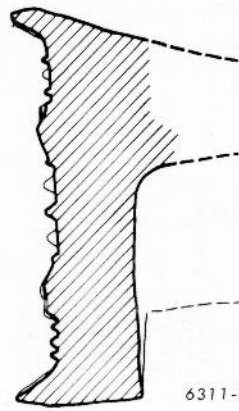

6311-B

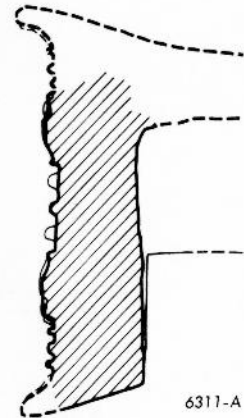

6311-A





6278B

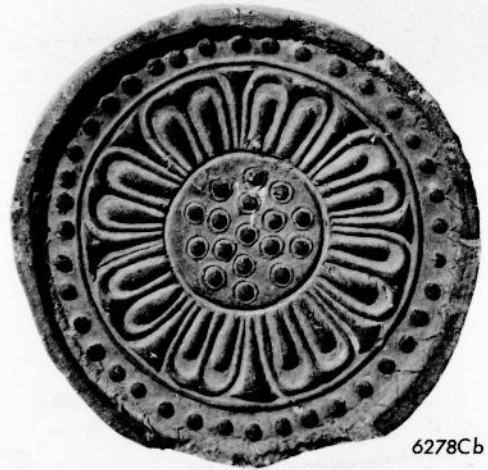

6278Cb



6278E



6279A



6279B



6301C



6311A



6311D



6311B



6308D



6308A



6313A



6313B



6313C



6281B



6281Ab



6282Ba



6282Db

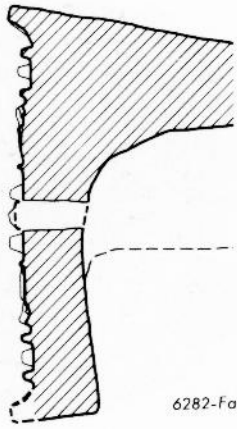

6282-Fa

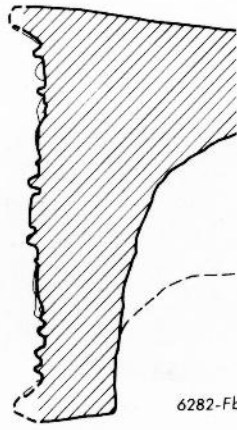

6282-Fb

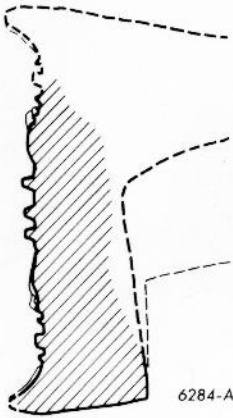

6284-A

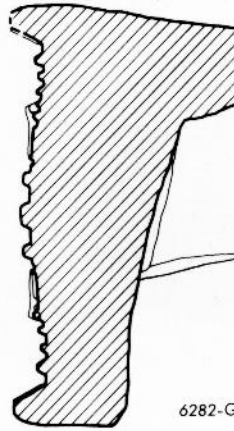

6282-G

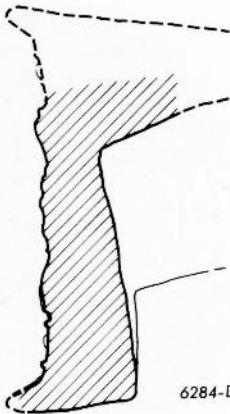

6284-D

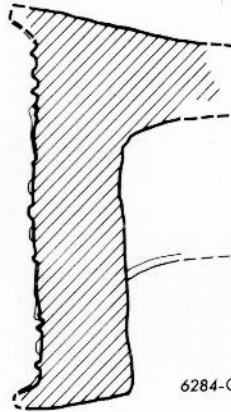

6284-C

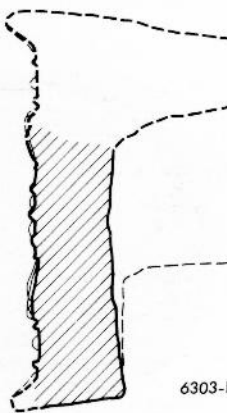

6303-B

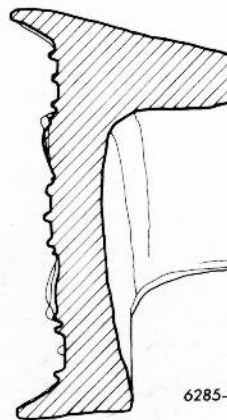

6285-A





6282Fa



6282Fb



6284A



6282G



6284D



6284C



6303B



6285A

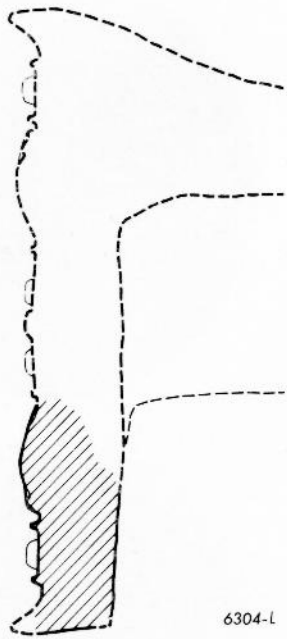

6304-L

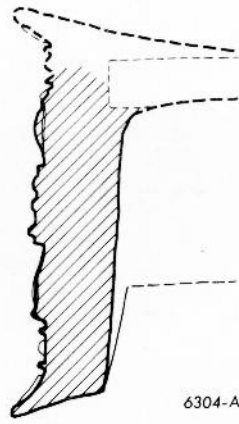

6304-A

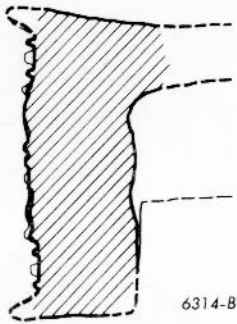

6314-B

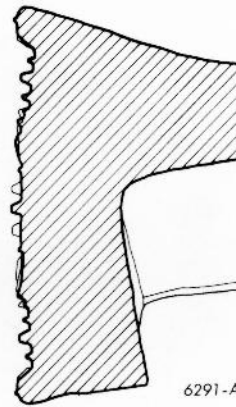

6291-A

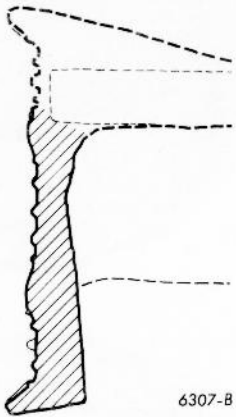

6307-B

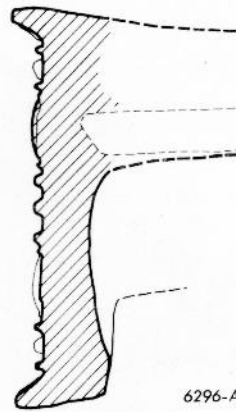

6296-A

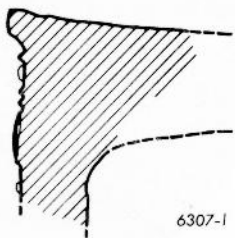

6307-I

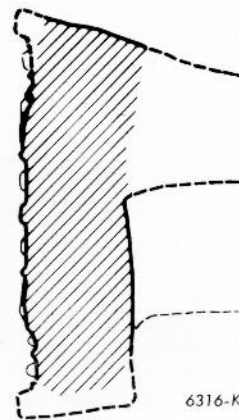

6316-K

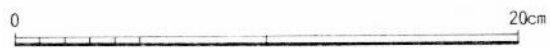



6304L



6304A



6314B



6291A



6307B



6296A



6307I



6316K

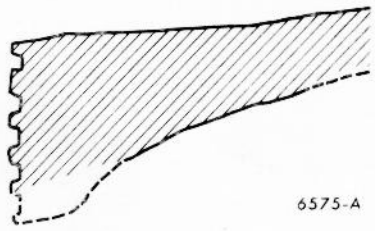

6575-A

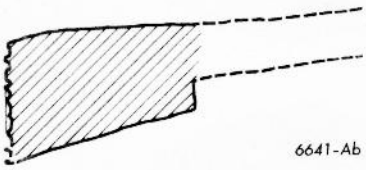

6641-Ab

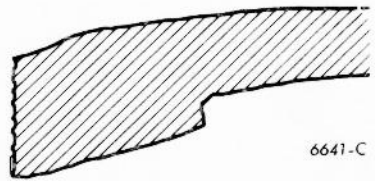

6641-C

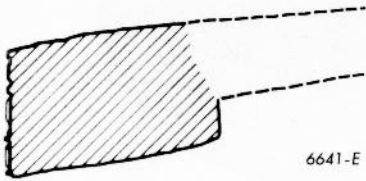

6641-E

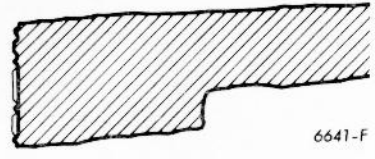

6641-F

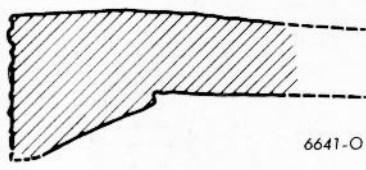
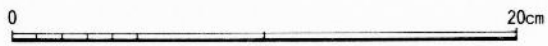

6641-O

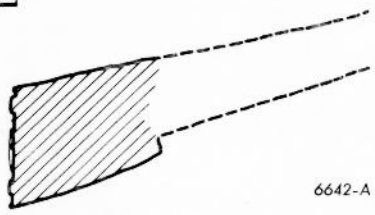

6642-A

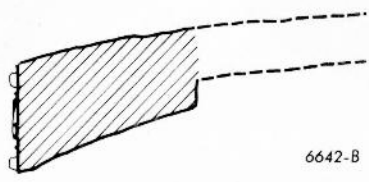

6642-B

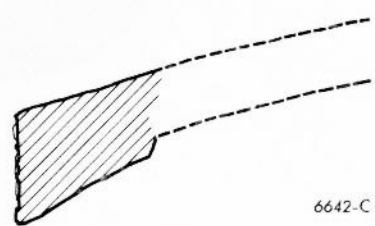

6642-C

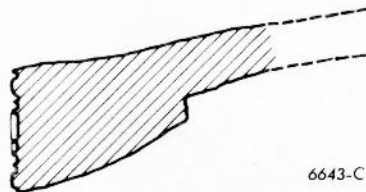

6643-C

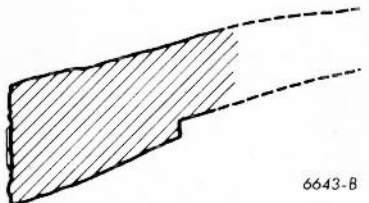

6643-B



6643-Aa

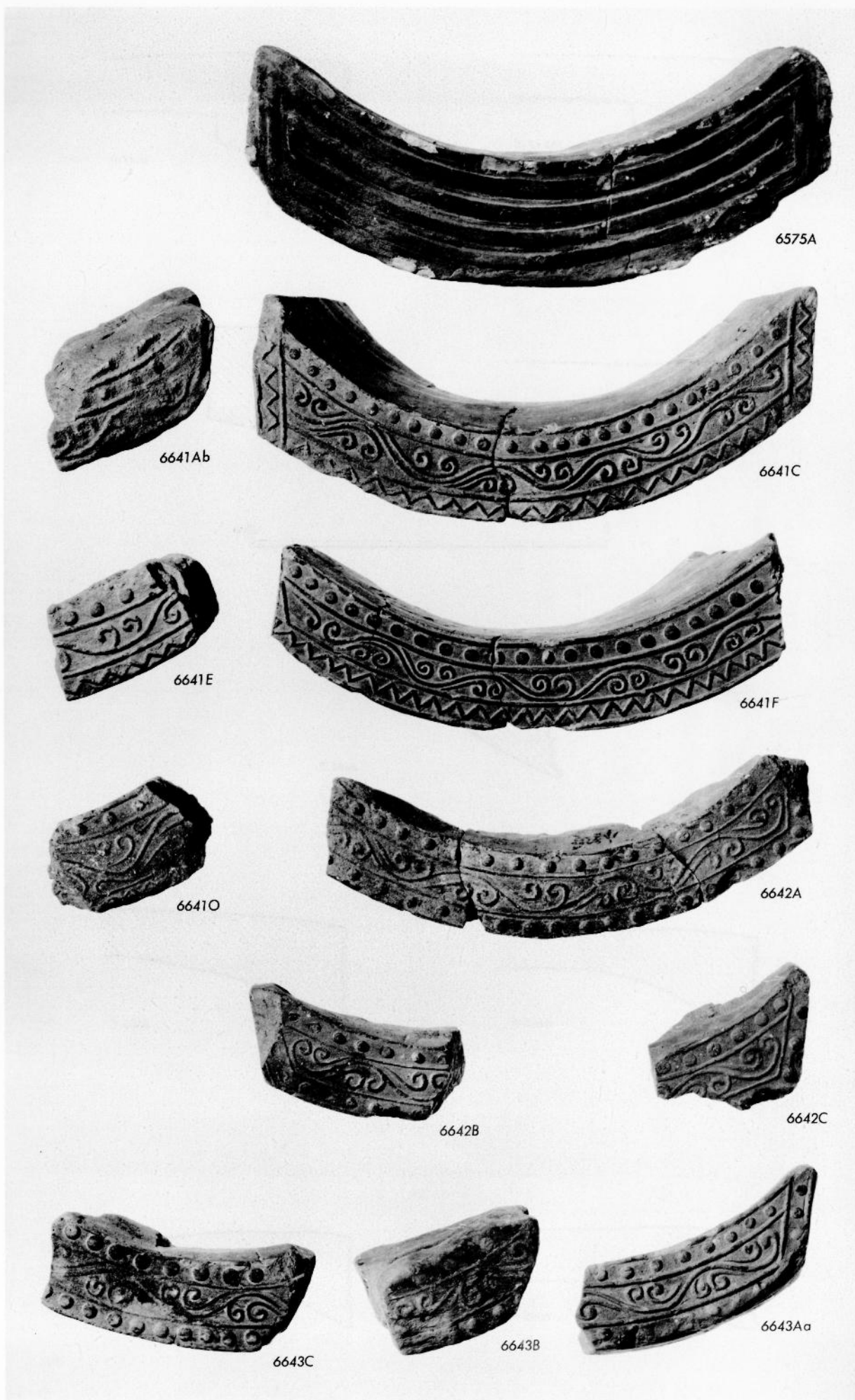





6647-C

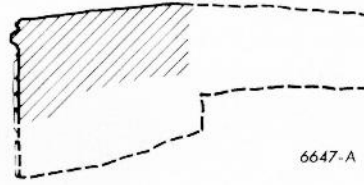

6647-A

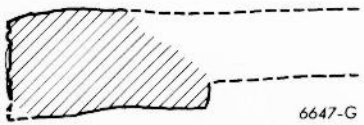

6647-G

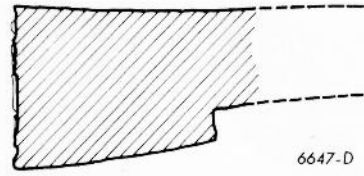

6647-D

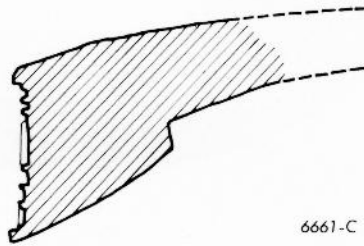
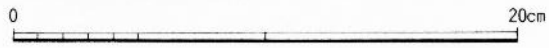

6661-C

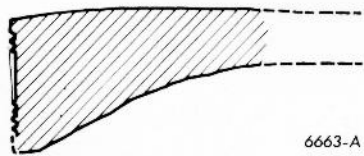

6663-A

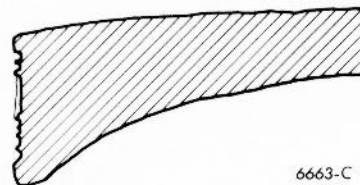

6663-C

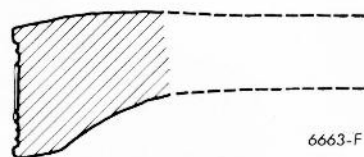

6663-F

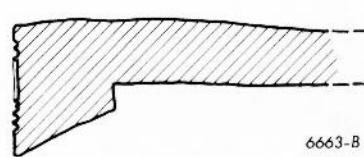

6663-B



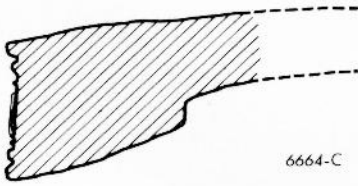

6664-C

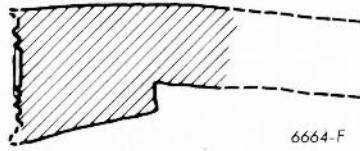

6664-F



6664-Ga

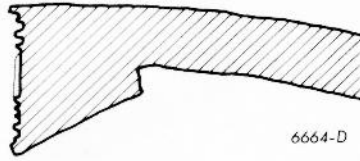

6664-D

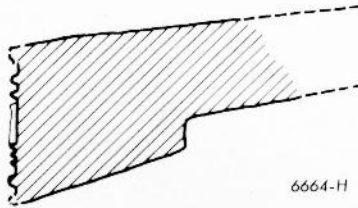

6664-H

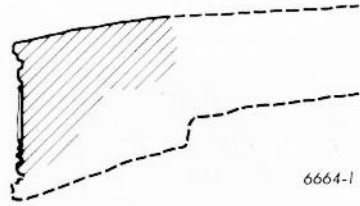

6664-I



6666-A

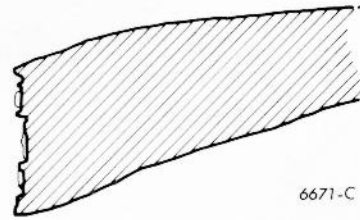

6671-C

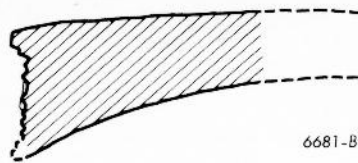

6681-B

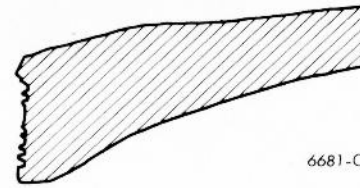

6681-C

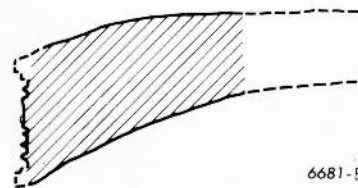

6681-E

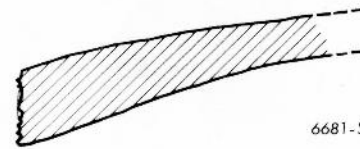

6681-S





6664C



6664F



6664Ga



6664D



6664H



6664I



6666A



6671C



6681B



6681C



6681E



6681S



6681S

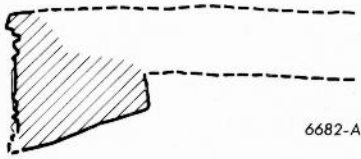

6682-A

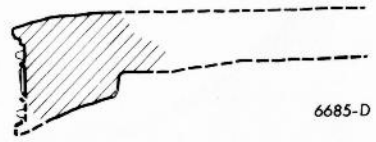

6685-D



6704-A



6694-A



6691-A

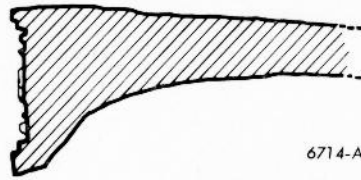

6714-A

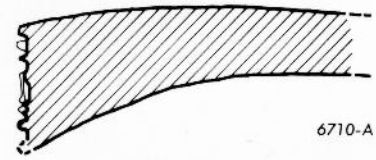

6710-A

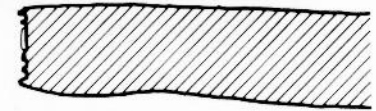

6719-A

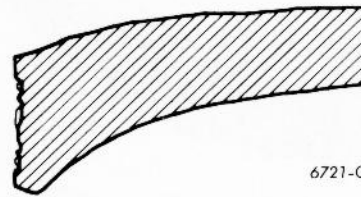

6721-C

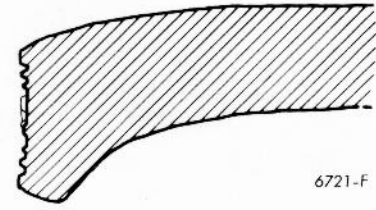

6721-F

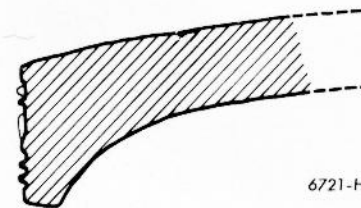

6721-H

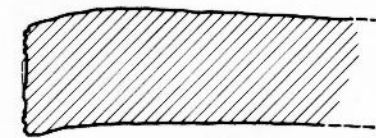

6721-Ga

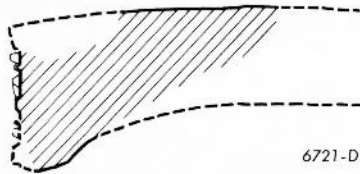

6721-D

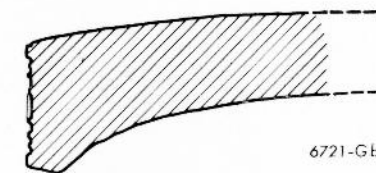

6721-Gb

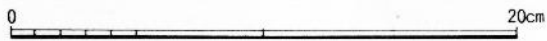



6682A



6685D



6704A



6694A



6691A



6714A



6701A



6719A



6721C



6721F



6721H



6721Ga



6721D



6721Gb

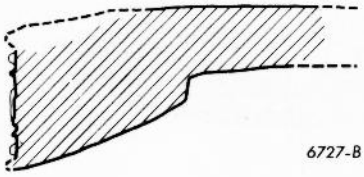

6727-B



6727-A

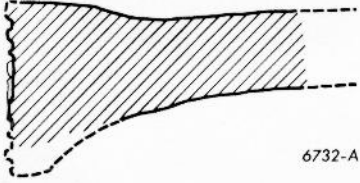

6732-A

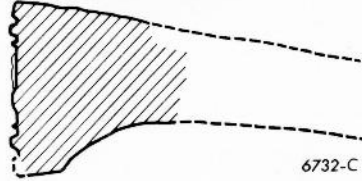

6732-C

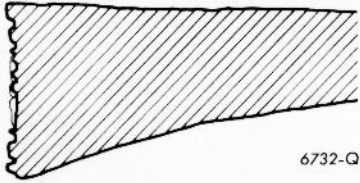

6732-Q

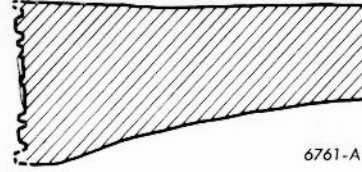

6761-A

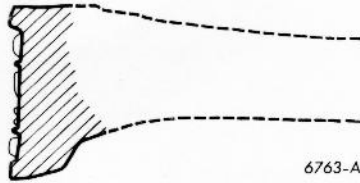

6763-A

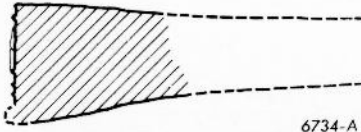

6734-A

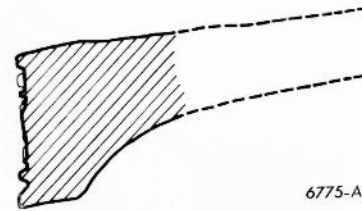

6775-A



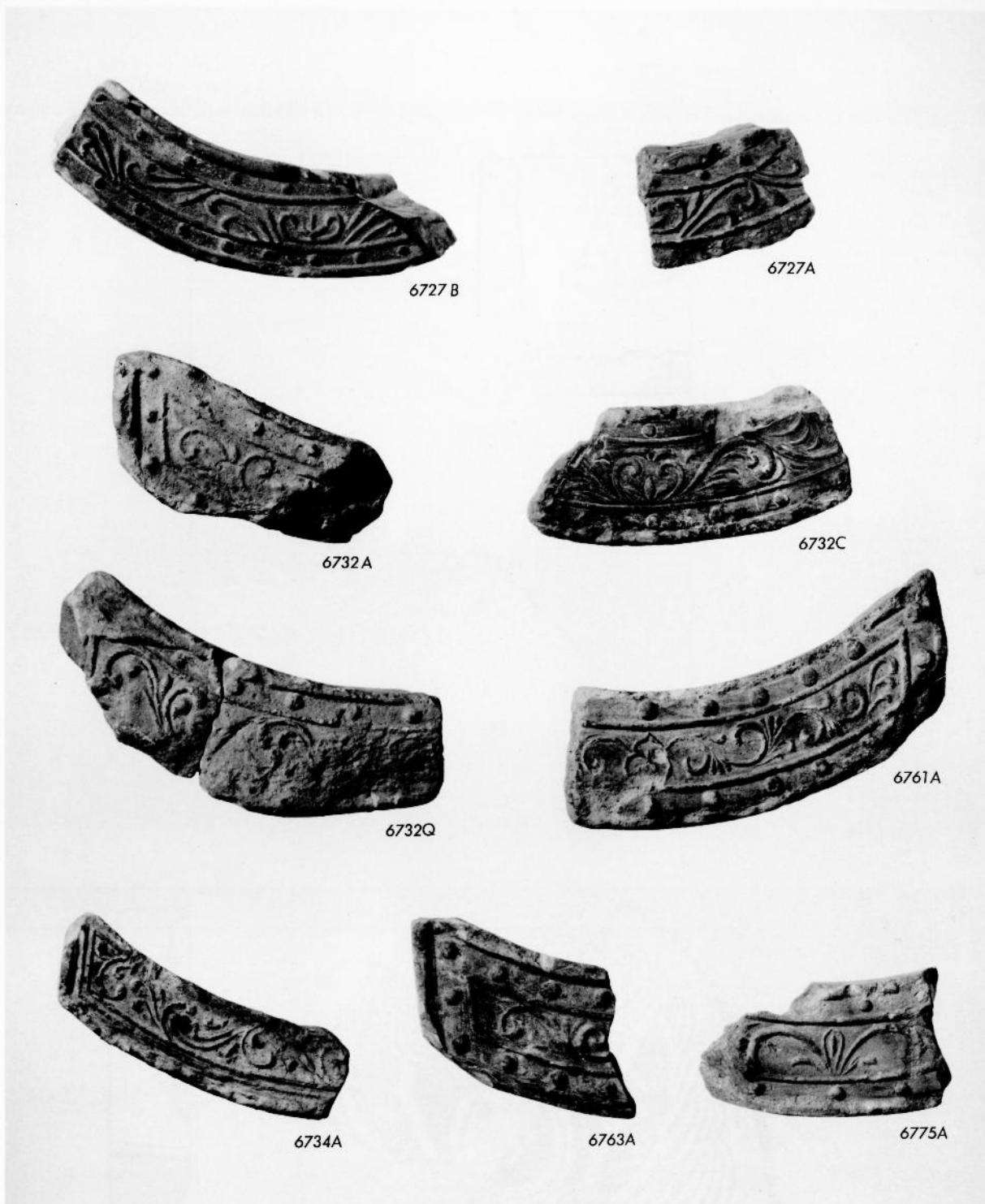



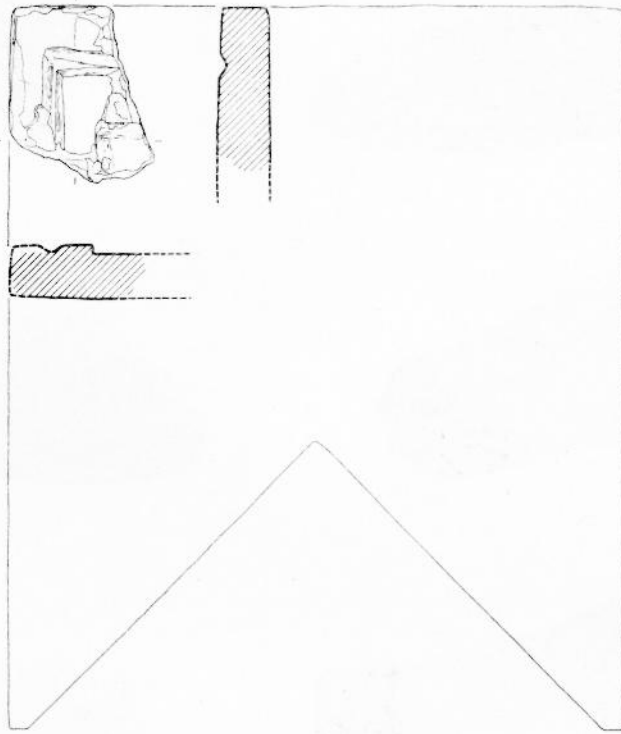

隅木蓋瓦

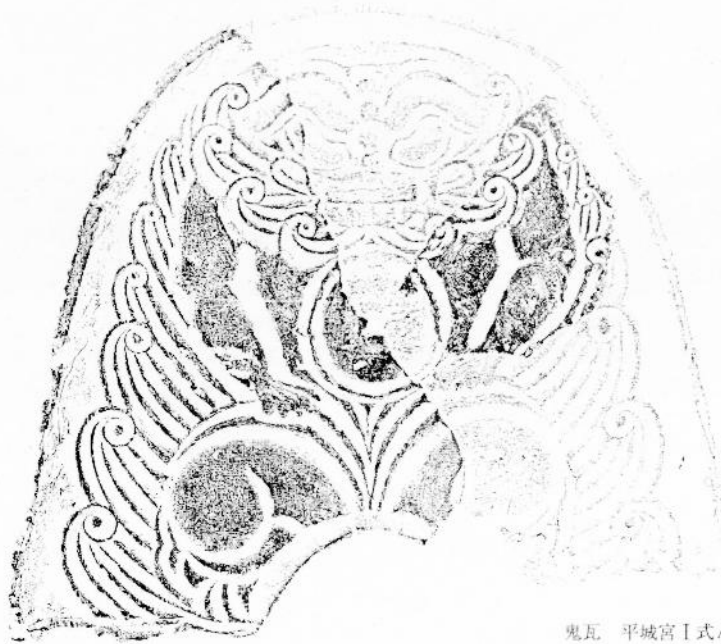

鬼瓦 平城宮I式A

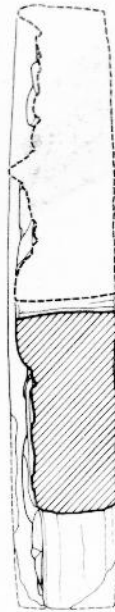

縮尺 1:5



隅木蓋瓦



鬼瓦  
平城宮Ⅱ式A1



面戸瓦



鬼瓦  
平城宮Ⅰ式A



SD 5960

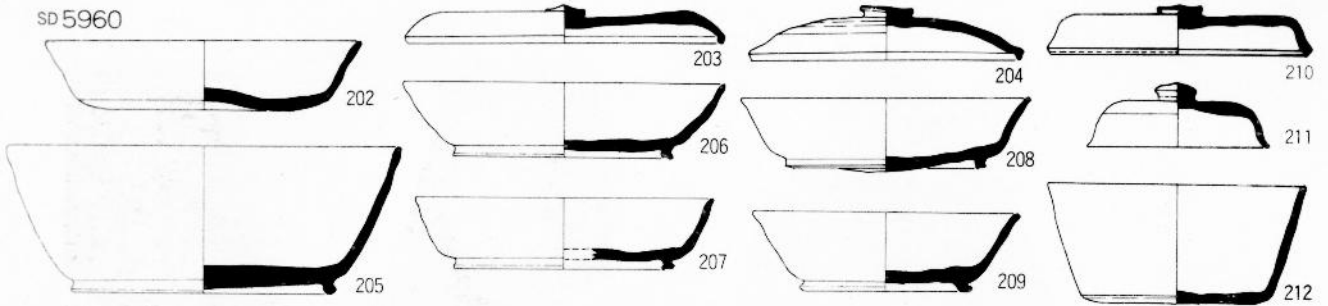

SD 6477-6499

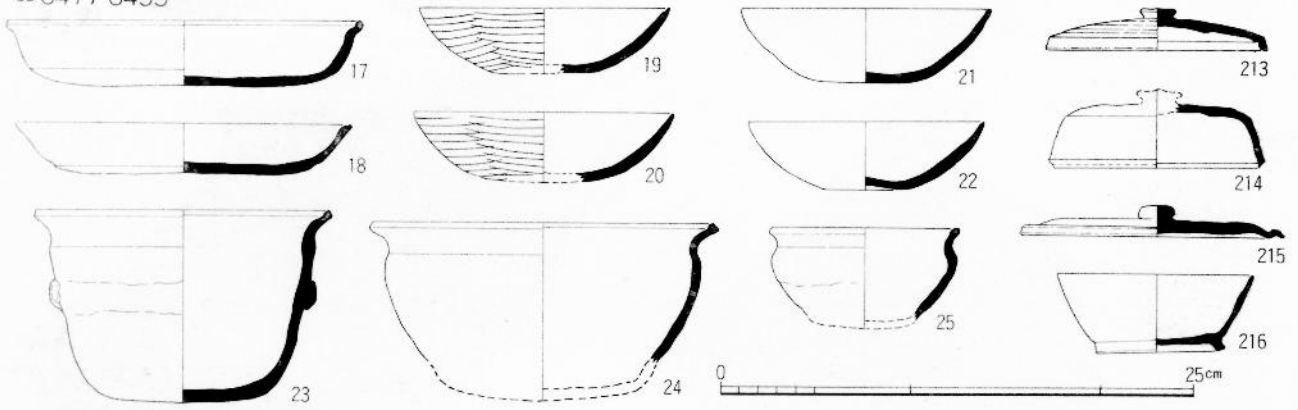

SD 6151-6152

SK 6397

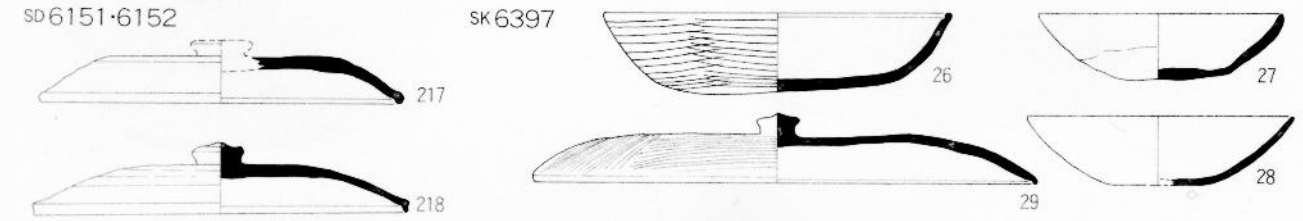

SD 6160

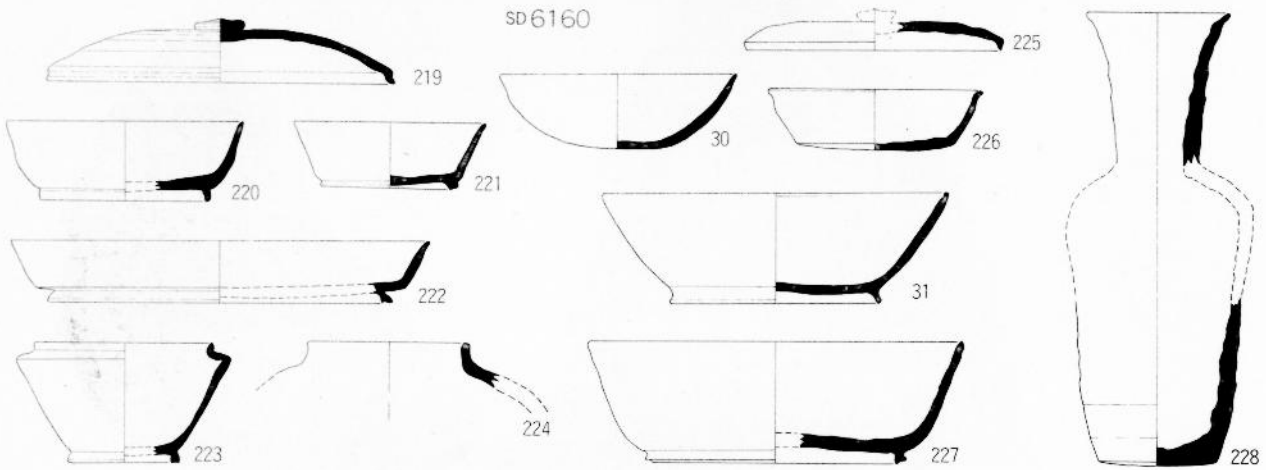

包含層

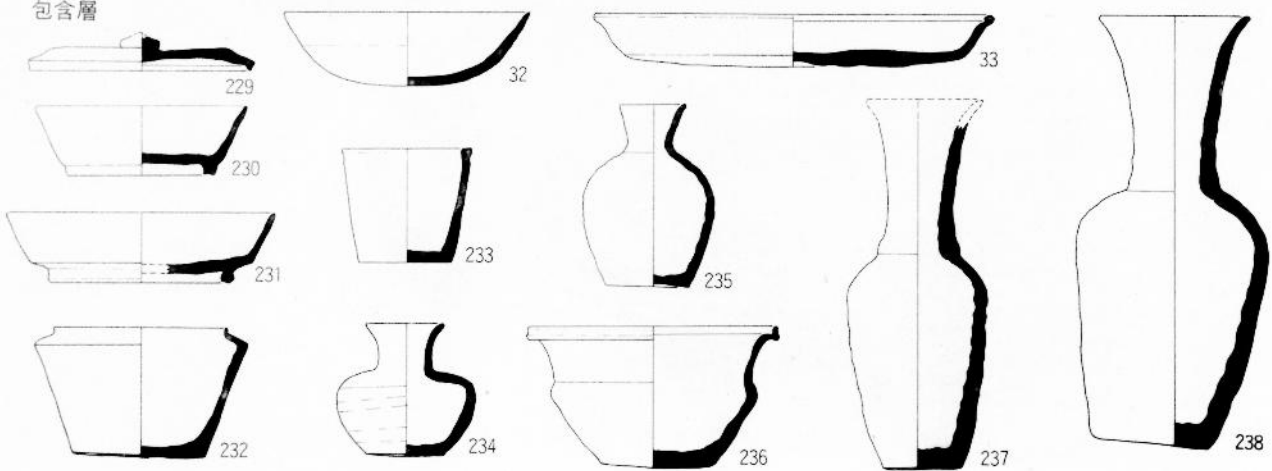

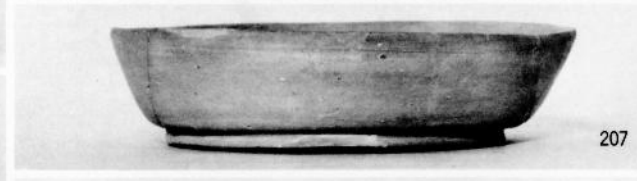
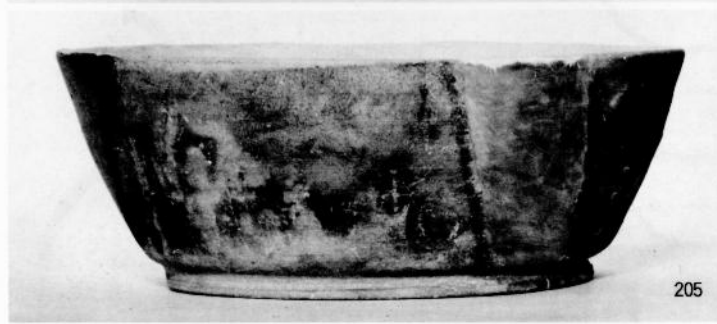
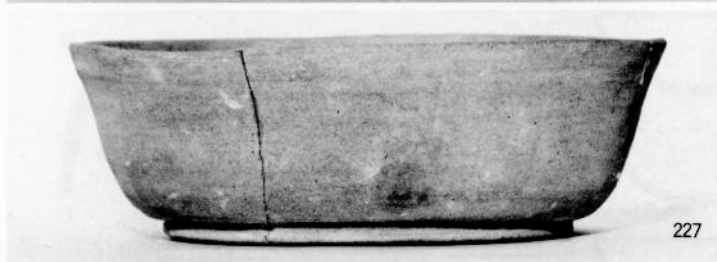

SK 6350



34

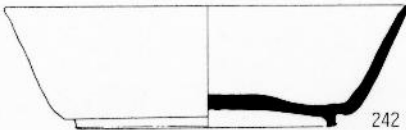

242

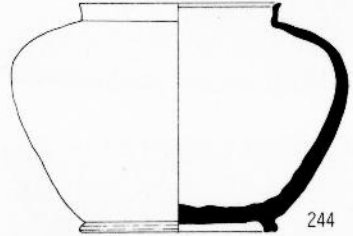

244



239

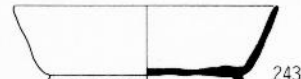

243

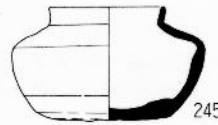

245

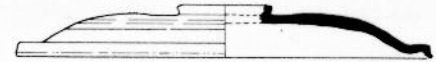

240

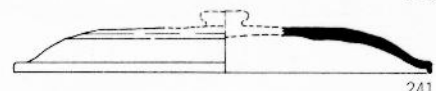

241

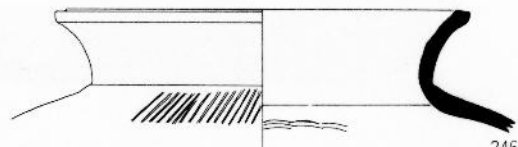

246

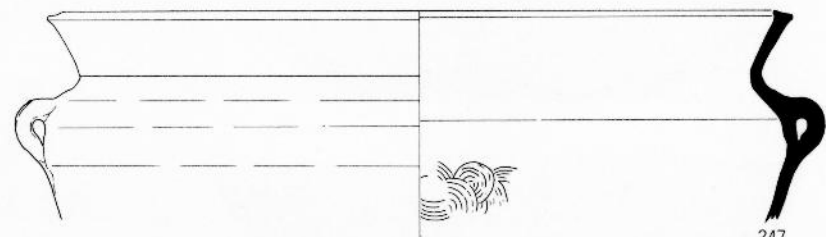

247

SE 6166



35



36



48

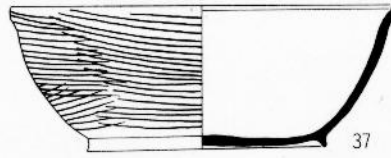

37



42



43

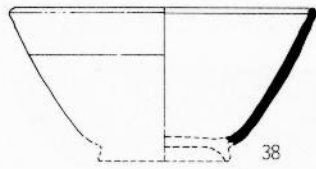

38



44



39

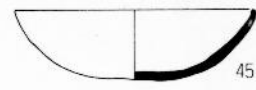

45

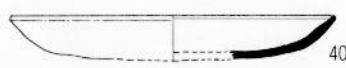

40



46



41

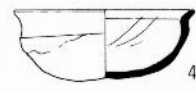

47

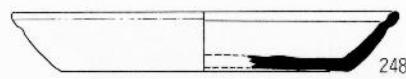

248



49

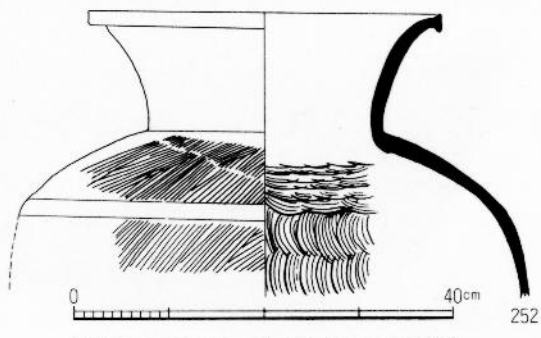

252

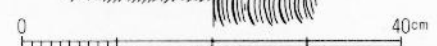

249

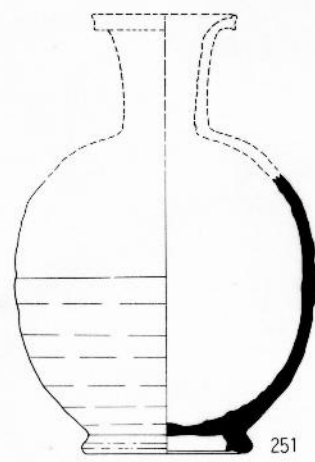

251

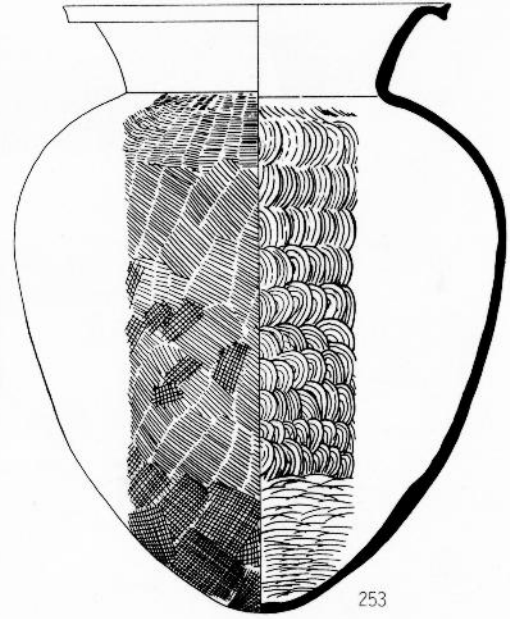

253

