

16101；大阪府垂水南，16102；大阪府安満，16103・16105・16106；奈良県唐古，16104；大阪府西岩田，16107；大阪府恩智，16108；京都府鴨田，16109；大阪府加美，16110；大阪府巨摩，16111；奈良県布留，16112；奈良県平城京下層，16113；奈良県平城宮下層，16114；兵庫県播磨長越，16115；大阪府陵南北

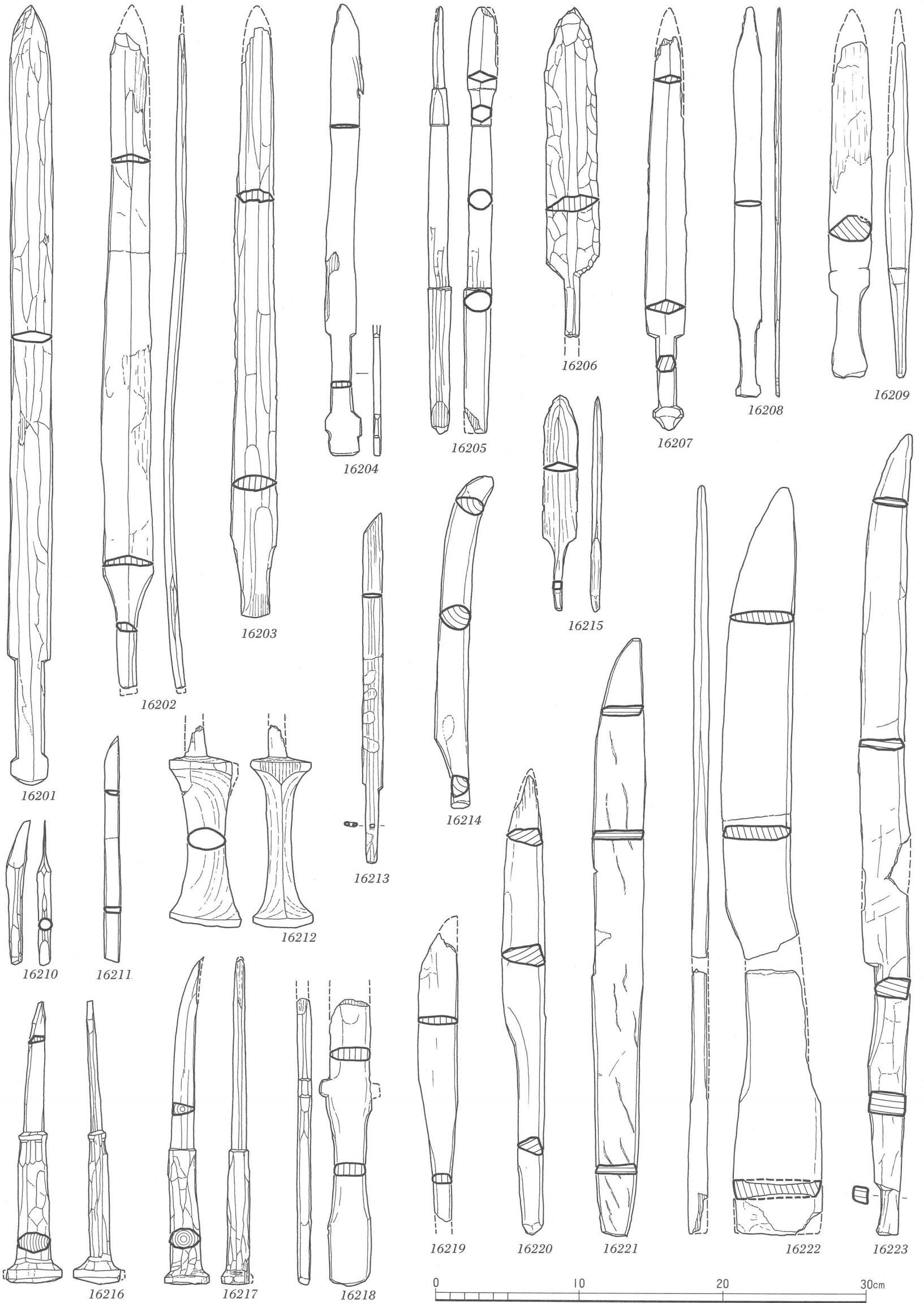

16201・16208；大阪府豊中，16202・16203・16218；奈良県平城宮下層，16204；奈良県黒田池，16205；大阪府亀井，16206；滋賀県赤野井湾，16207；滋賀県入江内湖(行司町地区)，16209；滋賀県国友，16210・16211；滋賀県湖西線，16212；京都府中久世，16213；滋賀県吉身中，16214；京都府石本，16215；奈良県谷，16216・16217・16222・16223；大阪府鬼虎川，16219；奈良県布留，16220；大阪府長原，16221；兵庫県新方

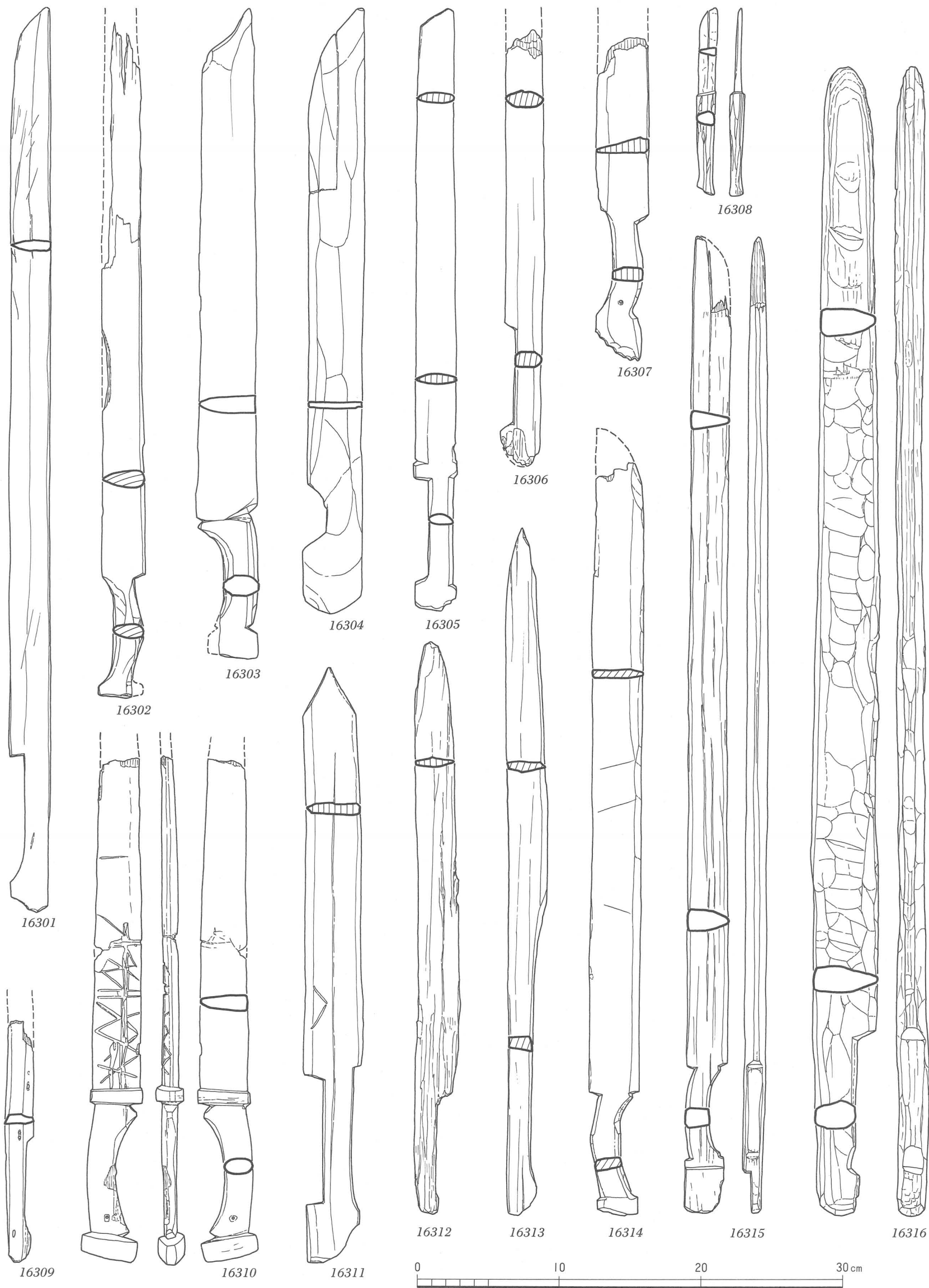

16301・16303；大阪府豊中，16302・16306；京都府鴨田，16304；大阪府美園，16305；滋賀県入江内湖(行司町地区)，
16307；滋賀県赤野井湾，16308・16311；三重県北堀池，16309・16313；大阪府陵南北，16310；滋賀県鴨田，16312；
滋賀県国友，16314；滋賀県服部，16315・16316；奈良県谷

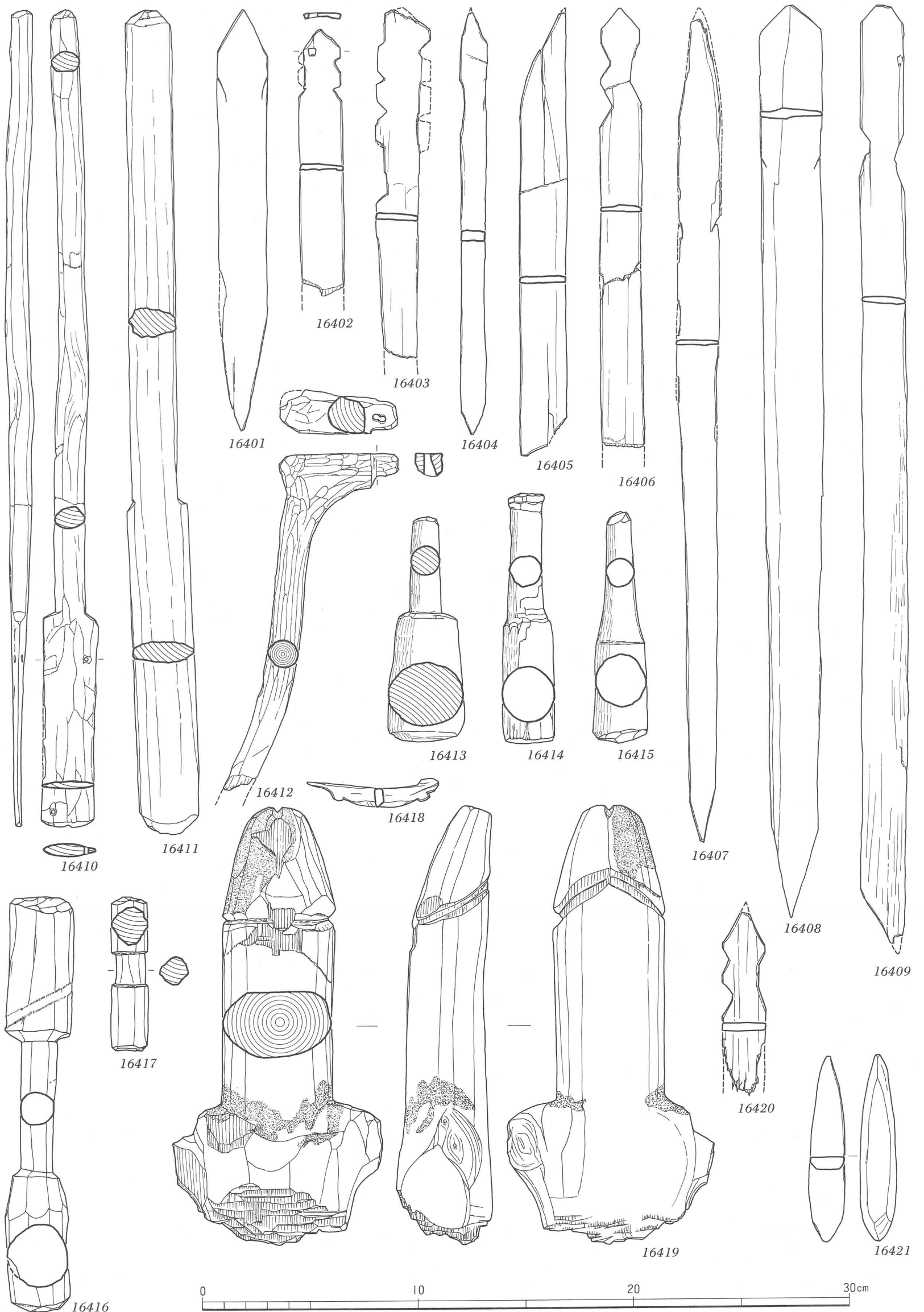

16401；奈良県和爾・森本，16402；大阪府ニサンザイ古墳，16403～16406・16416・16420・16421；滋賀県湖西線，16407
 ・16408；京都府深草坊町，16409；大阪府山賀，16410；奈良県布留，16411；滋賀県森浜，16412；大阪府西岩田，16413
 ；和歌山県鳴神Ⅴ，16414；滋賀県妙楽寺，16415；京都府中久世，16417；奈良県平城京下層，16418；滋賀県国友，16419
 ；大阪府池上

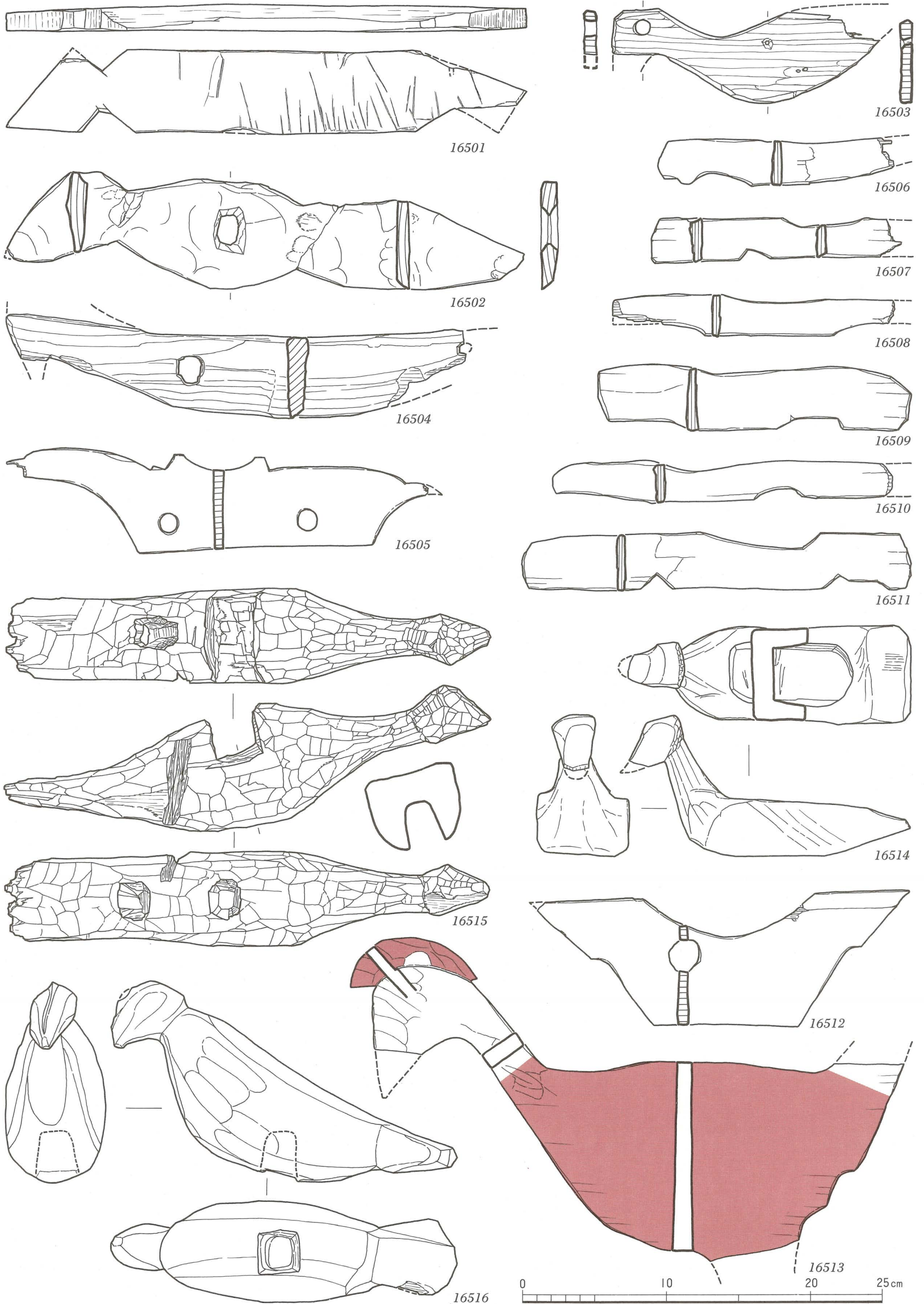

16501；大阪府瓜生堂，16502；兵庫県玉津田中，16503；兵庫県播磨長越，16504；奈良県平城京下層，16505・16512；奈良県布留，16506～16511；京都府石本，16513・16514；奈良県纏向，16515；大阪府池上，16516；大阪府亀井北

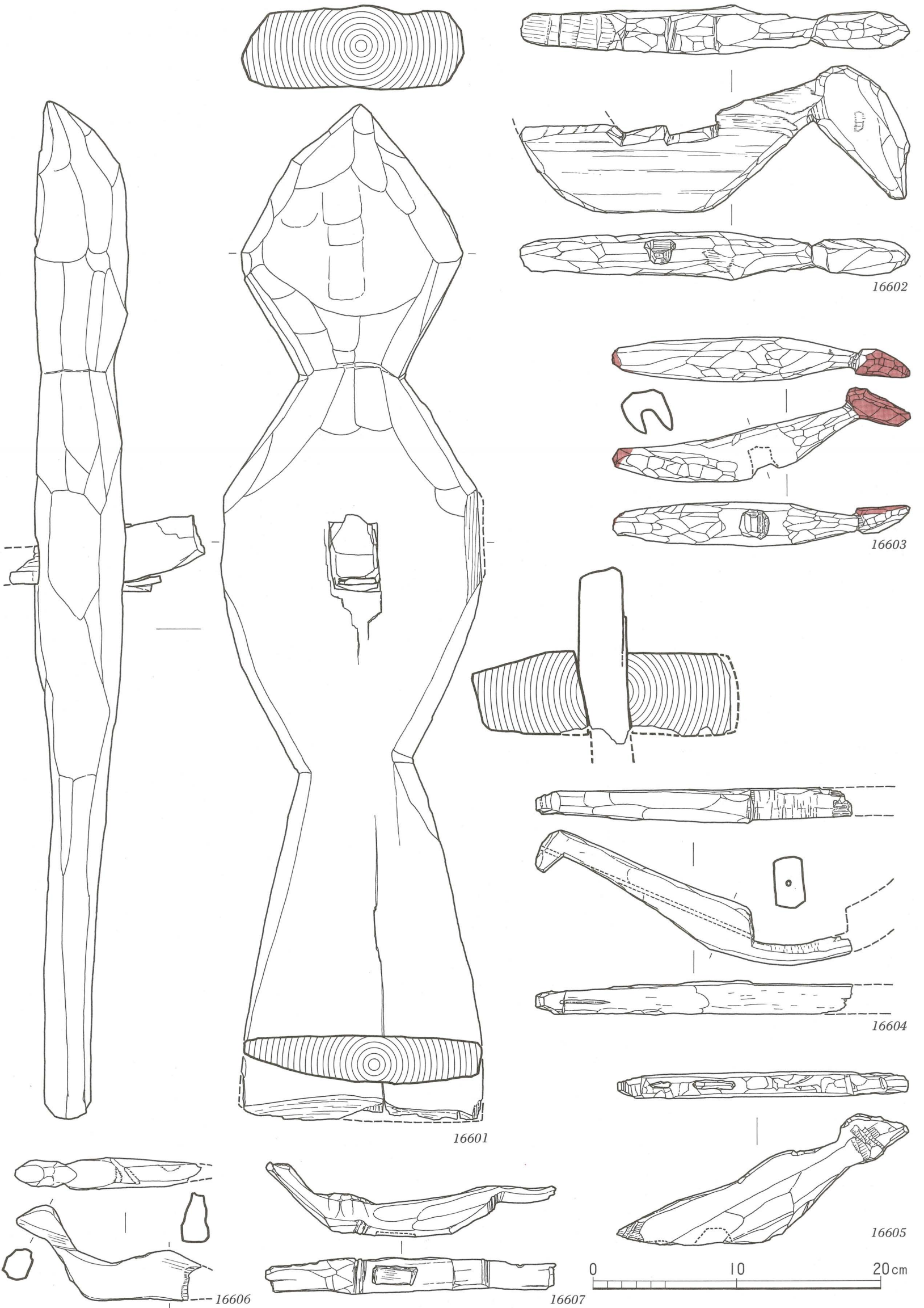

16601；兵庫県小犬丸， 16602・16603・16605・16607；大阪府池上， 16604；大阪府山賀， 16606；大阪府瓜生堂

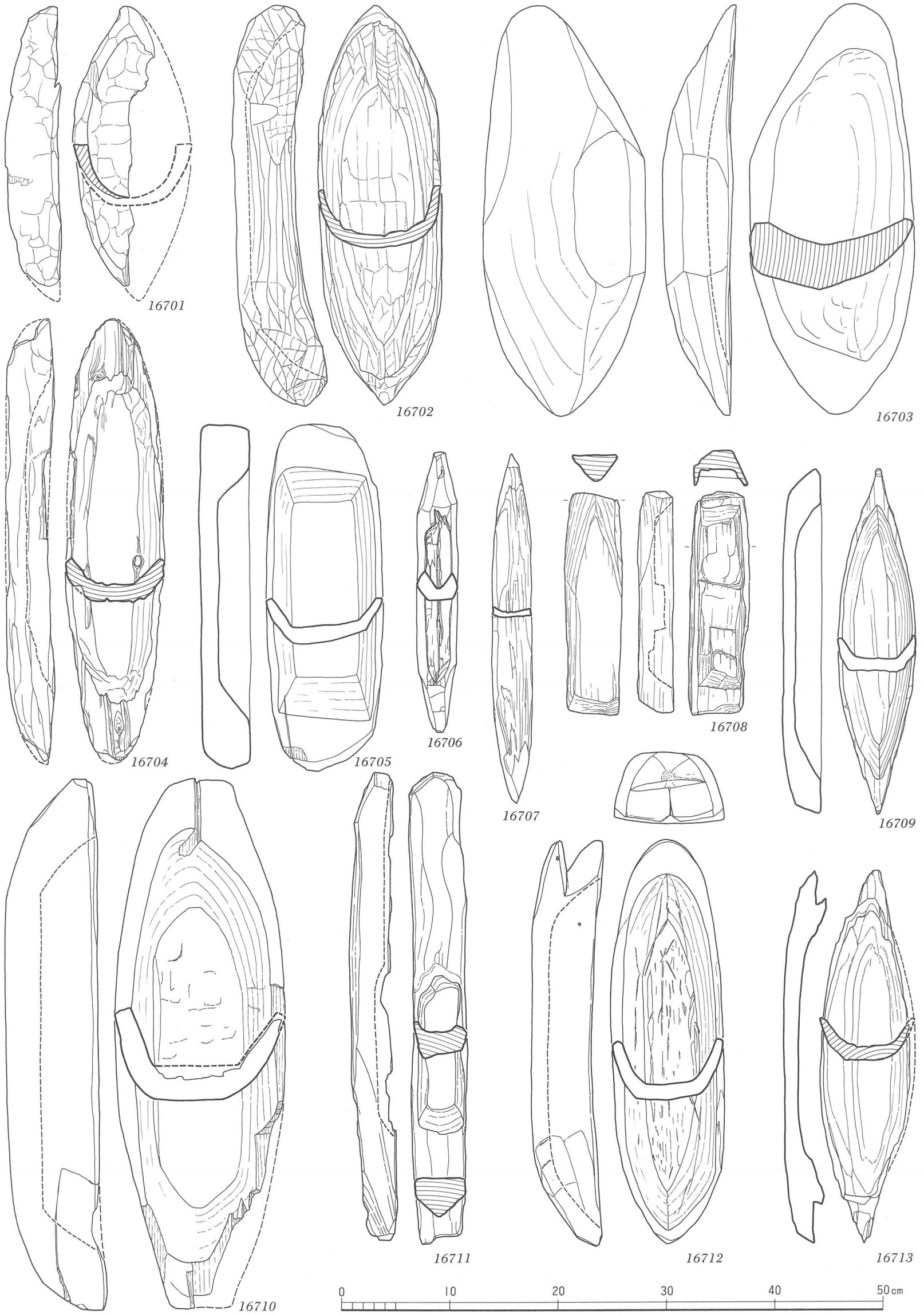

16701；兵庫県丁・柳ヶ瀬， 16702・16712；京都府古殿， 16703；大阪府鬼虎川， 16704；三重県北堀池， 16705；大阪府新家， 16706・16707；大阪府豊中， 16708・16711；京都府石本， 16709；和歌山県笠嶋， 16710；滋賀県森浜， 16713；奈良県平城京下層

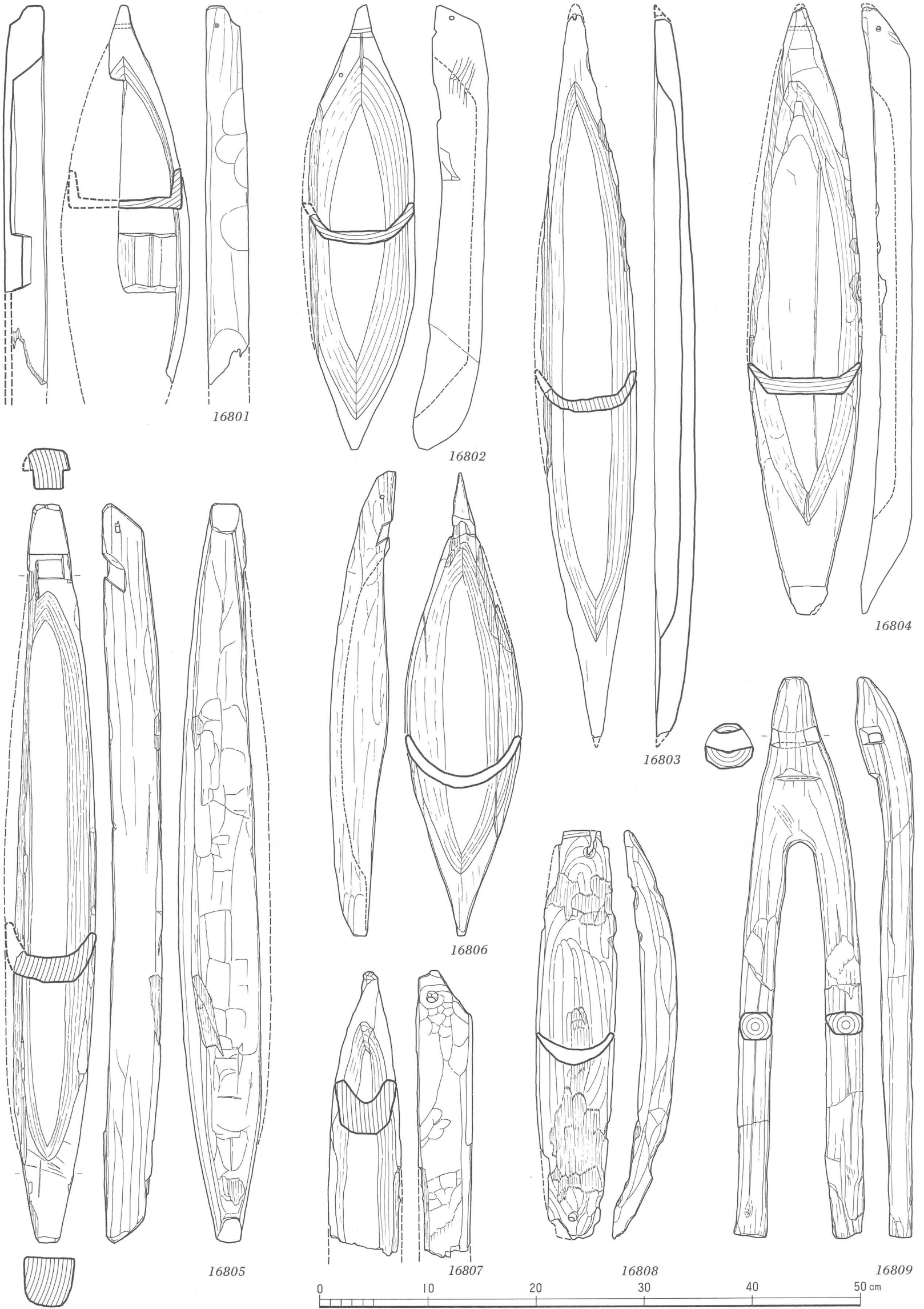

16801；兵庫県筒江片引，16802；奈良県纏向，16803；大阪府新家，16804；三重県北堀池，16805；大阪府西岩田，16806；滋賀県針江北，16807；滋賀県赤野井湾，16808；京都府正垣，16809；京都府石本

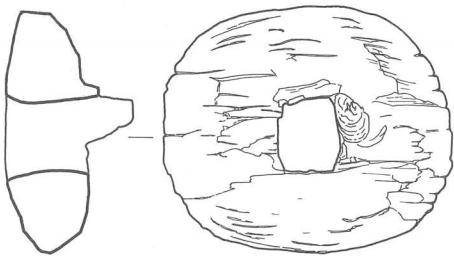
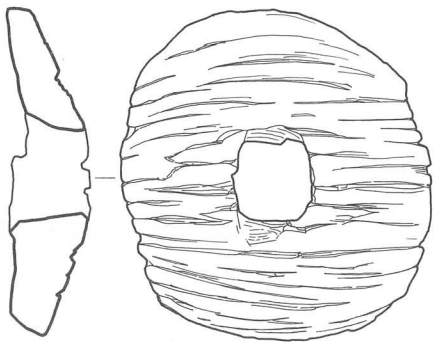
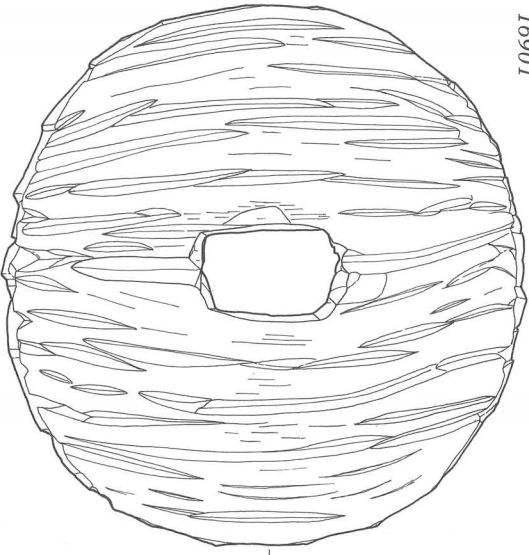
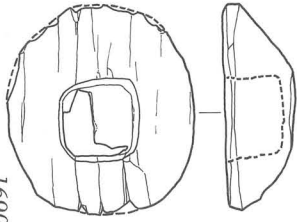
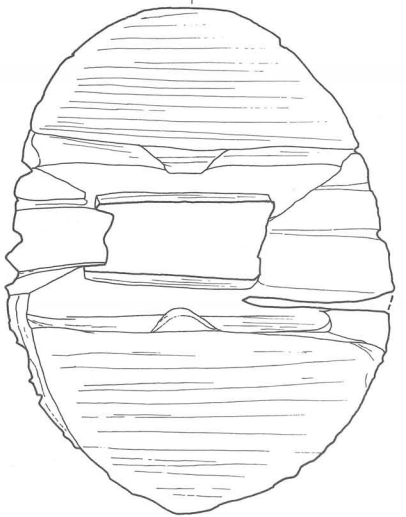
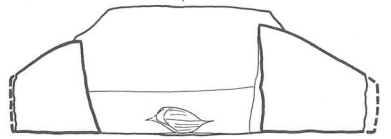
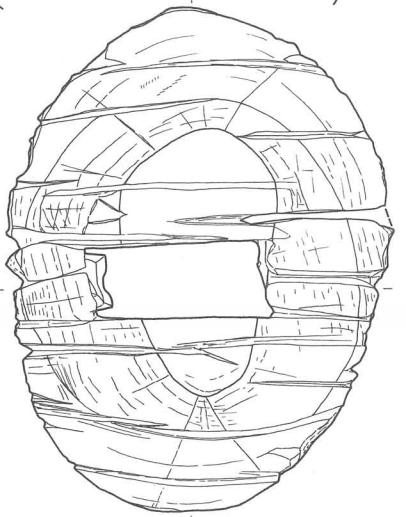
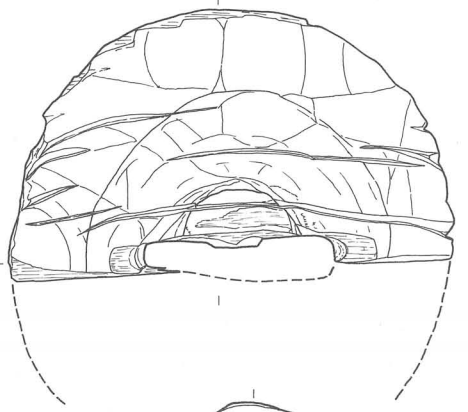

16905

16906

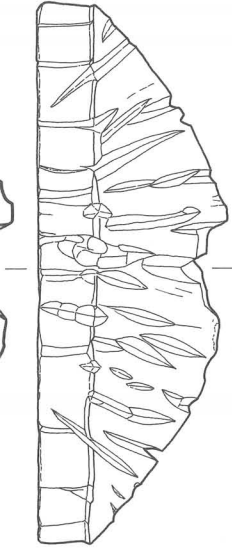
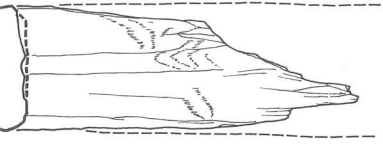

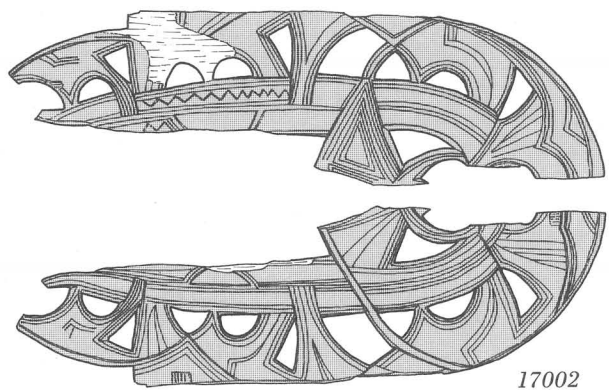

17002

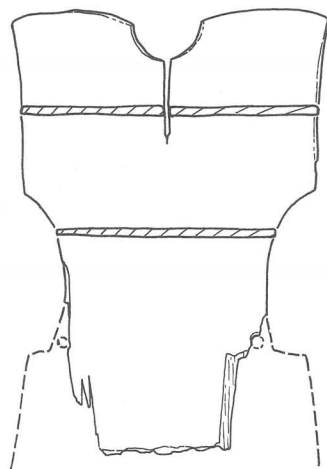

17005

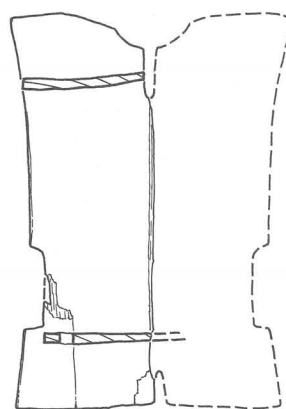

17006

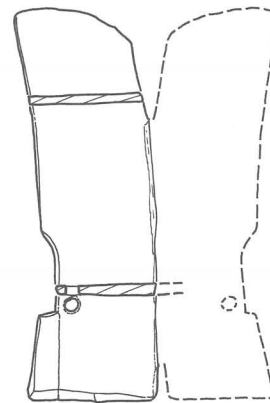

17007

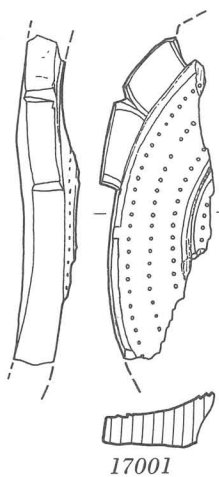

17001

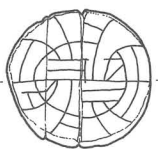

17003

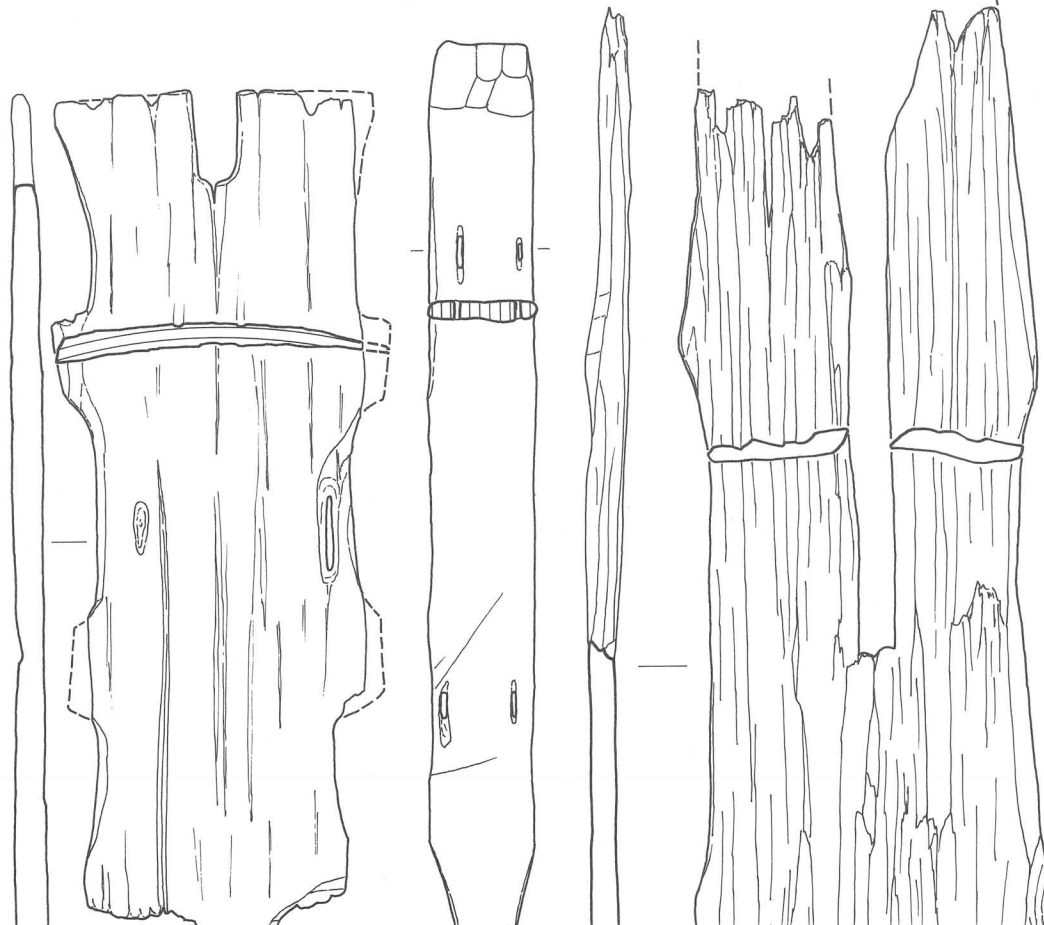
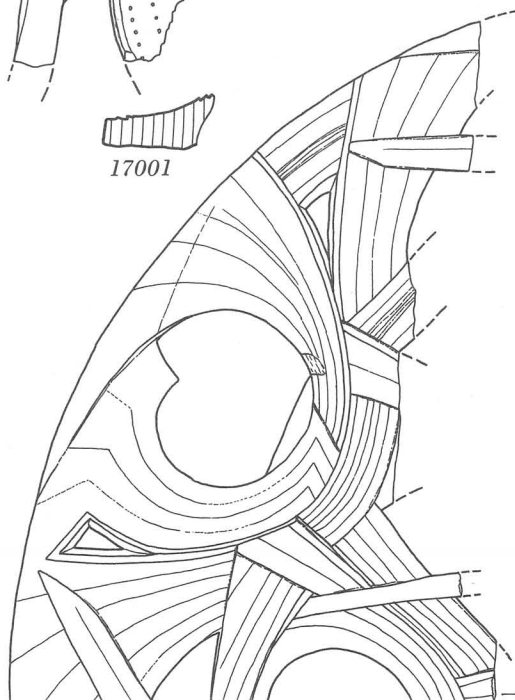

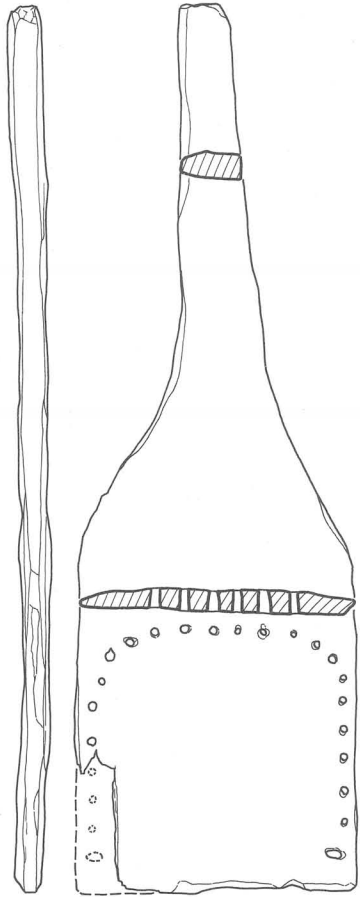

17101

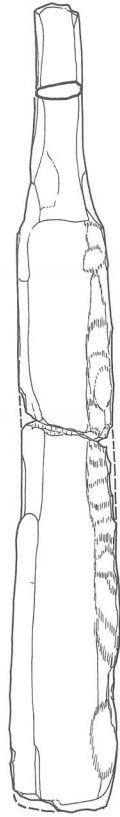

17102



17103

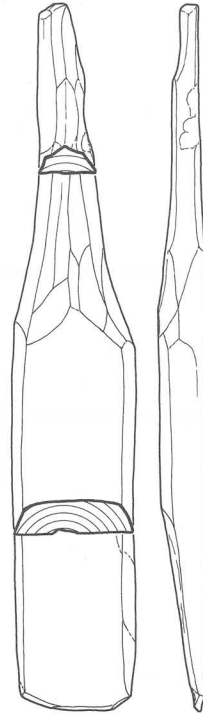

17104

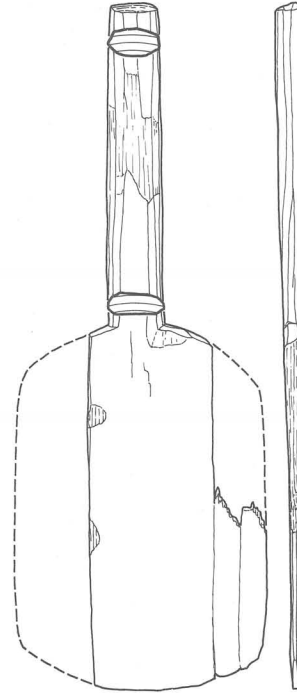

17105



17106

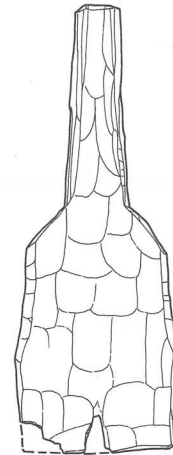
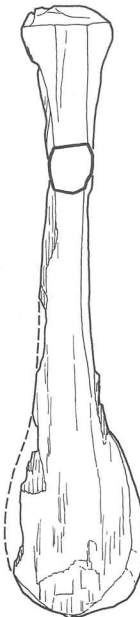

17110



17111

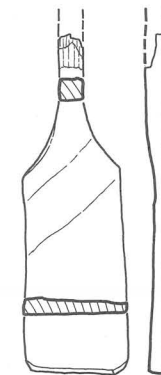

17112

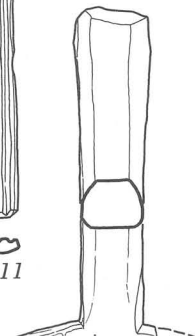
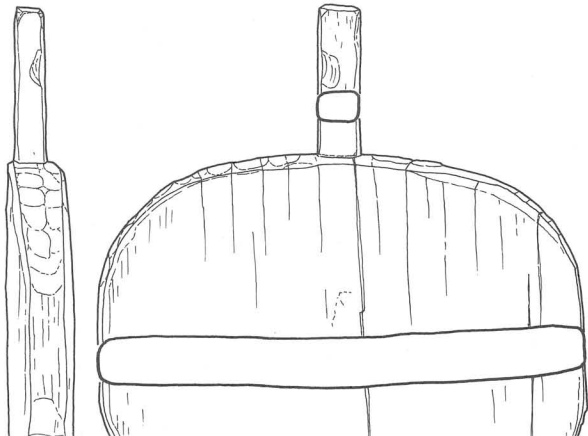

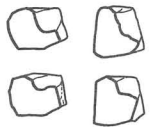
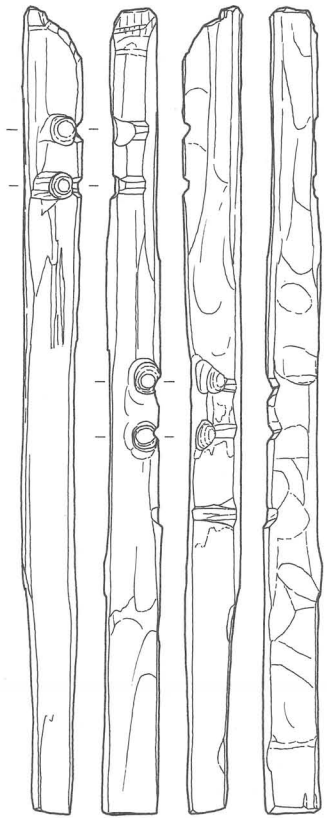

17201

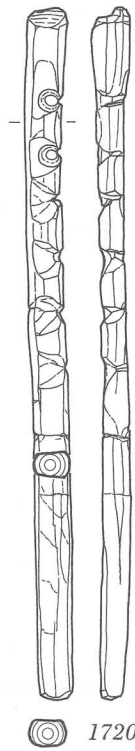

17202

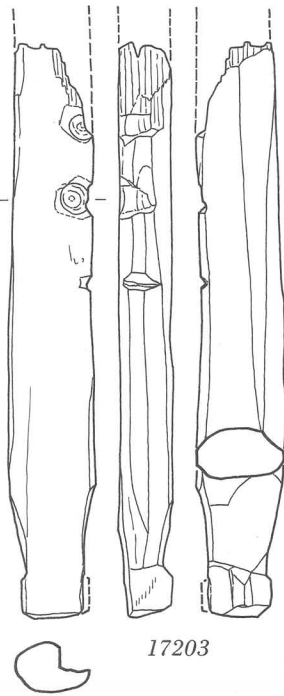

17203



17204



17205

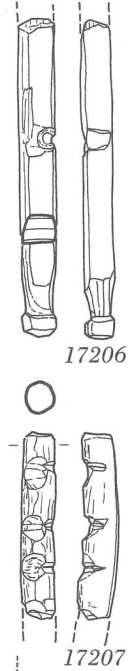

17206

17207



17208

17209

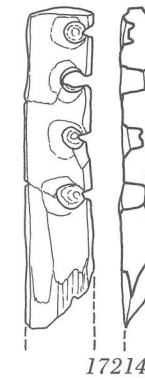

17214

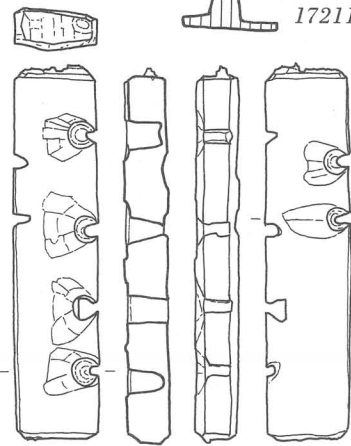
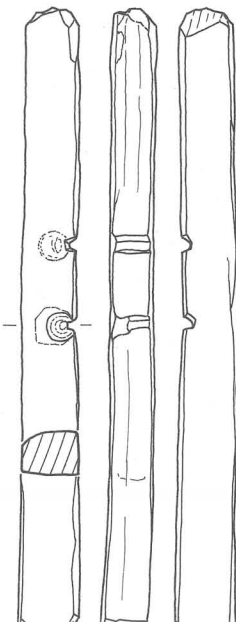

17211

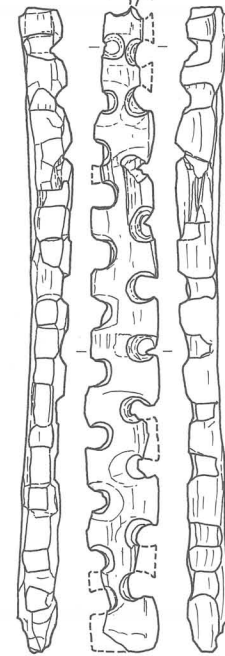

17213

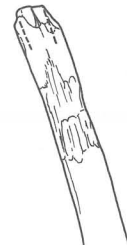

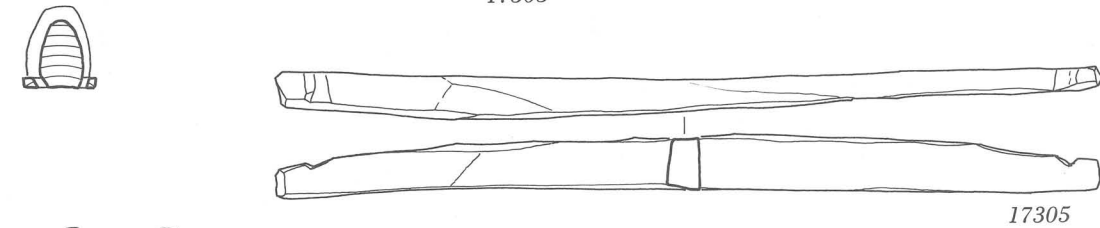
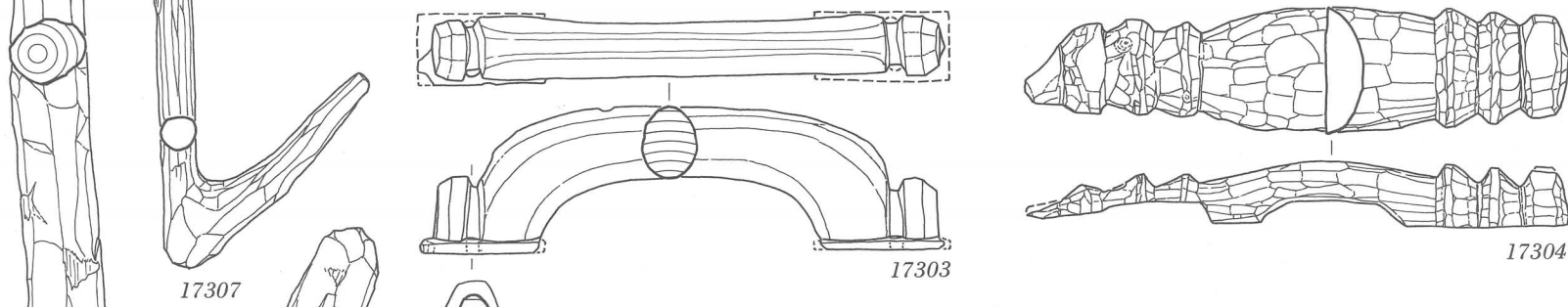
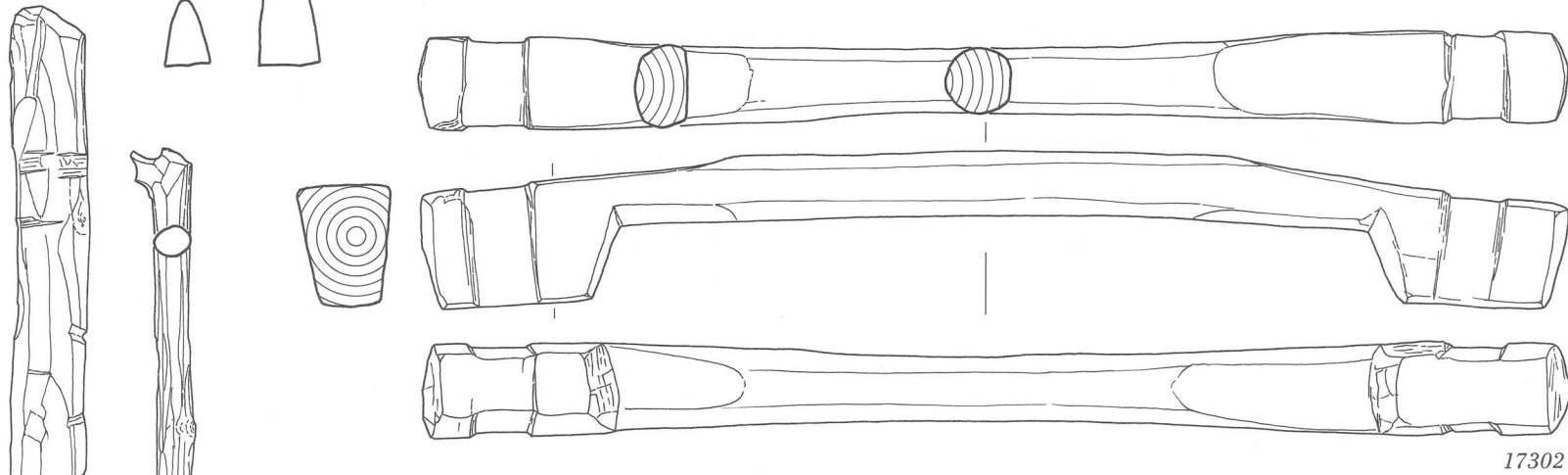
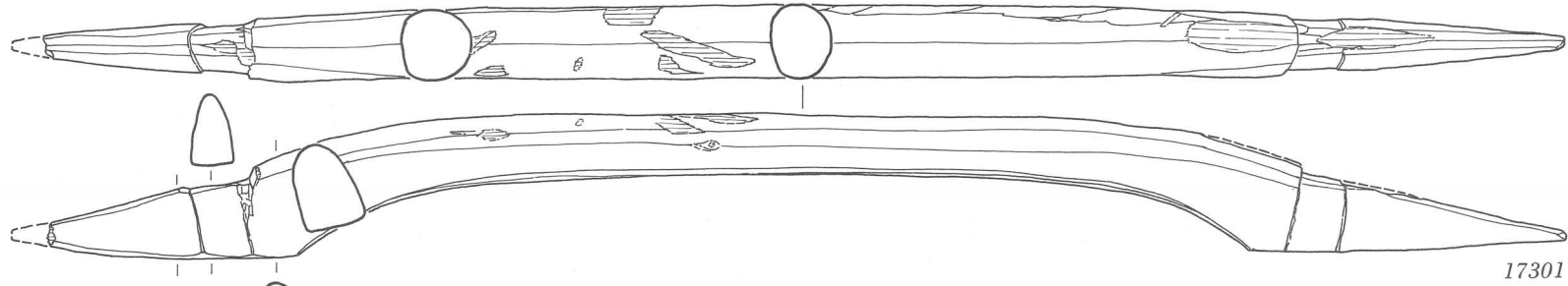

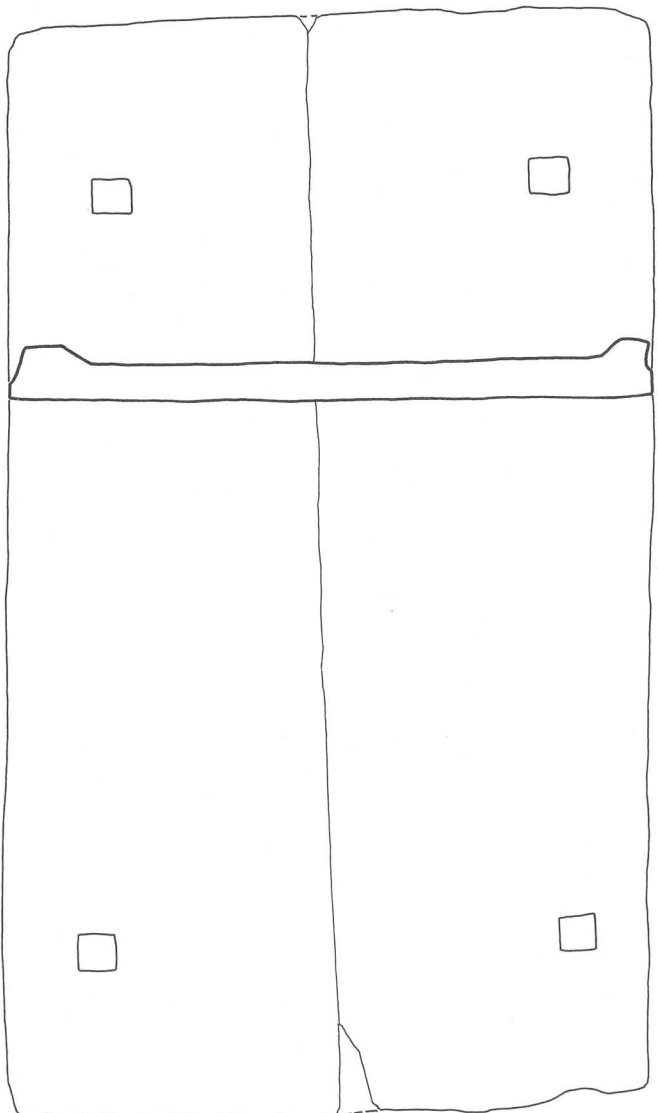
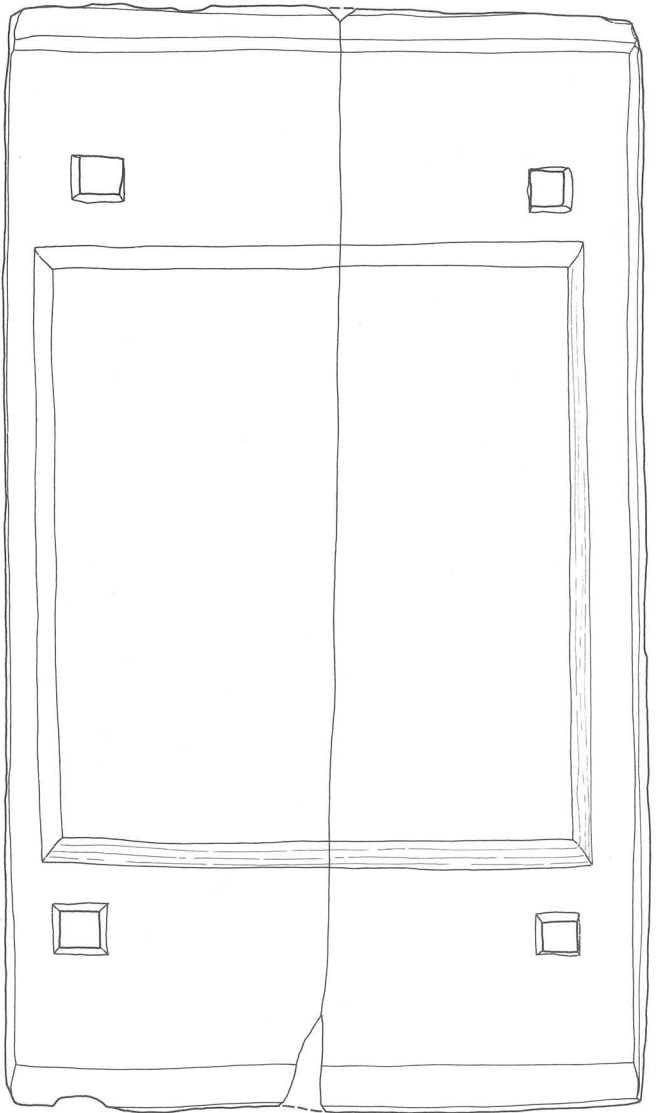
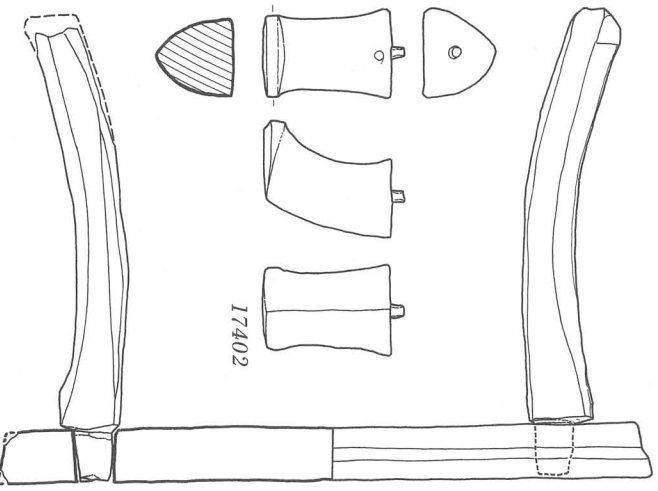
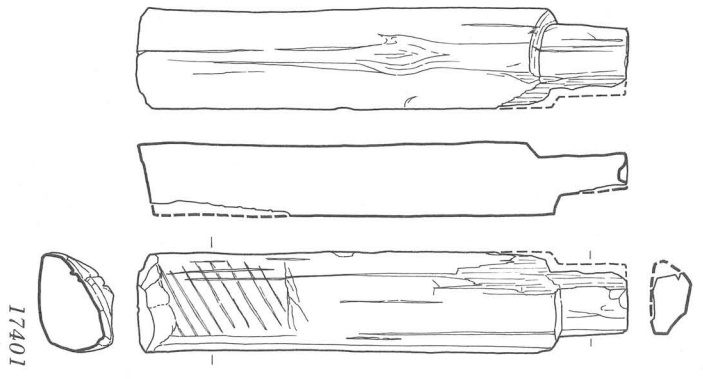

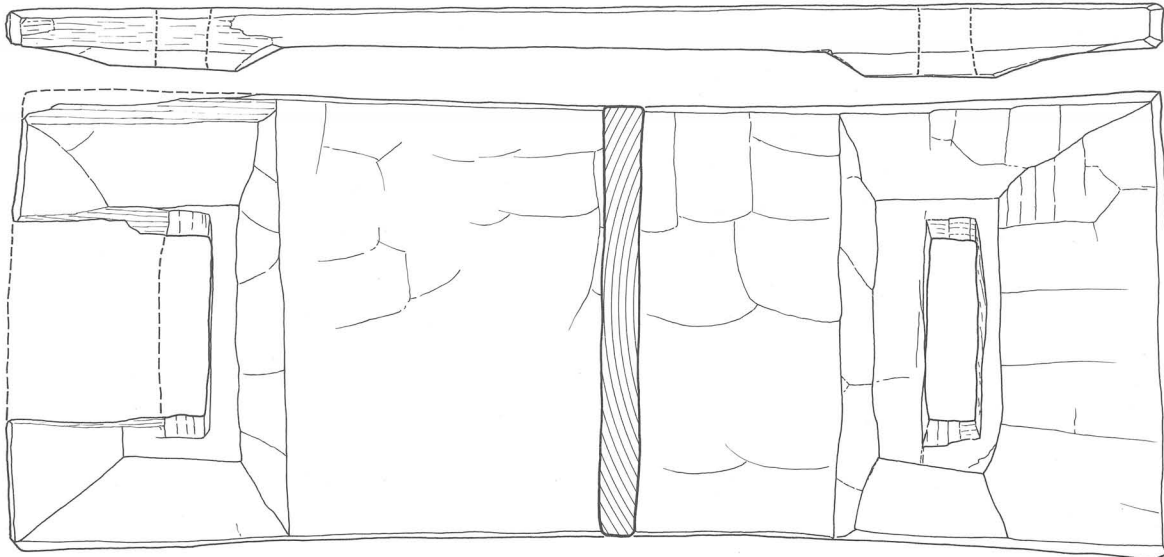

17501

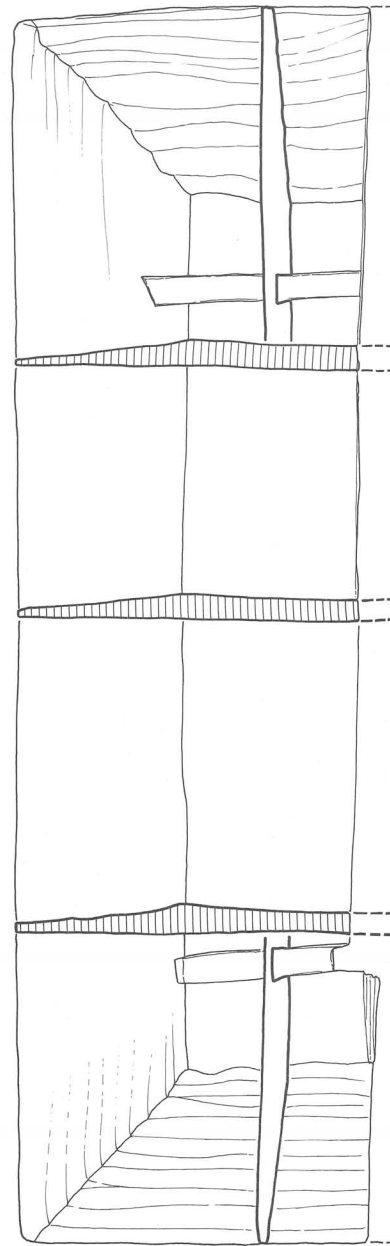

17503

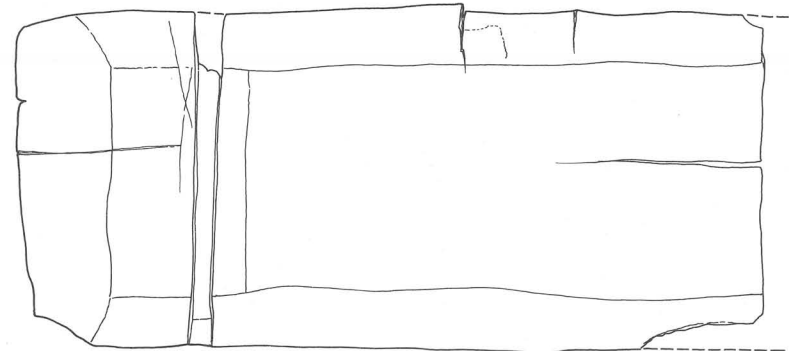
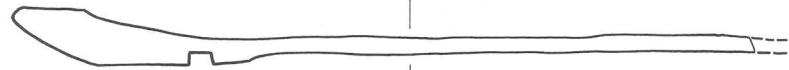
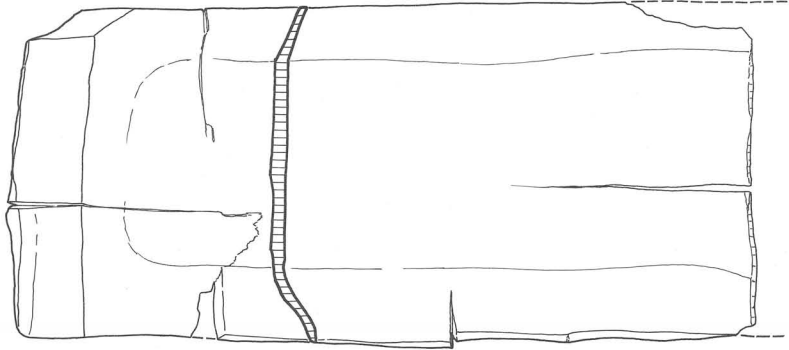

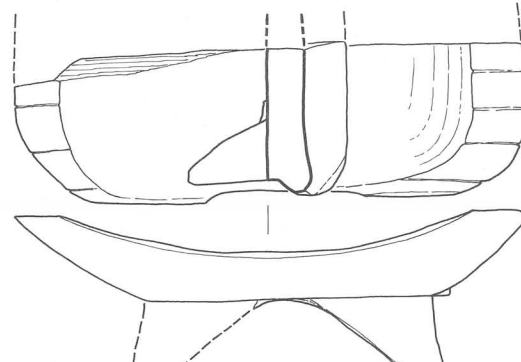
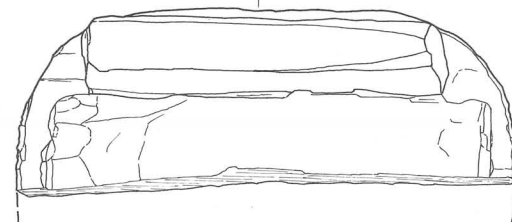
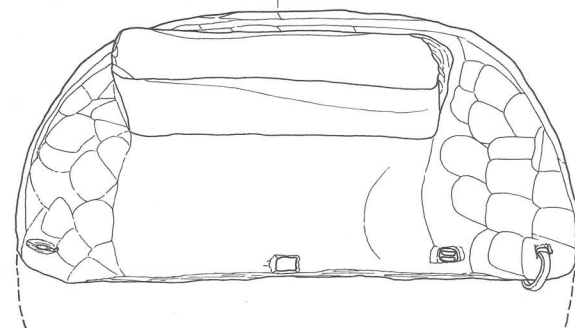
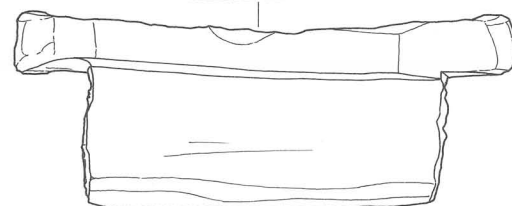
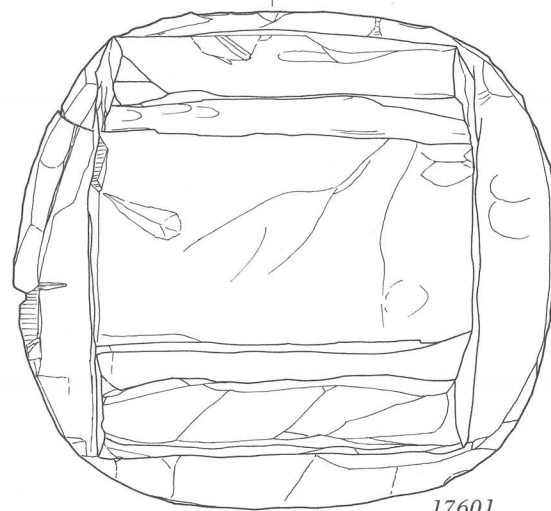
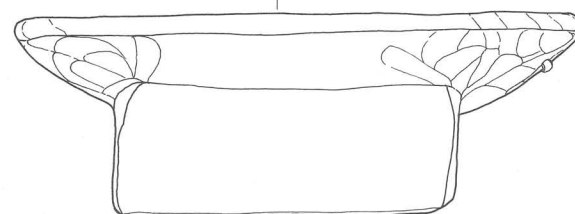
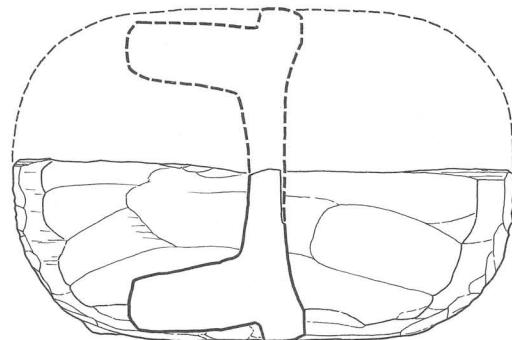
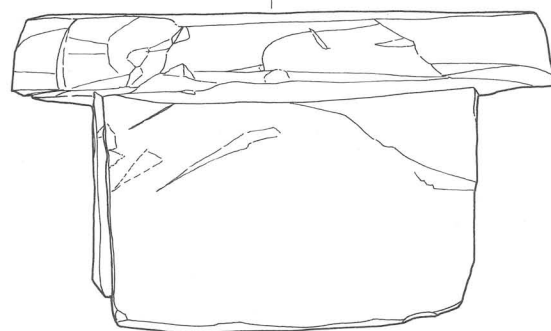
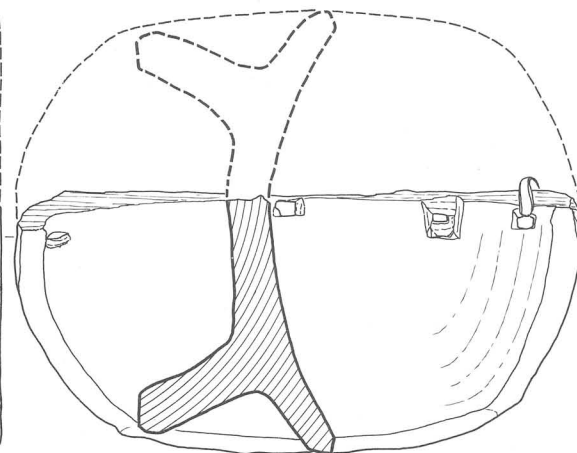
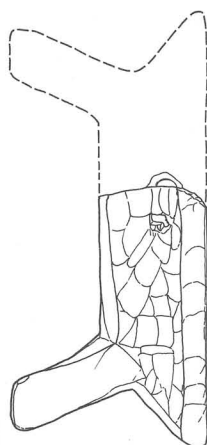
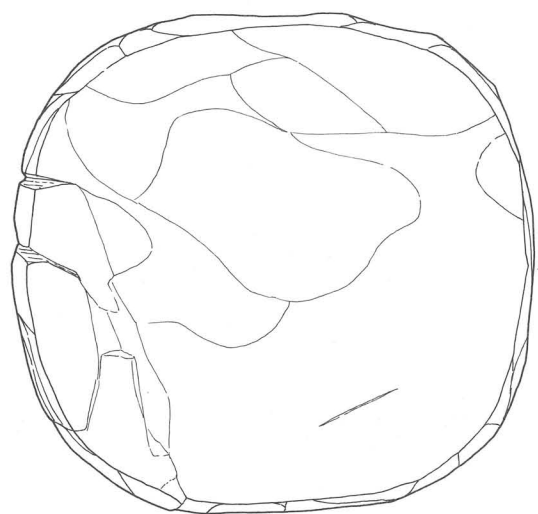

17601

17602

17603

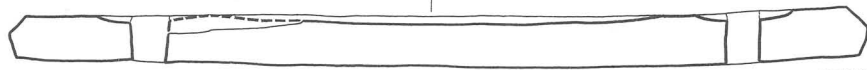
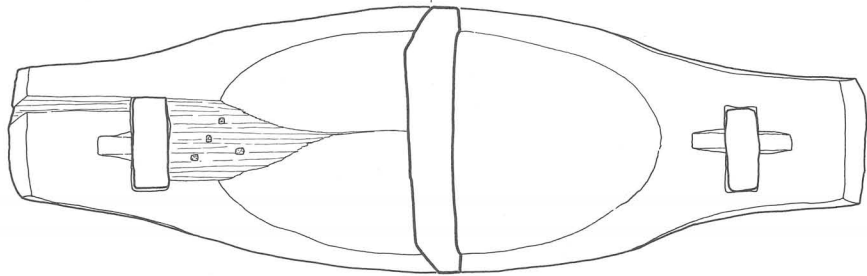
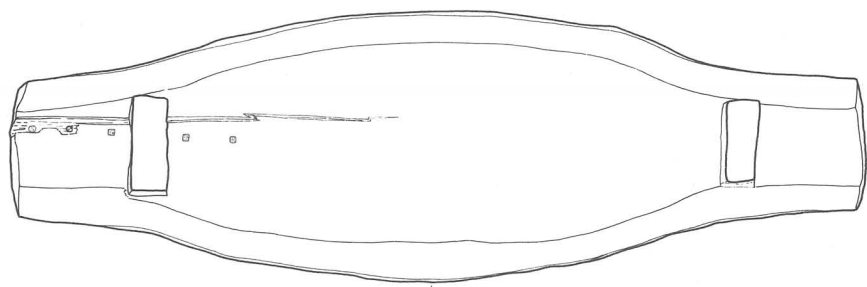

17701

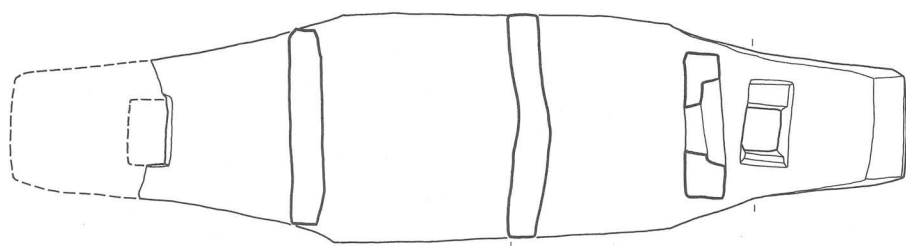

17702

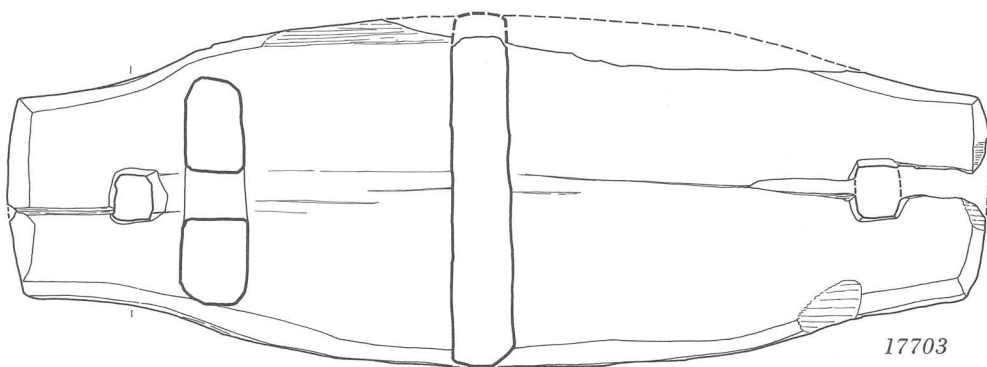

17703

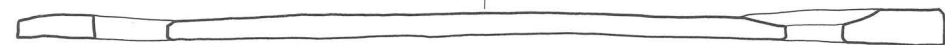
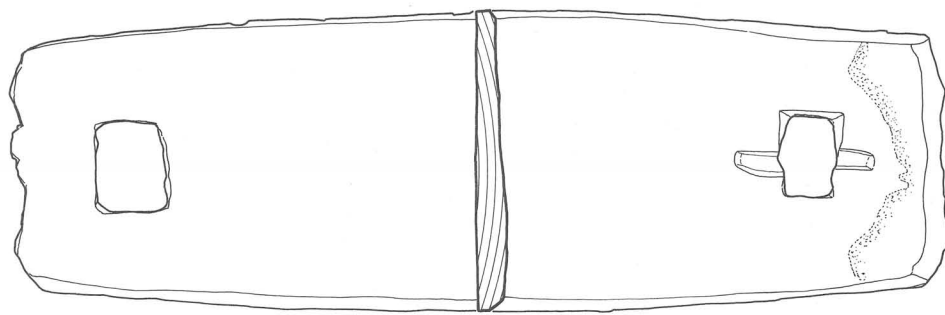

17704

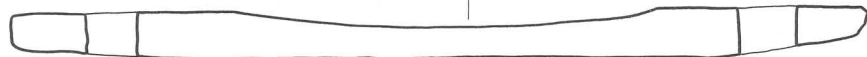
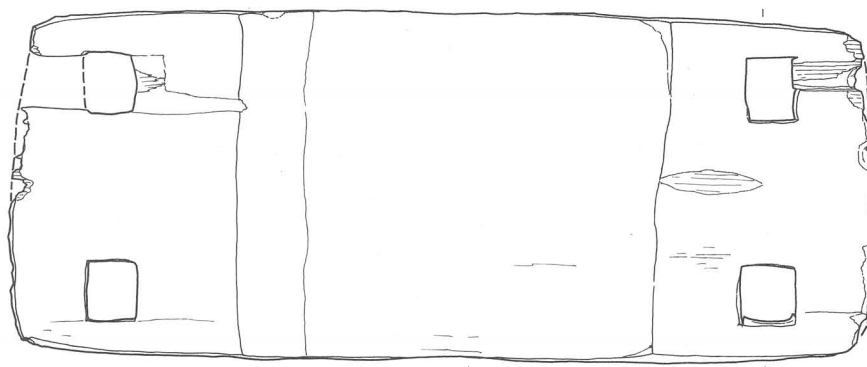

17705

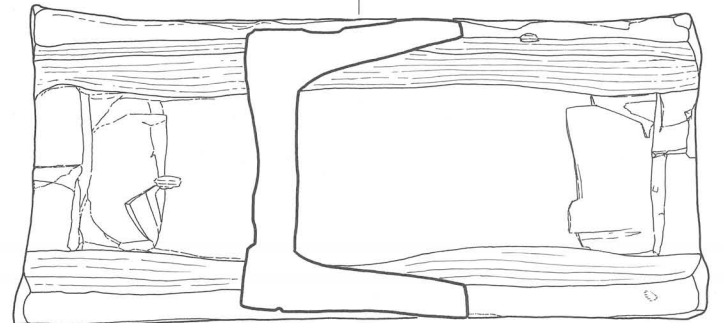
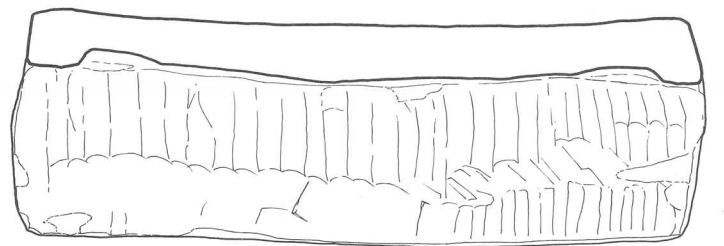

17706

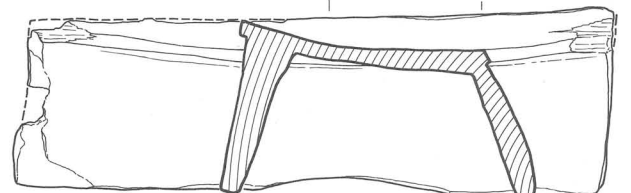
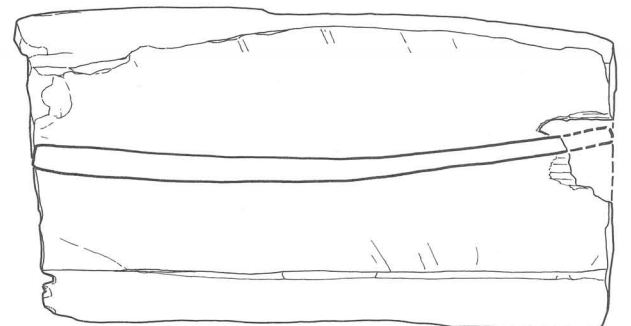

17707

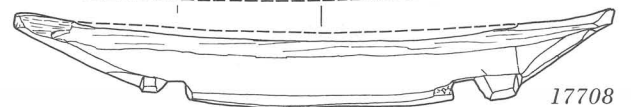
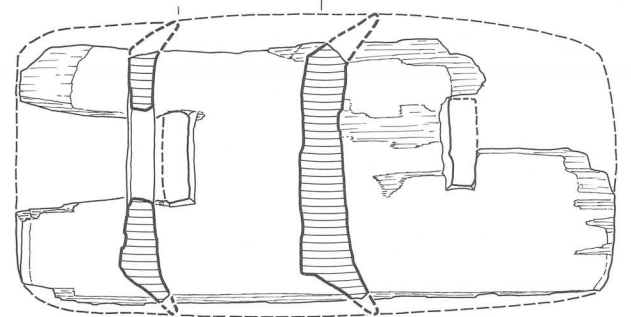
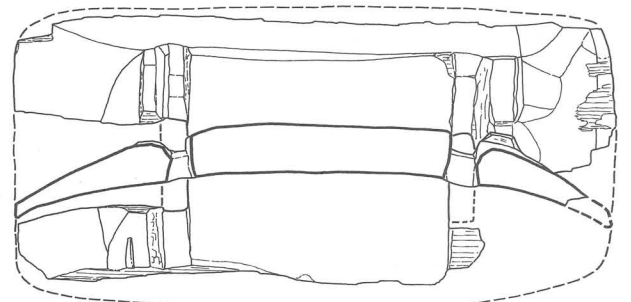

17708

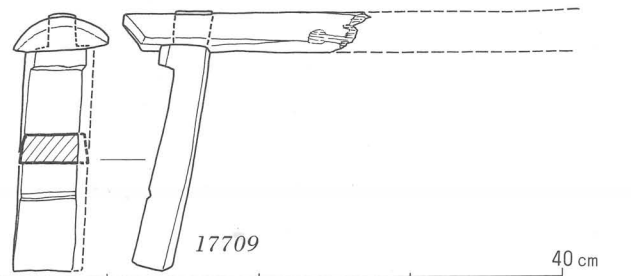

17709

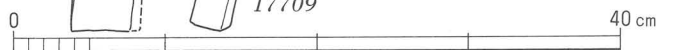

17701 ; 和歌山県鳴神II, 17702 ; 兵庫県播磨長越, 17703 ; 大阪府新家, 17704 ; 三重県北堀池, 17705 ; 奈良県平城京下層, 17706 ; 大阪府瓜生堂, 17707 ; 大阪府鬼虎川, 17708 ; 京都府古殿, 17709 ; 奈良県布留



17801・17805；京都府古殿， 17802・17807・17810～17812；奈良県平城宮下層， 17803；大阪府久宝寺北， 17804；滋賀県入江内湖(行司町地区)， 17806；大阪府亀井， 17808；大阪府瓜生堂， 17809；奈良県十六面・薬王寺

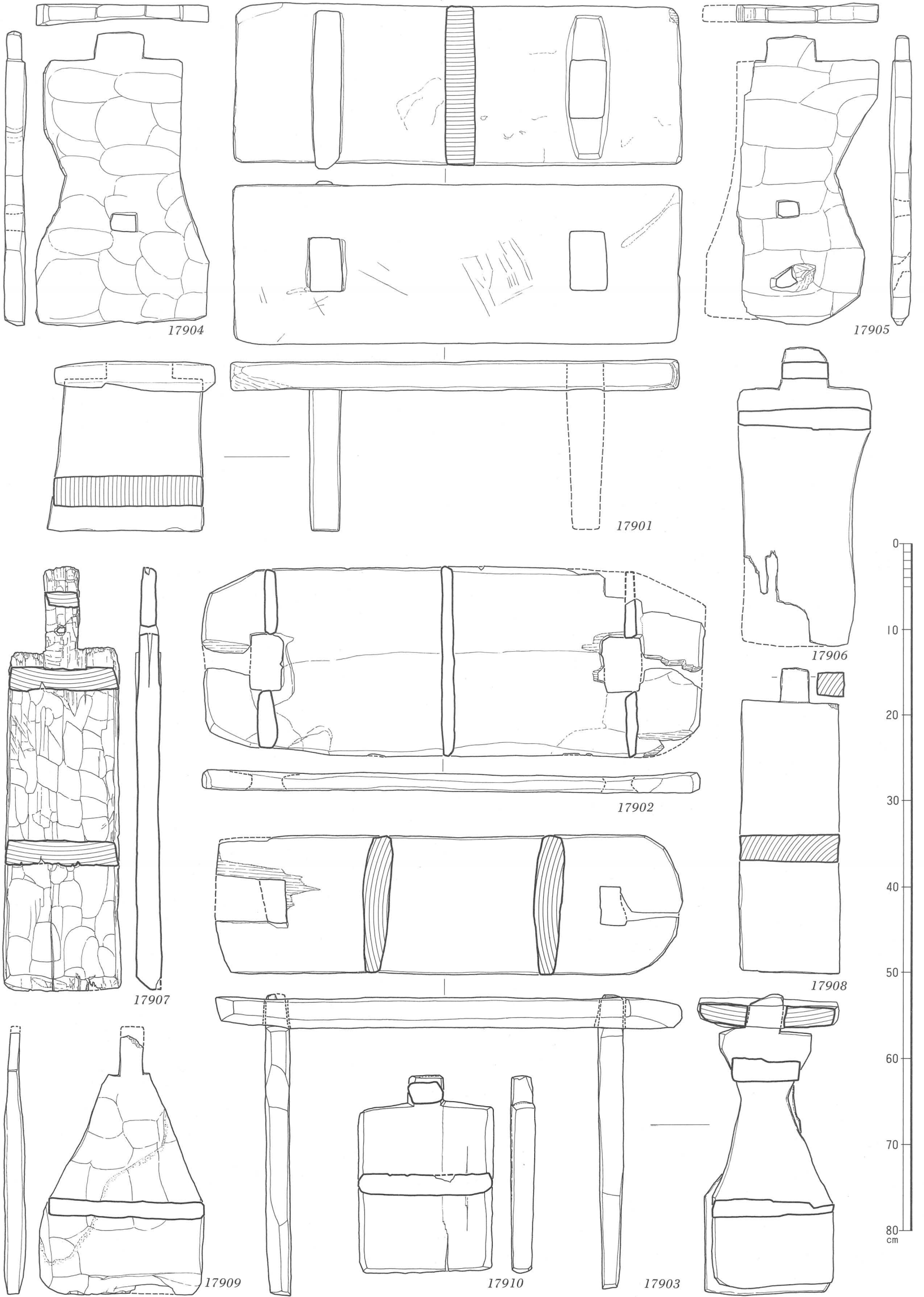

17901；滋賀県正源寺， 17902・17909・17910；兵庫県播磨長越， 17903；兵庫県広井， 17904・17905；兵庫県筒江片引，
17906；兵庫県八反長， 17907；大阪府若江北， 17908；大阪府豊中

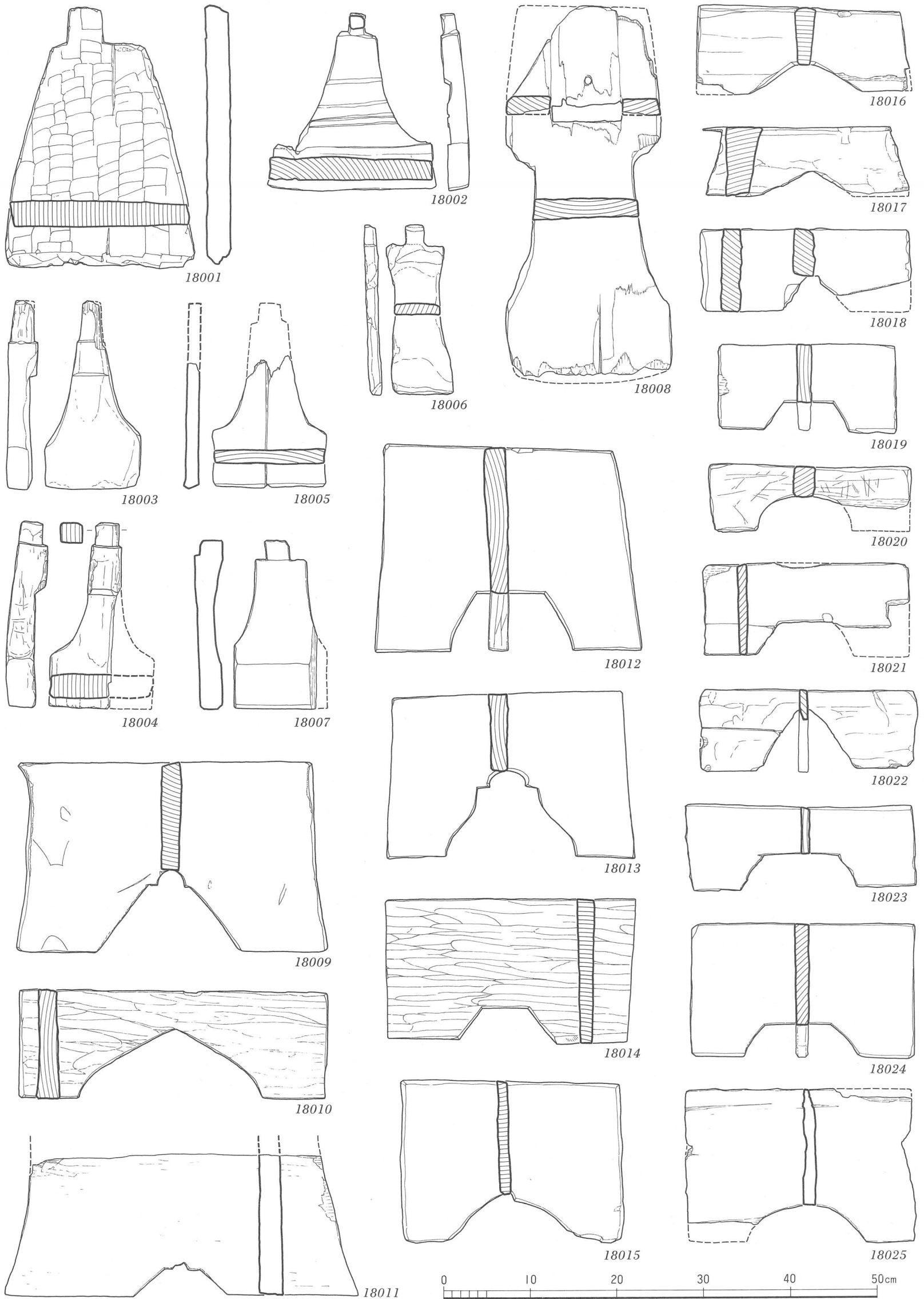

0 10 20 30 40 50cm

18001；大阪府西岩田，18002・18005・18008・18012・18019・18021・18024；奈良県平城京下層，18003・18014；奈良県和爾・森本，18004・18010；滋賀県国友，18006；大阪府巨摩，18007・18015；滋賀県入江内湖(丸葎地区)，18009；滋賀県下線子，18011；大阪府豊中，18013・18018；兵庫県播磨長越，18016・18017・18023；奈良県平城宮下層，18020；大阪府恩智，18022；奈良県平城京朱雀大路下層，18025；京都府岡崎