

6282 E

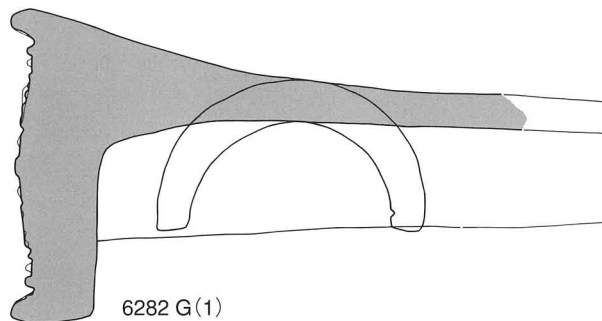

6282 G(1)

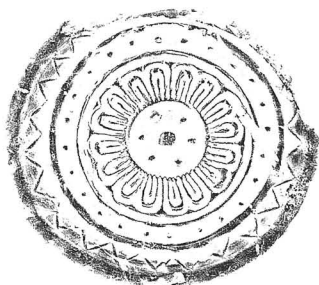
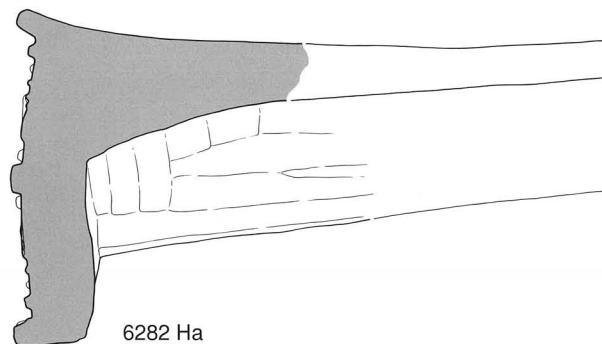
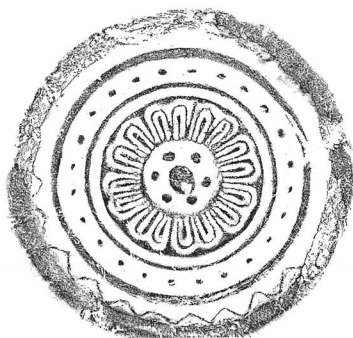

6282 Ha

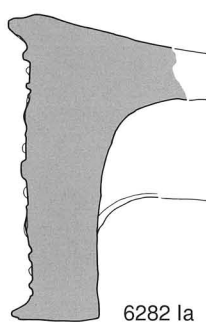
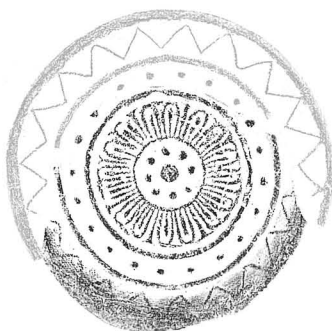

6282 la

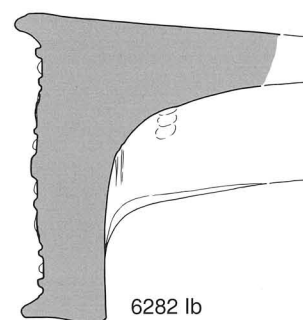
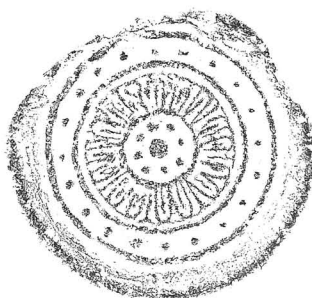

6282 lb



型式・種	直径	内区					外区		外縁				全長	玉縁長	点数
		中房径	蓮子数	弁区径	弁数	間弁	幅	文様	幅	高さ	文様	形態			
6282 E	166	27	1+6	82	F 8	B	18	S 24	24	14	LV 24	傾斜縁 I	401	37	20
G	165	43	1+6	94	F 8	B	13	S 24	24	15	LV 25	傾斜縁 I			14
Ha	177	42	1+6	102	F 8	B	17	S 24	23	12	LV 25	傾斜縁 I			5
la	157	39	1+8	91	F 8	B	16	S 20	19	14	LV 20	傾斜縁 III			15
lb	158	38	1+8	90	F 8	B	15	S 20	18	14	LV 20	傾斜縁 III			5



6282 I a
瓦当裏面



6282 I a



6282E



6282E
瓦当裏面



6282G (1)
瓦当裏面 (接合線台形)



6282G (1)



6282G (2)
瓦当裏面 (接合線半円形)



6282Ha



6282Ha
瓦当裏面



6282 I b
瓦当裏面



6282 I b

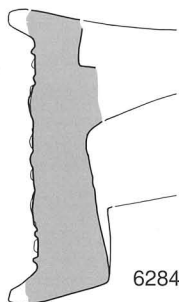
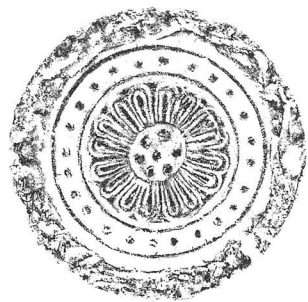

6284 A

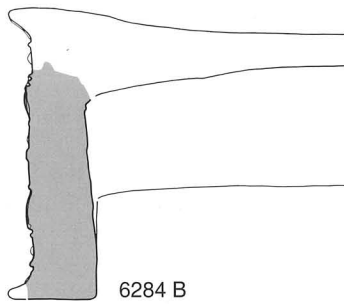
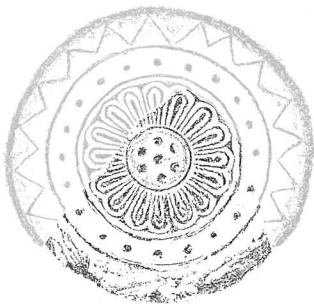

6284 B

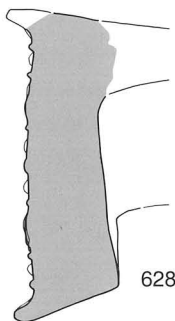
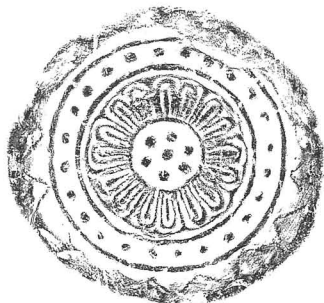

6284 C

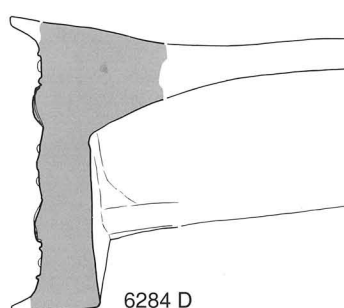
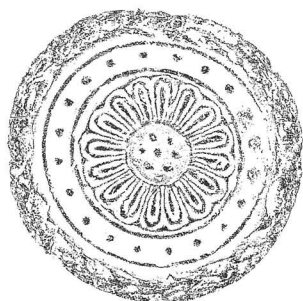

6284 D

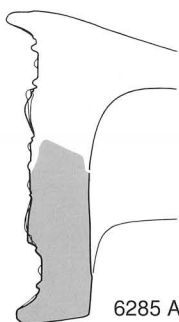
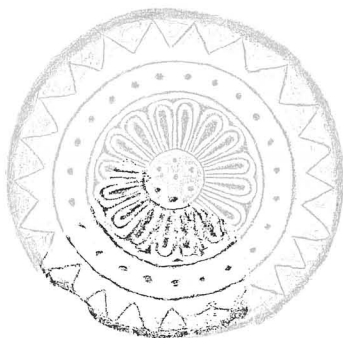

6285 A

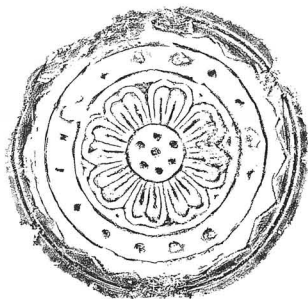

6291 A

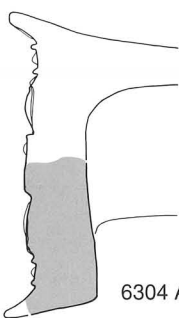
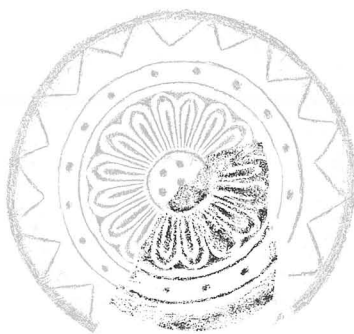

6304 A

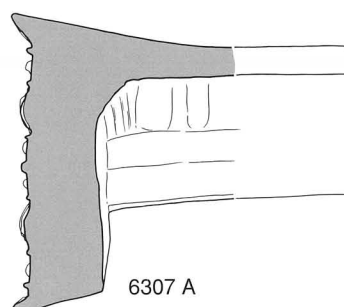
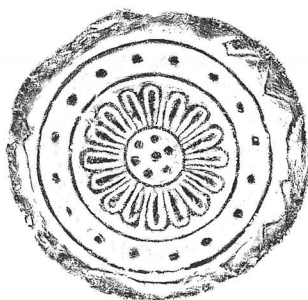

6307 A



型式・種	直径	内		区			外区		外縁				全長	玉縁長	点数
		中房径	蓮子数	弁区径	弁数	間弁	幅	文様	幅	高さ	文様	形態			
6284 A	154	32	1+6	87	F 8	B	15	S 24	23	13	LV 23	傾斜縁Ⅱ			2
B		35	1+6	88	F 8	B	15	S 20	19	13	LV 20	傾斜縁Ⅱ			4
C	163	39	1+6	93	F 8	B	12	S 24	20	13	LV 16	傾斜縁Ⅱ			10
D	158	36	1+6	92	F 8	B	16	S 20	21	14	LV 16	傾斜縁Ⅱ			1
6285 A		31	1+6	89	F 8	B	17	S 23	19	15	LV 22	傾斜縁Ⅱ			4
6291 Ab	158	29	1+6	85	F 8	B	14	S 16	21	6	LV 16	傾斜縁Ⅲ			1
6304 A		31	1+6	104	F 8	B	12	S 17	20	16	LV 16	傾斜縁Ⅱ			1
6307 A	155	32	1+6	89	F 8	なし	17	S 16	17	11	LV 16	傾斜縁Ⅱ			2



6285A



6284A



6284C



6304A



6284B



6284D



SG8500A池底 軒瓦出土状況
(第276次 第1トレンチ 西からみる)



6291Ab



6307A

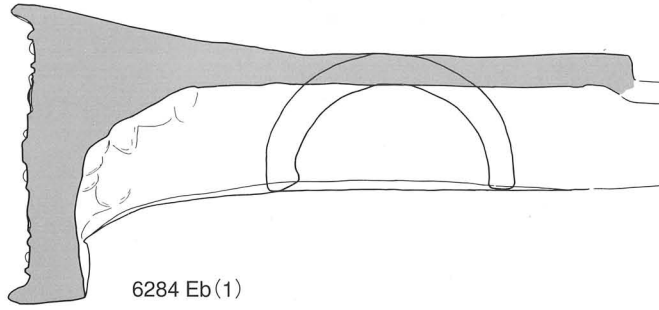
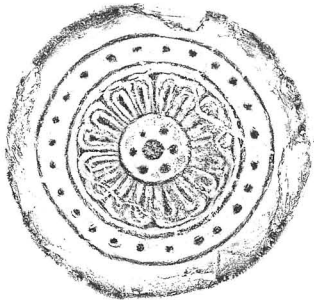

6284 Eb(1)

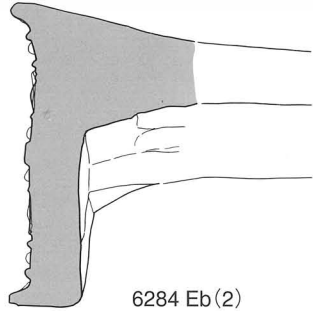

6284 Eb(2)

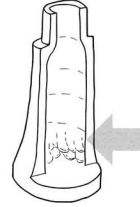
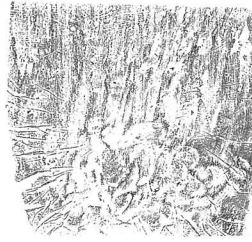

6284 Eb(1) 丸瓦部凹面から接合部にかけてのこる指頭ないし先端円形工具の圧痕(1:5)

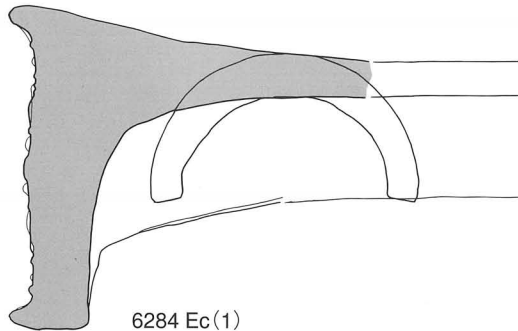
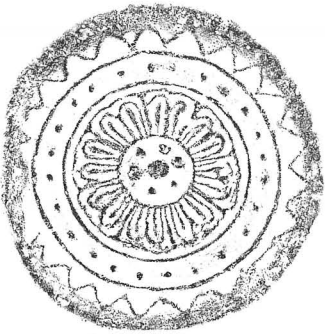

6284 Ec(1)

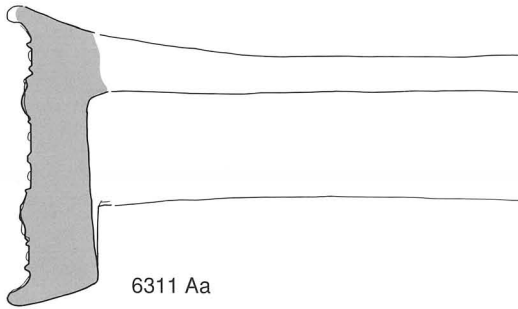
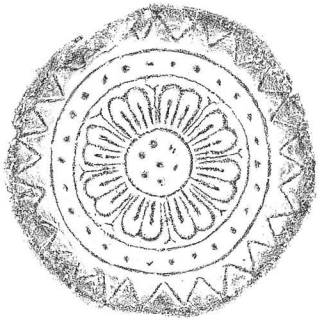

6311 Aa

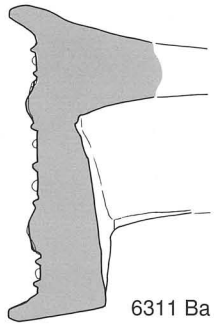
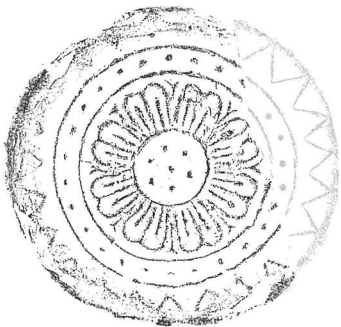

6311 Ba

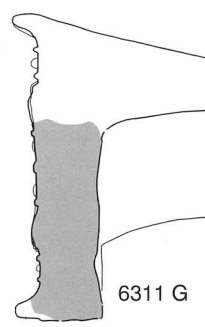

6311 G



型式・種	直径	内		区			外区		外縁				全長	玉縁長	点数
		中房径	蓮子数	弁区径	弁数	間弁	幅	文様	幅	高さ	文様	形態			
6284 Eb	164	39	1+6	95	F 8	B	15	S24	17	12	LV 22	傾斜縁Ⅱ			18
Ec	165	39	1+6	96	F 8	B	15	S24	20	13	LV 22	傾斜縁Ⅰ			5
6311 Aa	155	38	1+6	97	F 8	A	16	S26	20	12	LV 23	傾斜縁Ⅱ			5
Ba	162	38	1+6	93	F 8	A	11	S26	21	17	LV 26	傾斜縁Ⅱ			7
G		37	1+6	98	F 8	A	13	S20	21	16	LV 16	傾斜縁Ⅱ			1



6284Ec (1)



6284Eb (1)



6284Ec (1)
瓦当裏面



6284Eb (2)
瓦当裏面



6284Ec (2)
瓦当裏面



6284Eb (3)
瓦当裏面



6311G



6311Aa



6284Eb (1)
丸瓦部凹面
から瓦当裏面



6311Ba

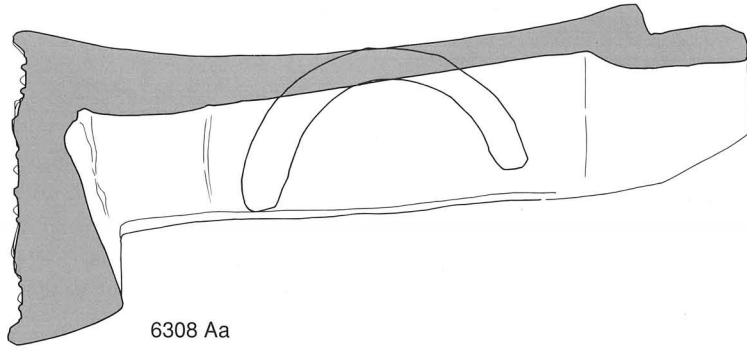
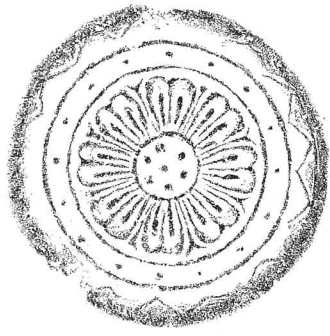

6308 Aa

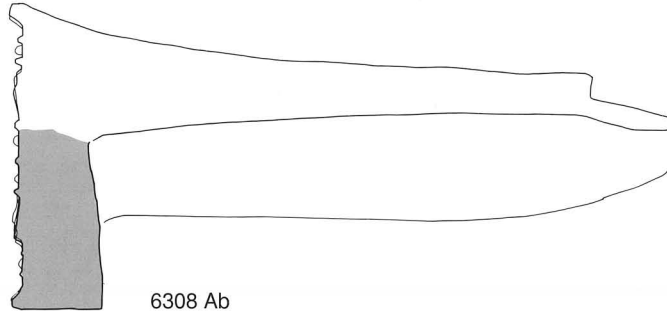
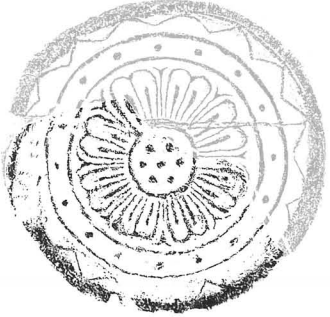

6308 Ab

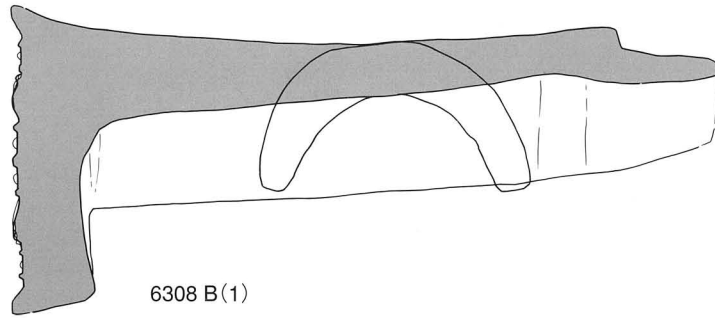
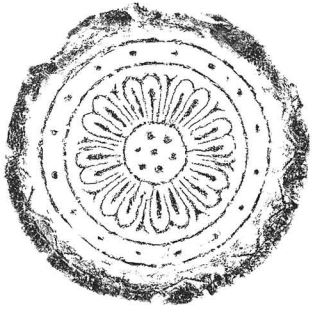

6308 B(1)

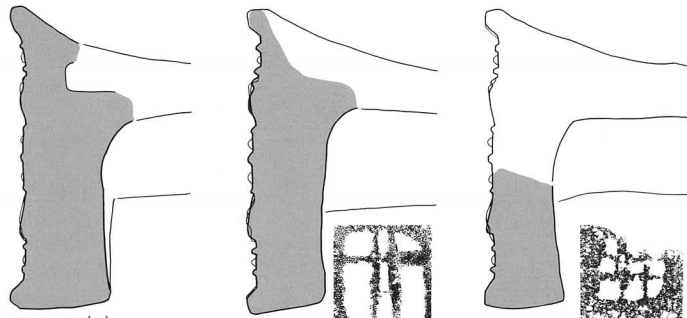
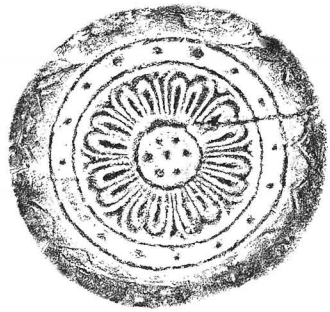

6308 B(2)

6308 B(3)
刻印「北」(1:1)



6308 B(4)
刻印「井(C)」(1:1)

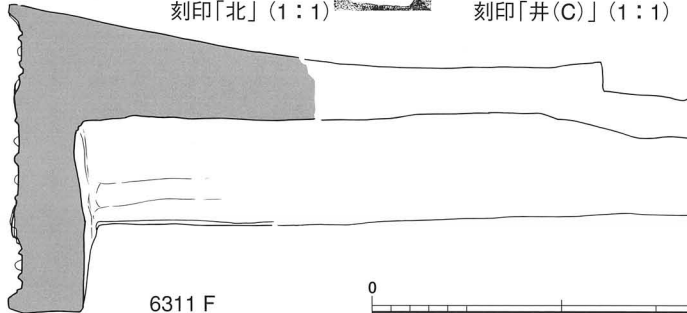
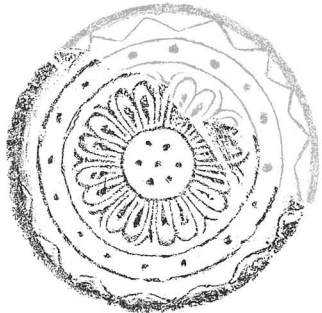

6311 F



型式・種	直径	内区					外区		外縁				全長	玉縁長	点数
		中房径	蓮子数	弁区径	弁数	間弁	幅	文様	幅	高さ	文様	形態			
6308 Aa	167	32	1+6	97	F 8	A	12	S 16	20	6	LV 16	傾斜縁Ⅱ	387	55	16
Ab	157	38	1+6	102	F 8	A	14	S 16	18	6	LV 16	傾斜縁Ⅱ			3
B	160	34	1+6	94	F 8	A	12	S 16	21	5	LV	傾斜縁Ⅰ	369	54	53
6311 F	162	38	1+6	99	F 8	A	11	S 16	19	9	LV 16	三角縁			3



6308Aa



6308B (1)



6308Aa
瓦当裏面



6308B (2)
瓦当裏面



6311F
瓦当裏面



6308Ab



6308B (4)



6308B (3)



6308B (4)
瓦当側面



刻印「井(C)」(1:1)



6308B (3)
瓦当裏面



刻印「北」(1:1)

瓦当面1:3

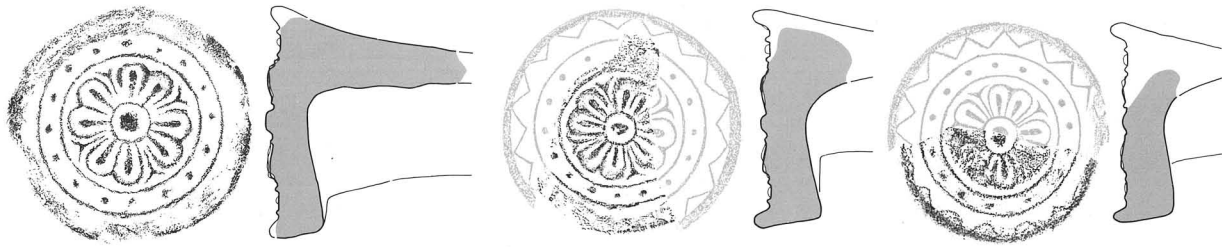

6313 Aa

6313 B

6313 E

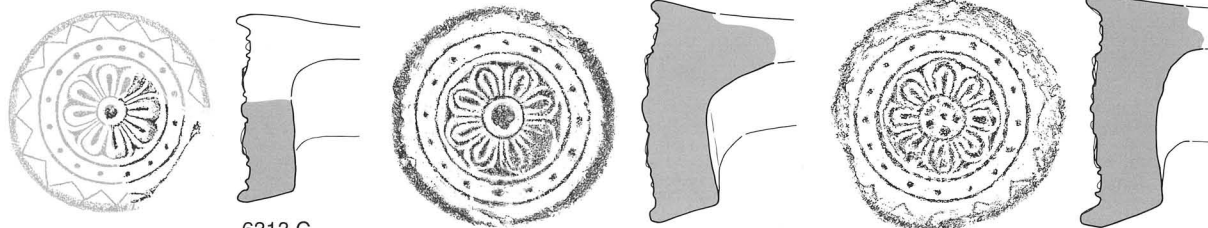

6313 C

6313 H

6314 Ca

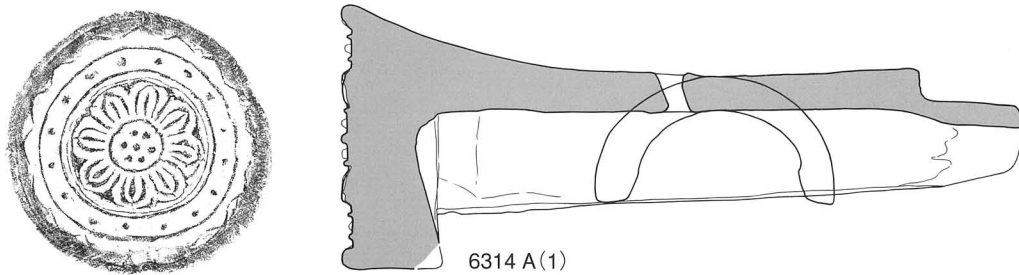

6314 A(1)

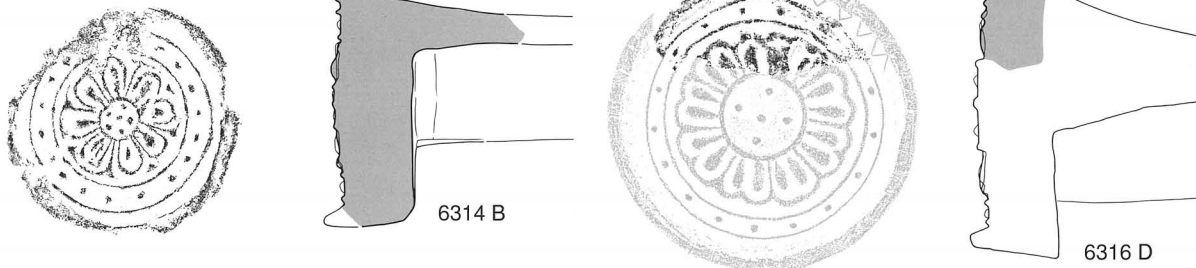

6314 B

6316 D

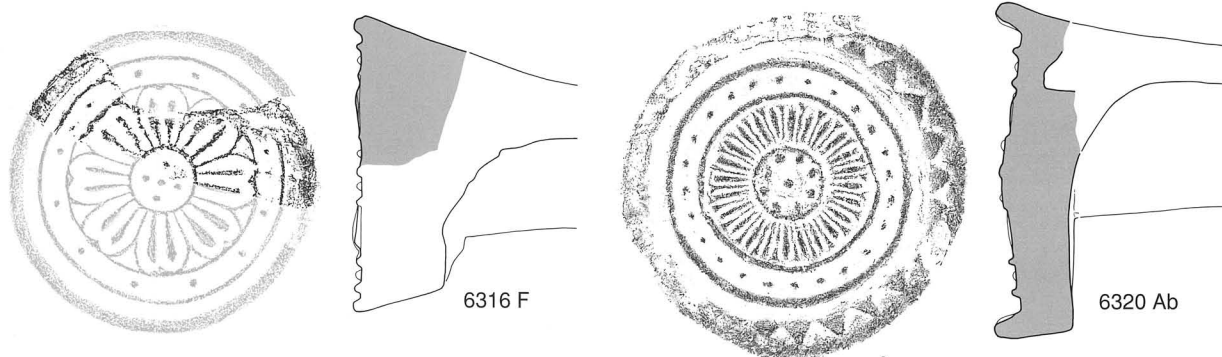

6316 F

6320 Ab



型式・種	直径	内 区					外 区		外 縁				全長	玉縁長	点数
		中房径	蓮子数	弁区径	弁数	間弁	幅	文様	幅	高さ	文様	形態			
6313 Aa	123	19	1	67	F 4	A	11	S 16	13	7	LV 16	傾斜縁 II	364	52	4
B		18	1	68	F 4	A	10	S 16	15	9	LV 16	傾斜縁 II			1
C		15	1	57	F 4	A	9	S 16	12	8	LV 16	傾斜縁 II			2
E	106	16	1	66	F 4	A	10	S 16	15	9	LV 16	傾斜縁 II			1
H	120	23	1	69	F 4	B	11	S 16	14	5	LV	傾斜縁 I			1
6314 A	134	28	1+6	78	F 4	B	12	S 16	17	5	LV 16	傾斜縁 III			61
B	123	21	1+5	70	F 4	B	12	S 19	16	11	LV	傾斜縁 II	3		
Ca	121	26	1+5	66	F 4	B	12	S 16	14	13	LV 16	傾斜縁 II	3		
6316 D		44	1+	105	F 9	なし	12	S 17	8	9	LV	直立縁 I	1		
F		35	1+4	99	F 8	なし	14	S 12	-	-	-	直立縁 I	2		
6320 Ab	173	38	1+8	93	T 24	なし	17	S 24	23	16	RV 24	傾斜縁 I	1		



6313Aa



6313H



6314A (1)



6313B



6314B



6316D



6313C



6313E



6316F



6314A (2)
瓦当裏面



6314Ca



6320Ab



6314A (1)
丸瓦部凸面穿孔

瓦当面1:3

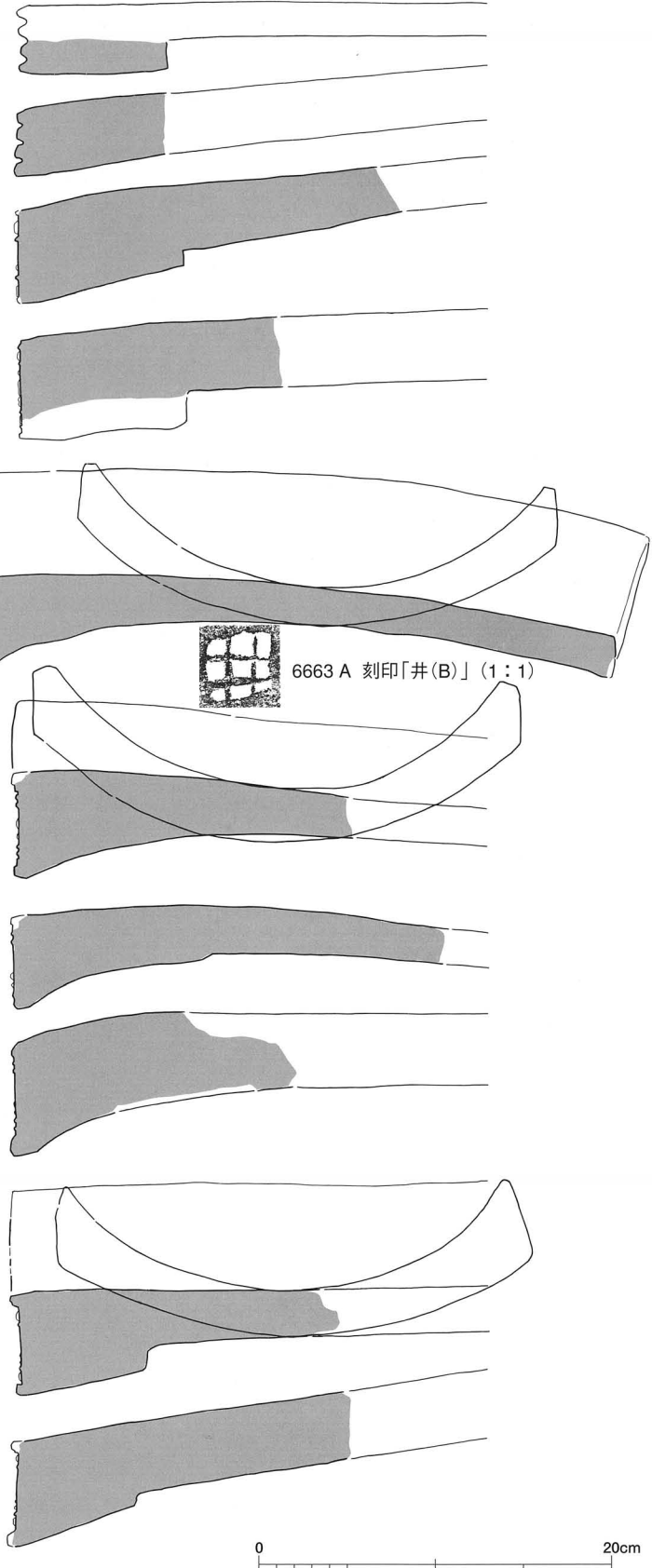
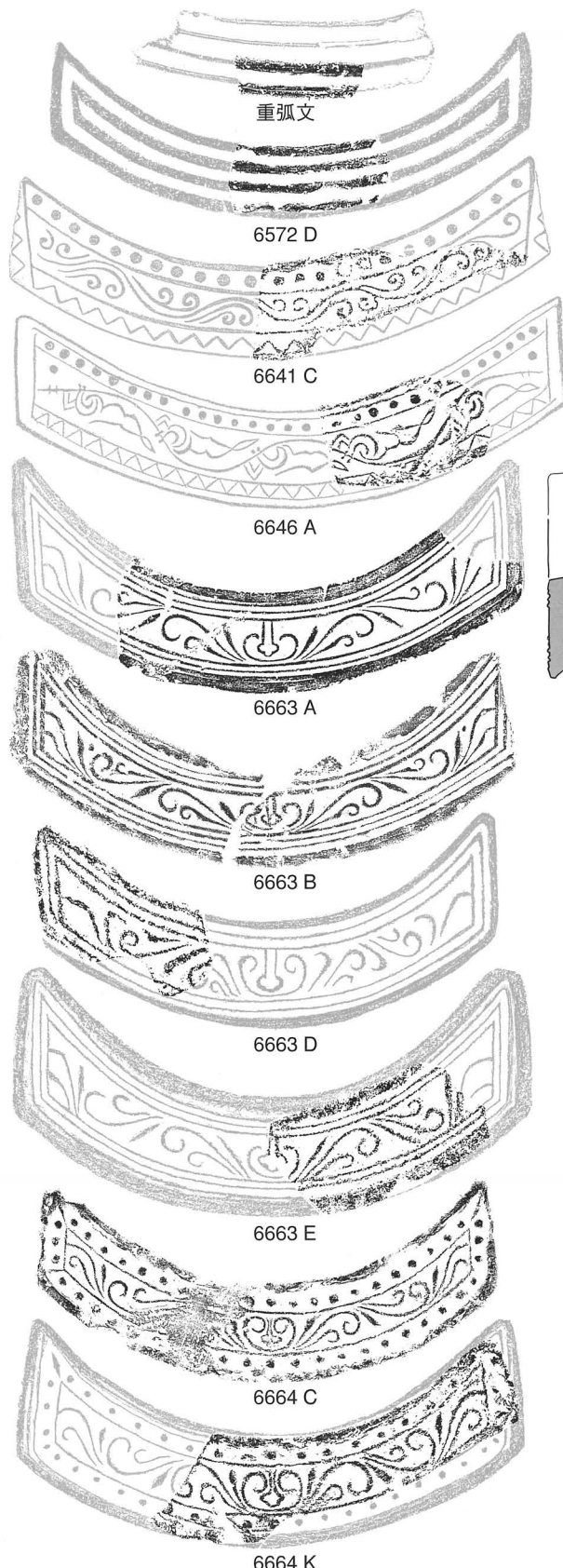

型式・種	最大幅	厚さ	内区		上外区		下外区		脇区		全長	頸形態	点数
			厚	文様	厚	文様	厚	文様	幅	文様			
重弧文													
6572 D		41		J								段 I L	1
6641 C		47	22	HK	14	S 23	13	LV 20		LV 5		直	1
6646 A		56	28	HK	15	S 30	14	LV 25	7	-		段 II	1
6663 A	287	41	25	KK	7	K	8	K	7	K	383	段 I L	1
6663 B		29	26	KK	6	K	10	K	6	K		直曲 I	59
6663 D		45	27	KK	8	K	8	K	7	K		曲 I	23
6663 E		45	25	KK	9	K	10	K	8	K		曲 II	2
6664 C		264	43	24	KK	13	S 21	12	S 21	12		S 3	曲 II
6664 K		46	28	KK	6	S 17	10	S 19	10	S 3	段 I L	5	
												段 I L	3



6663D



6664C



6663E



6664K

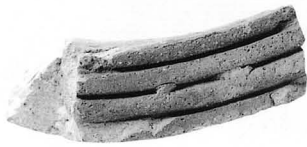

6572D



6663B



重弧文



6663A



6641C



6663A 凸面と刻印「井(B)」(右、1:1)



6646A

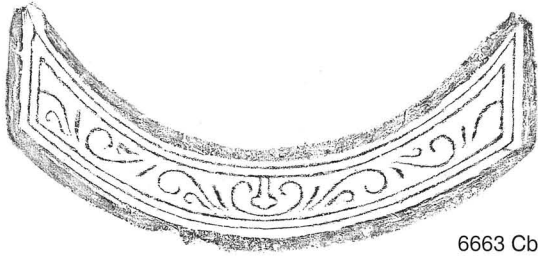

6663 Cb

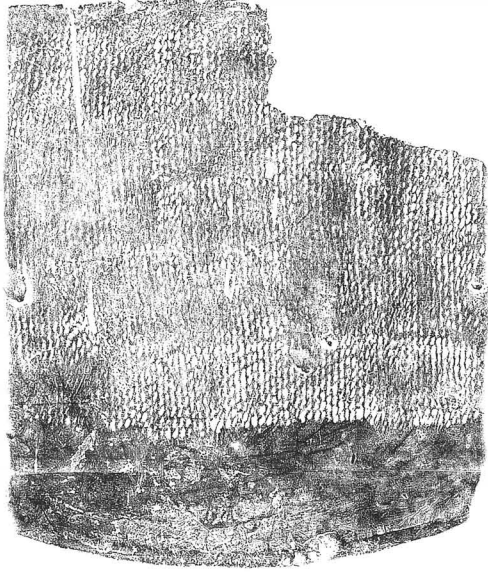
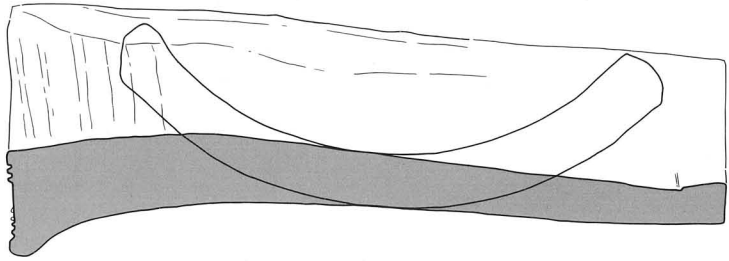

凸型台压痕 ▶

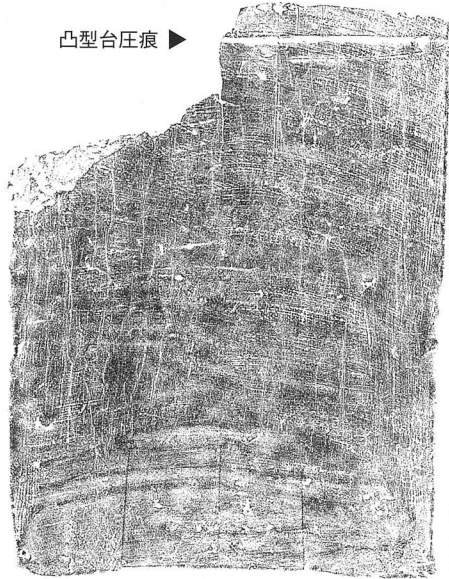

6663 Cb
凸面(左) 凹面(右)
(1:5)



6664 D(1)

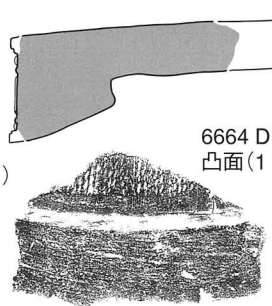

6664 D(2)
凸面(1:5)

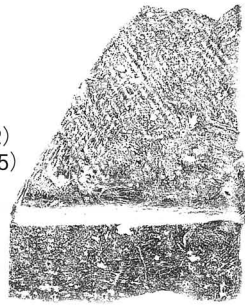

6664 D(3)
凸面(1:5)



6664 M

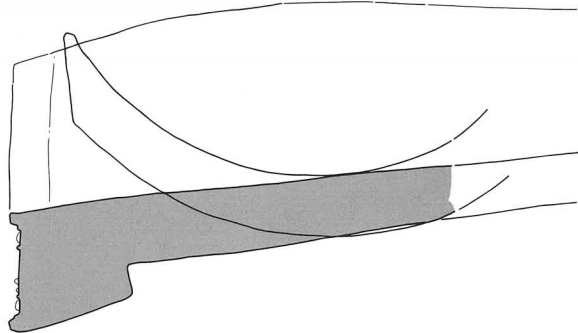

6667 A

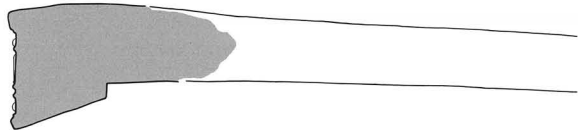

0 20cm

型式・種	最大幅	厚さ	内区		上外区		下外区		脇区		全長	顎形態	点数
			厚	文様	厚	文様	厚	文様	幅	文様			
6663 Cb	276	39	24	KK	7	K	11	K	8	K	374	曲Ⅱ	24
6664 D	277	40	26	KK	10	S 17	9	S 19	12	S 3		段Ⅰ S	16
M		43	26	KK	9	S 23	7	S 23	12	S 3		段Ⅰ L	1
6667 A		45	25	KK	9	S 21	11	S 21	10	S 3		段Ⅰ L	5



6667A



6664D (1)

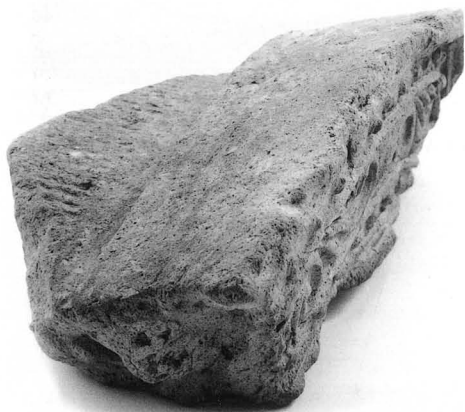

6664D (2) 凸面



6664M



6664D (3) 凸面



6663Cb



6663Cb
狭端付近
凸型台压痕

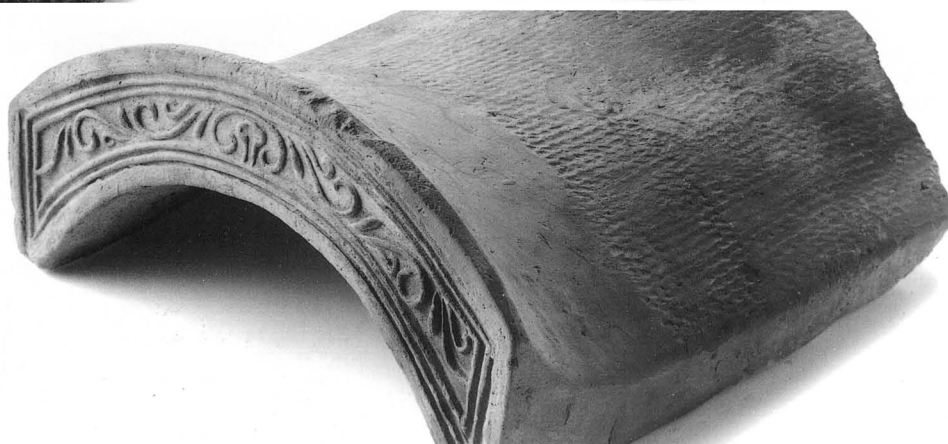

6663Cb 凸面

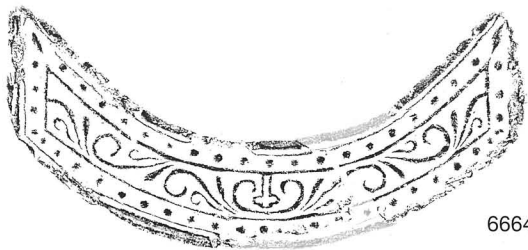

6664 F(1)

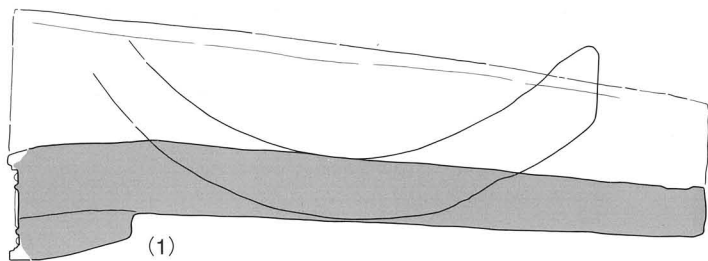

(1)

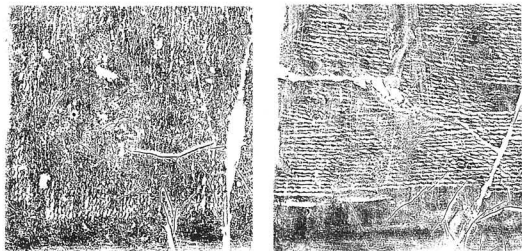

6664 F(1)凸面(1:5) 6664 F(2)凸面(1:5)

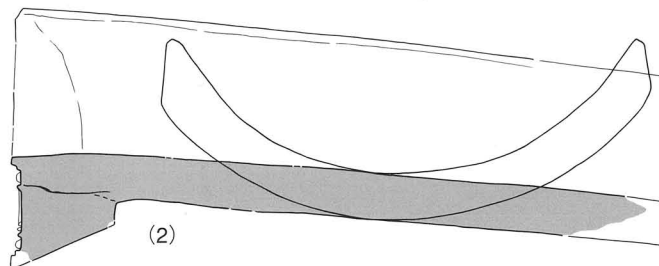

(2)

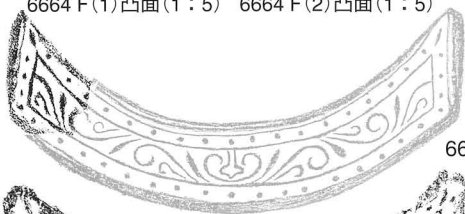

6664 N

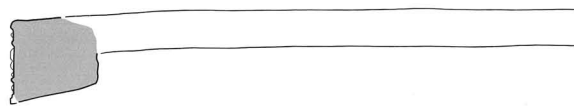

6666 A

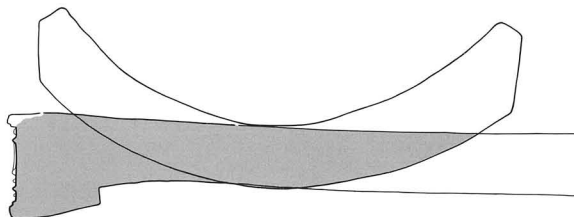

6675 A

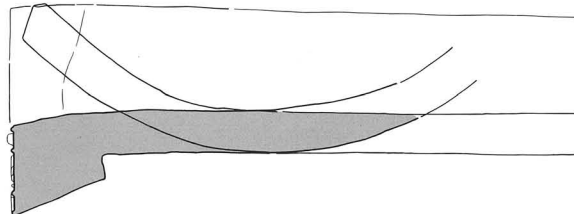

6682 A

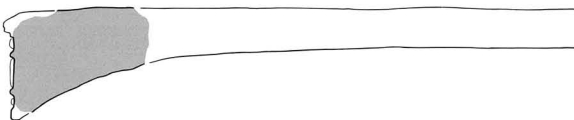

6685 A

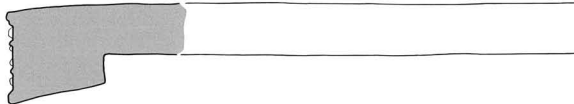

6685 B

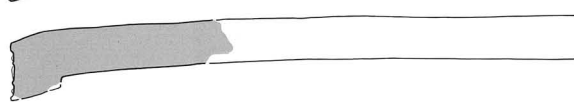

6685 C

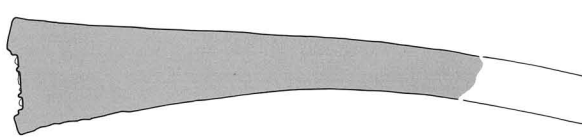

型式・種	最大幅	厚さ	内区		上外区		下外区		脇区		全長	顎形態	点数
			厚	文様	厚	文様	厚	文様	幅	文様			
6664 F	276	39	25	KK	8	S 19	9	S 21	9	S 3	360	段 I S	22
N		32	20	KK	5	S 18	7	S 17	6	S 4		段 I S	1
6666 A	226	40	26	KK	6	S 19	7	S 17	6	S 3		段 I S	9
6675 A	270	48	22	KK	13	S 15	13	LV 16	13	LV 3		段 I S	2
6682 A		37	19	KK	8	S 17	8	S 17	7	S 3		曲 I	2
6685 A	230	32	15	KK	8	S 15	9	S 15	9	S 2		曲 I S	5
B		40	12	KK	6	S 15	7	S 15	7	S 1		曲 I SS	1
C		27	15	KK	6	S 17	7	S 17	8	S 2		直	1



6666A



6675A



6664N



6685B



6682A



6682A 凸面



6685A



6685C



6664F (2) 顎部貼り付け手法



6664F (1)



6664F (1) 顎部貼り付け手法



6681 A



6681 B(1)

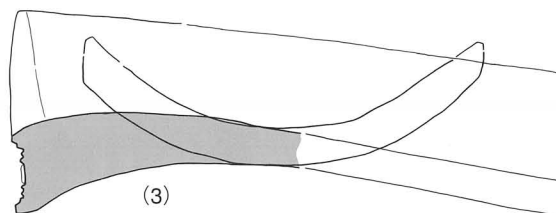
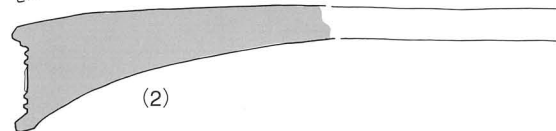
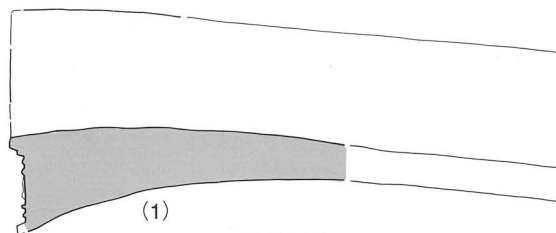
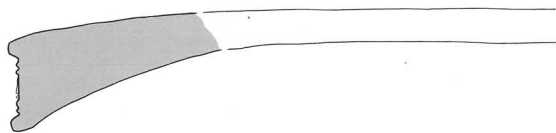

6681 B(2)凸面 (1:5)

6681 B(3)凸面 (1:5)



(3)

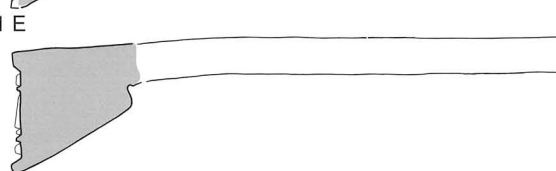
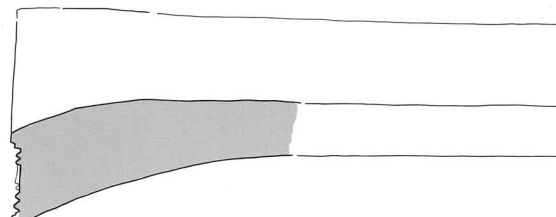

6689 Aa



6689 C

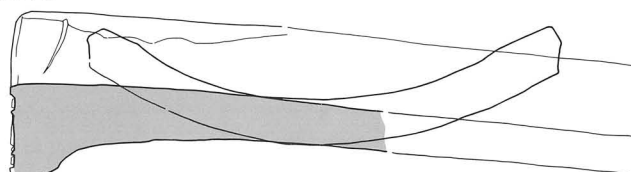

6694 A

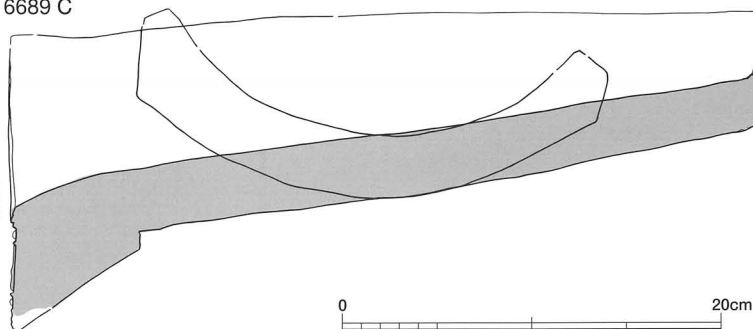

0 20cm

型式・種	最大幅	厚さ	内区		上外区		下外区		脇区		全長	顎形態	点数
			厚	文様	厚	文様	厚	文様	幅	文様			
6681 A		28	16	KK	5	K	5	K	7	K		曲Ⅱ	35
B	276	33	18	KK	7	K	8	K	10	K		曲Ⅰ,Ⅱ	62
E	262	33	18	KK	7	K	8	K	8	K		曲Ⅰ	64
6689 Aa		48	29	KK	10	S 17	10	S 17	11	S 3		段Ⅰ L	1
C		38	23	KK	8	S 14	8	S 13	7	S 3		曲Ⅱ	4
6694 A	288	43	28	KK	8	S 15		S 14	7	S 2	395	段Ⅰ SS	8



6681A



6694A



6689Aa



6689C

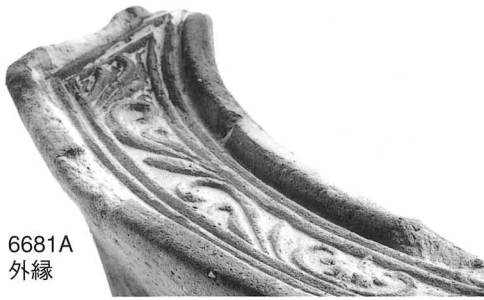

6681A
外縁



6681E



6681B (1) 外縁



6681B
(1)

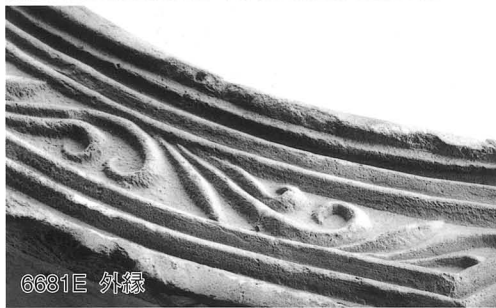

6681E 外縁



(3)



6681B (2) 凸面

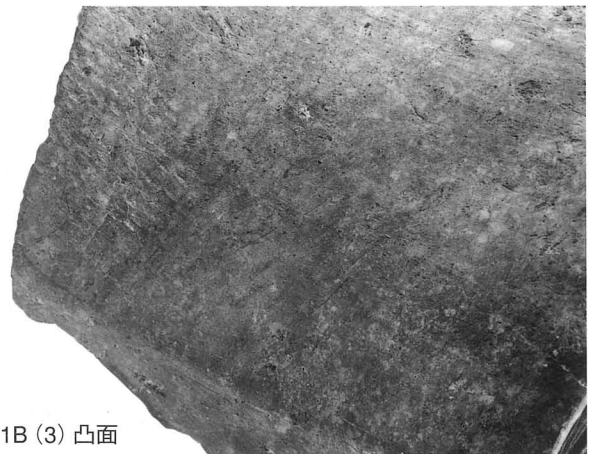

6681B (3) 凸面

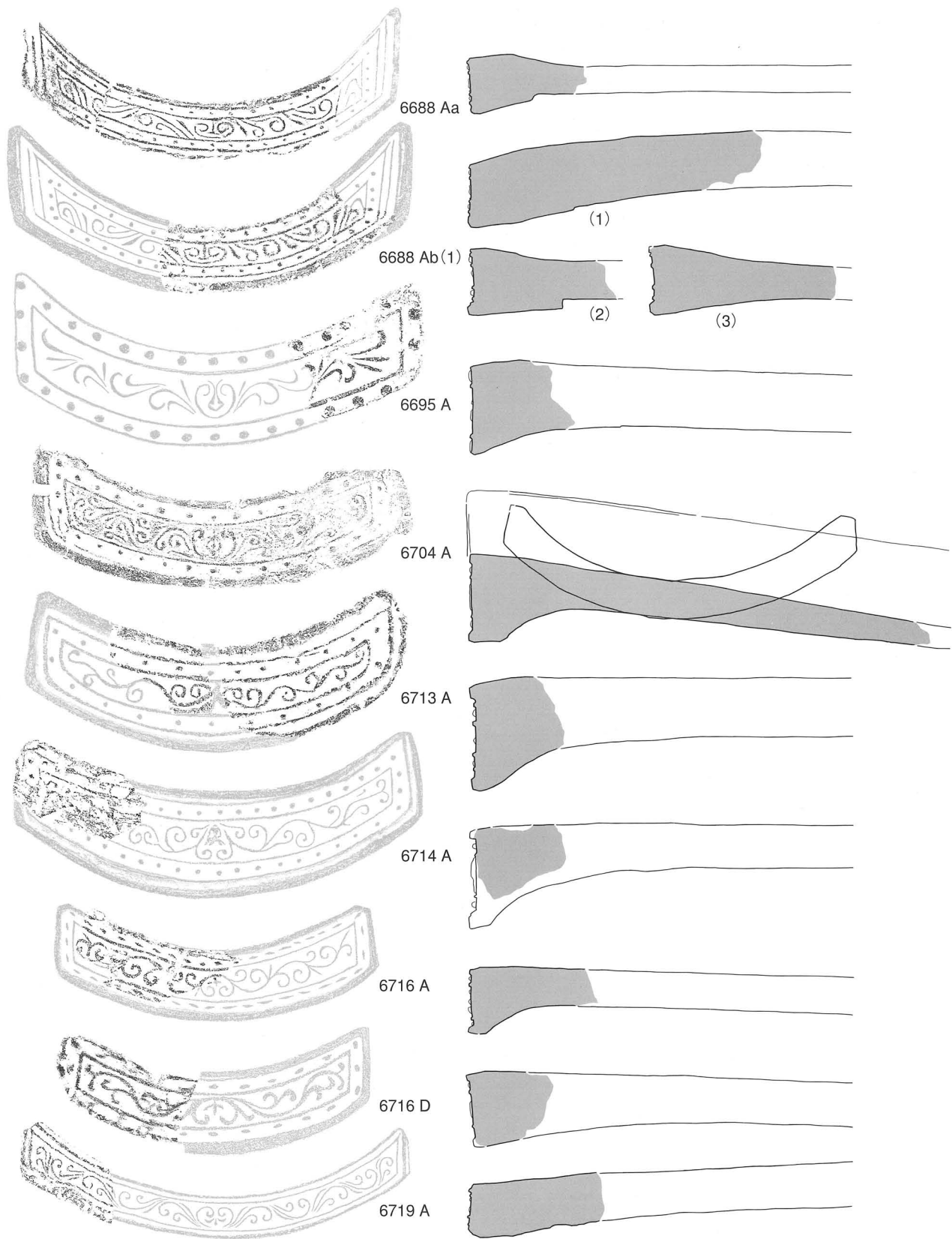

型式・種	最大幅	厚さ	内区		上外区		下外区		脇区		全長	顎形態	点数
			厚	文様	厚	文様	厚	文様	幅	文様			
6688 Aa		34	16	KK	9	S 17	10	S 17	20	SL4 R5K		段Ⅱ	3
Ab		35	17	KK	10	S 17	8	S 17	20	SL4 R5K		直段Ⅱ	16
6695 A		61	36	KK	12	S 13	12	S 13	10	S 4		曲Ⅰ	2
6704 A	265	47	28	KK	10	S 14	9	S 13	10	S ^{L5} _{R4}		曲Ⅱ	1
6713 A		53	24	KK	15	S 10	15	S 9	20	S 2		曲Ⅰ	2
6714 A		48	30	KK	8	S 20	9	S 18	10	S 4		曲Ⅰ	1
6716 A		37	23	KK	7	GS 17	7	GS 17	8	GS ^{L4} _{R3}		曲Ⅱ	2
D		57	24	KK	11	GS 9	11	GS 9	12	GS 3		直	1
6719 A		23	18	KK	2	-	3	-	5	-		直	2



6695A



6704A



6719A



6713A



6714A



6688Ab (1)



6716A



6688Aa



6716D



6688Aa
凸面・顎部