

平城京左京二条二坊・三条二坊

発掘調査報告

——長屋王邸・藤原麻呂邸の調査——

図版編

凡例

- 1 遺構と遺物の図面はPl. (plan, plate) 番号、写真はPh. (photograph) 番号で示した。
- 2 1/200の遺構図面 (Pl.3~36) の割付けは、Pl. 2 に図示した。
- 3 遺構図面には国土方眼座標第VI系にもとづく座標値を示した。
- 4 遺構には一連の番号をつけ、その前にSA:築地・塀, SB:建物, SC:廊, SD:溝, SF:道路, SK:土坑, SX:その他などの分類表記を付記した。
- 5 土器の実測図は、断面図の色の濃淡によって、土師器と黒色土器を濃く、施釉陶器を淡く、須恵器をその中間で表示した。
- 6 木製品実測図の断面にしめす線は、木材の年輪を模式的にあらわしている。
- 7 1/200の遺構写真 (Ph. 2~31) の割付けは、Ph. 1 の裏面に図示した。
- 8 軒瓦の写真 (Ph. 105~156) は、右頁に瓦当文様をおき、左頁にそれらの製作技法や範傷の進行状況を示す資料を対置させた。

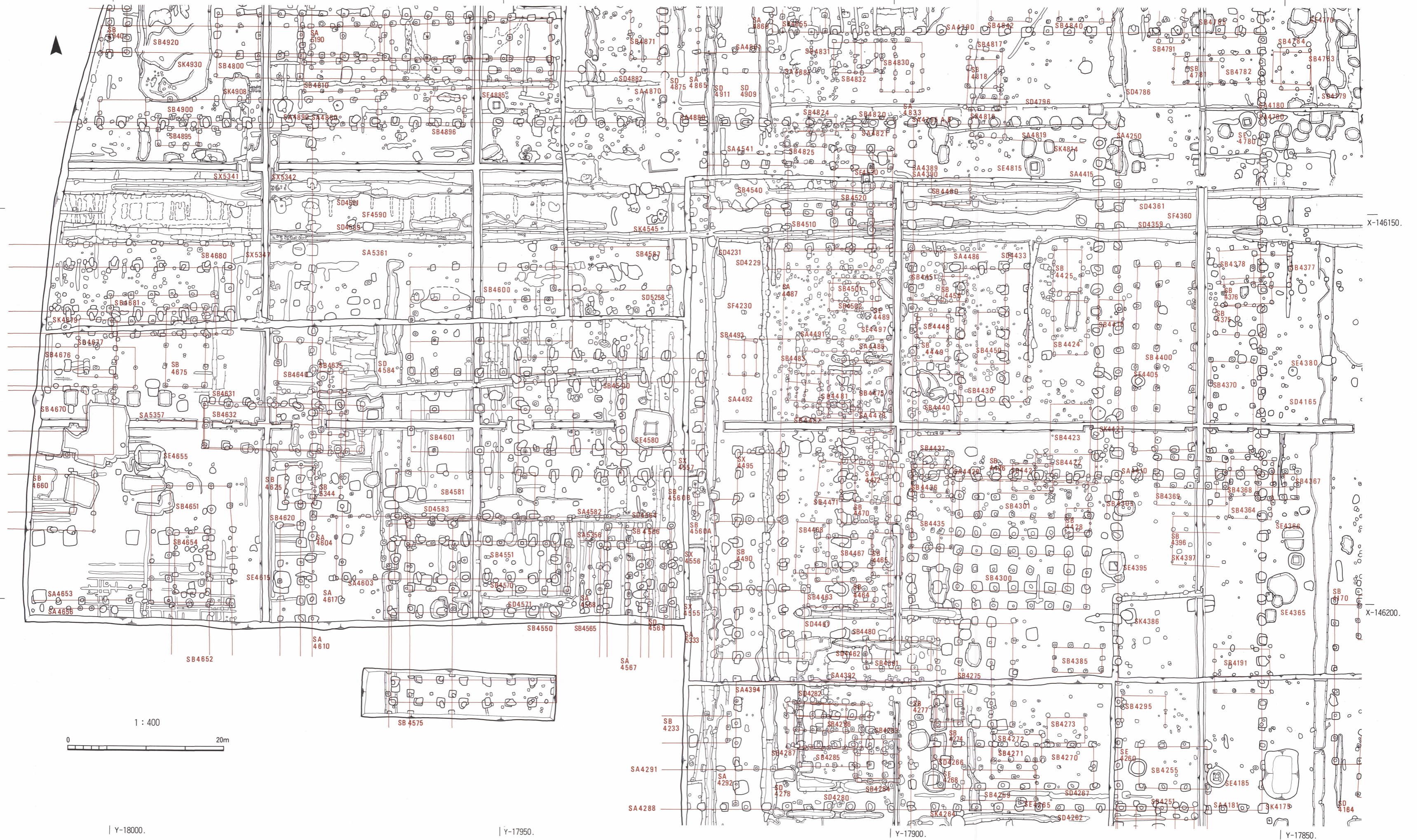

Y-18000.

Y-17950.

Y-17900.

Y-17850.

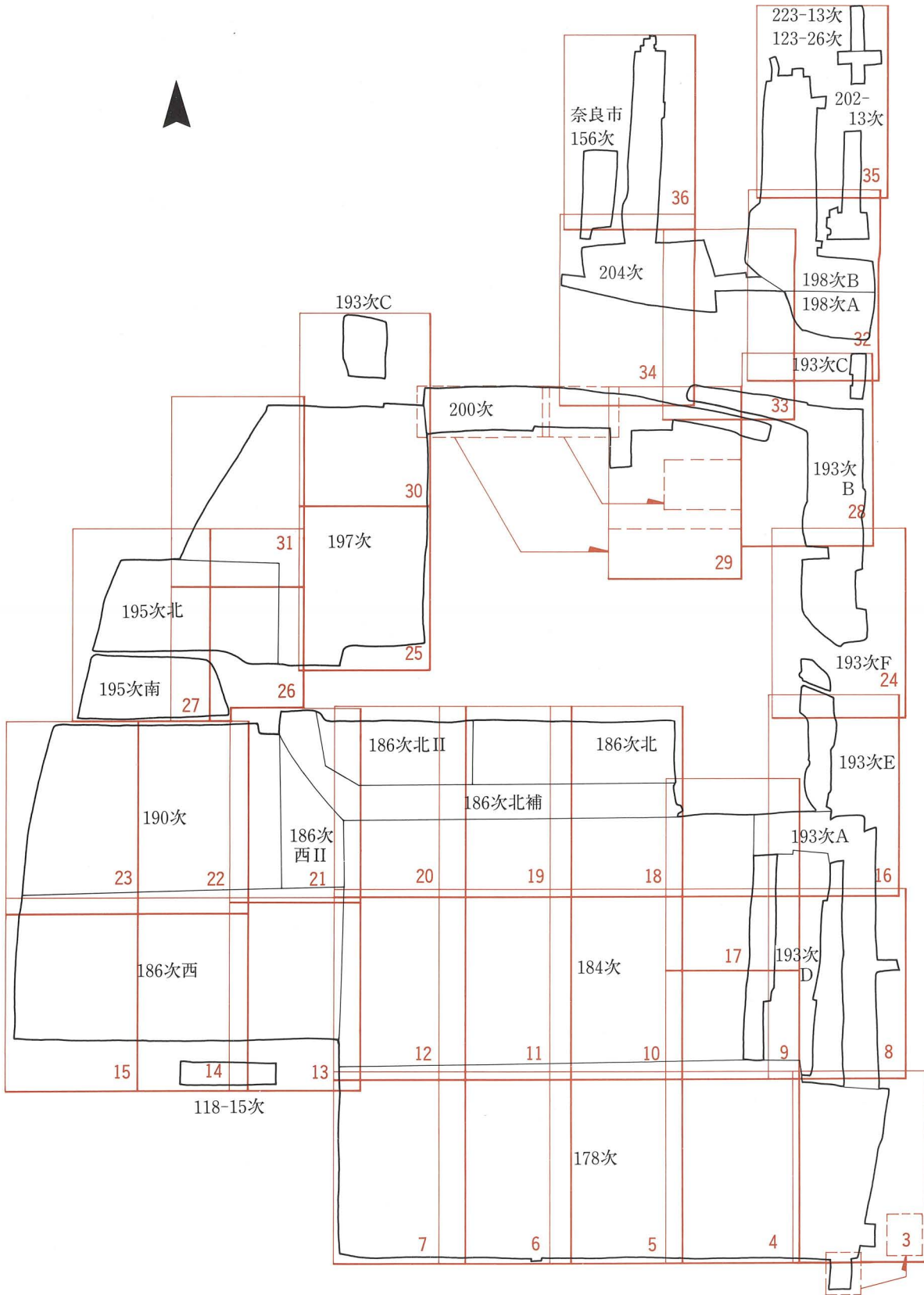

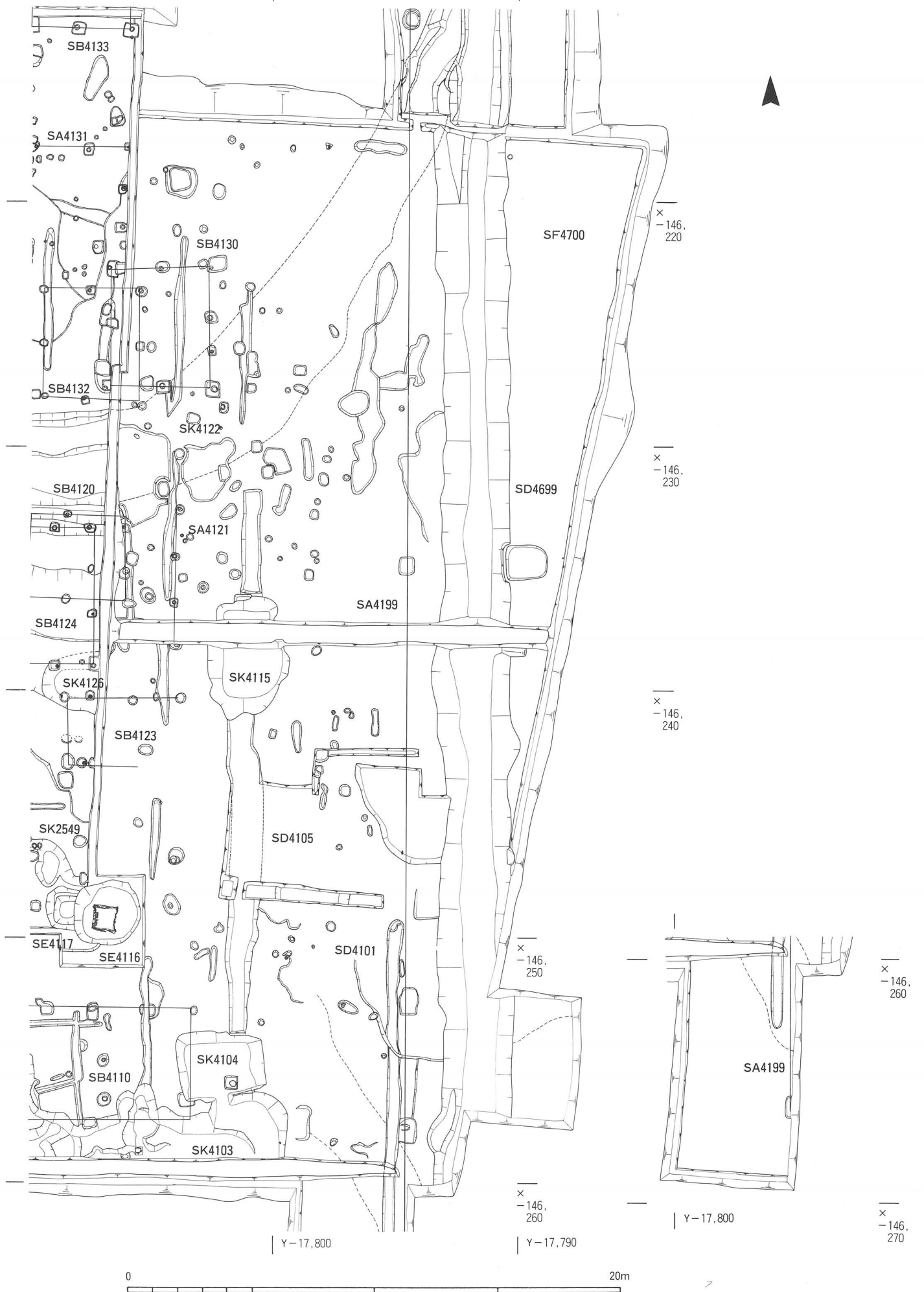

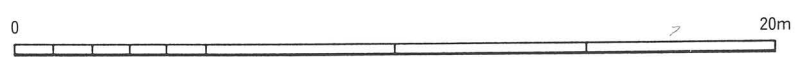
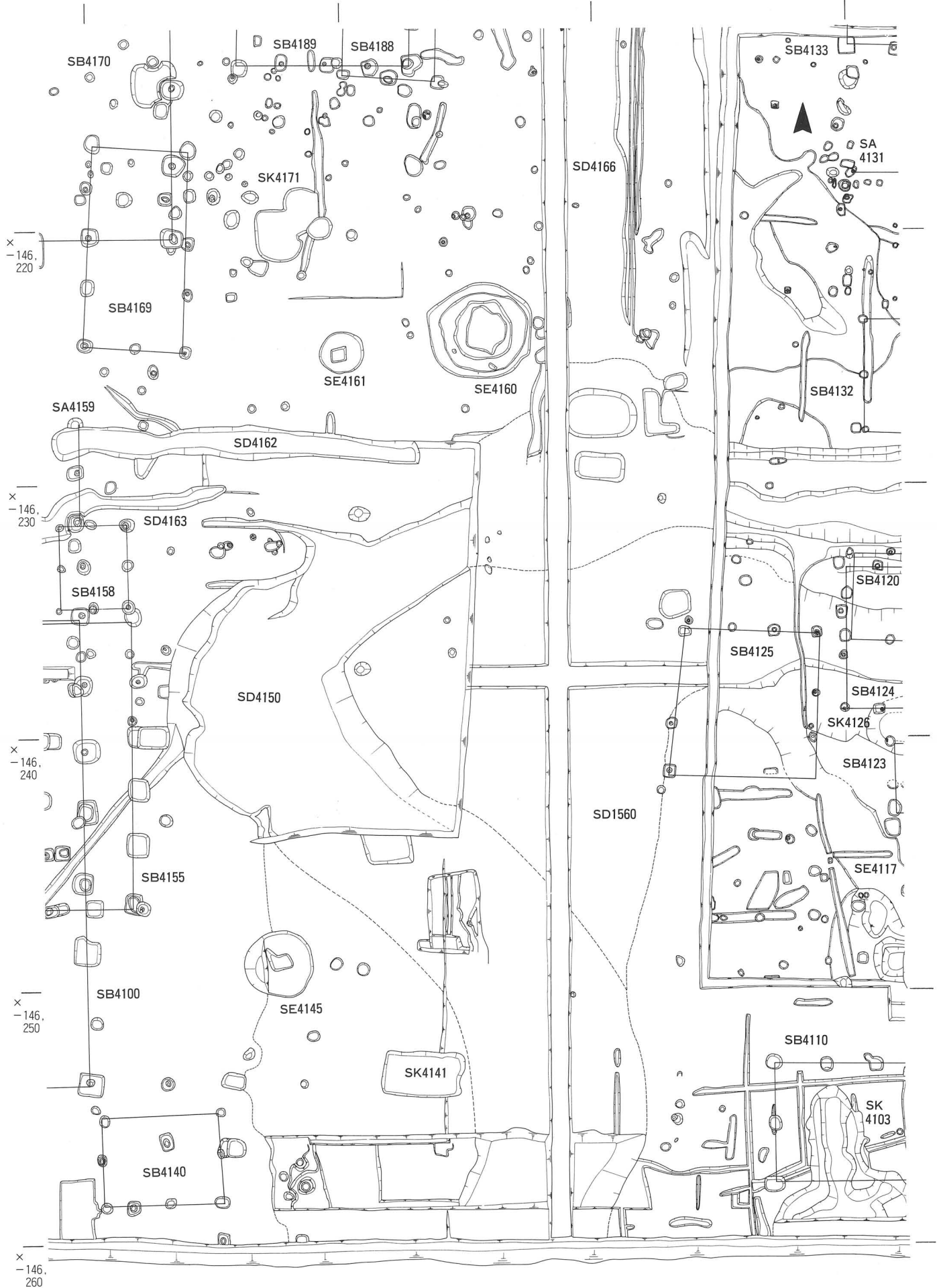

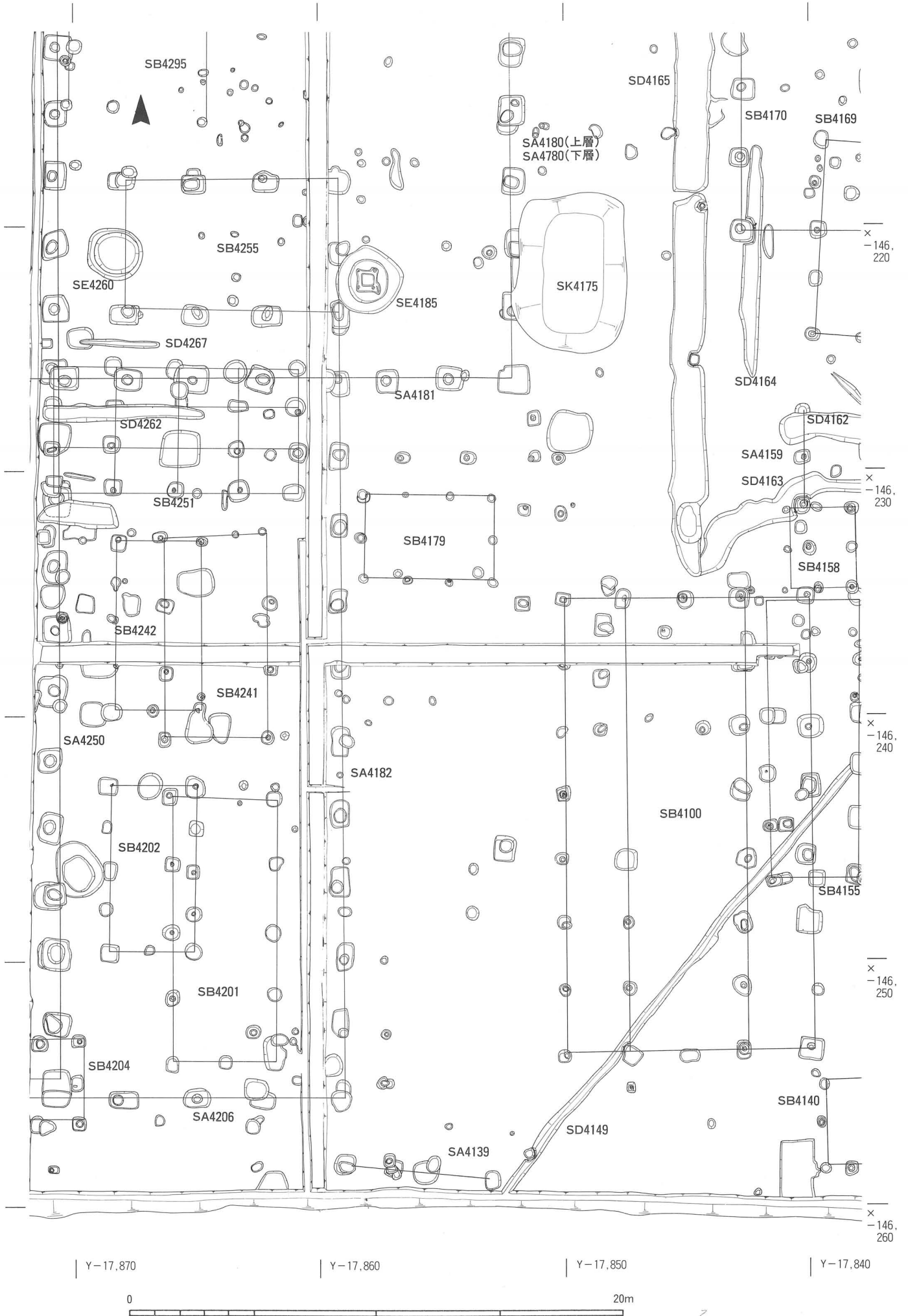

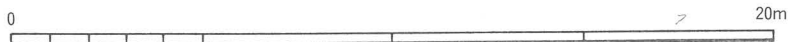
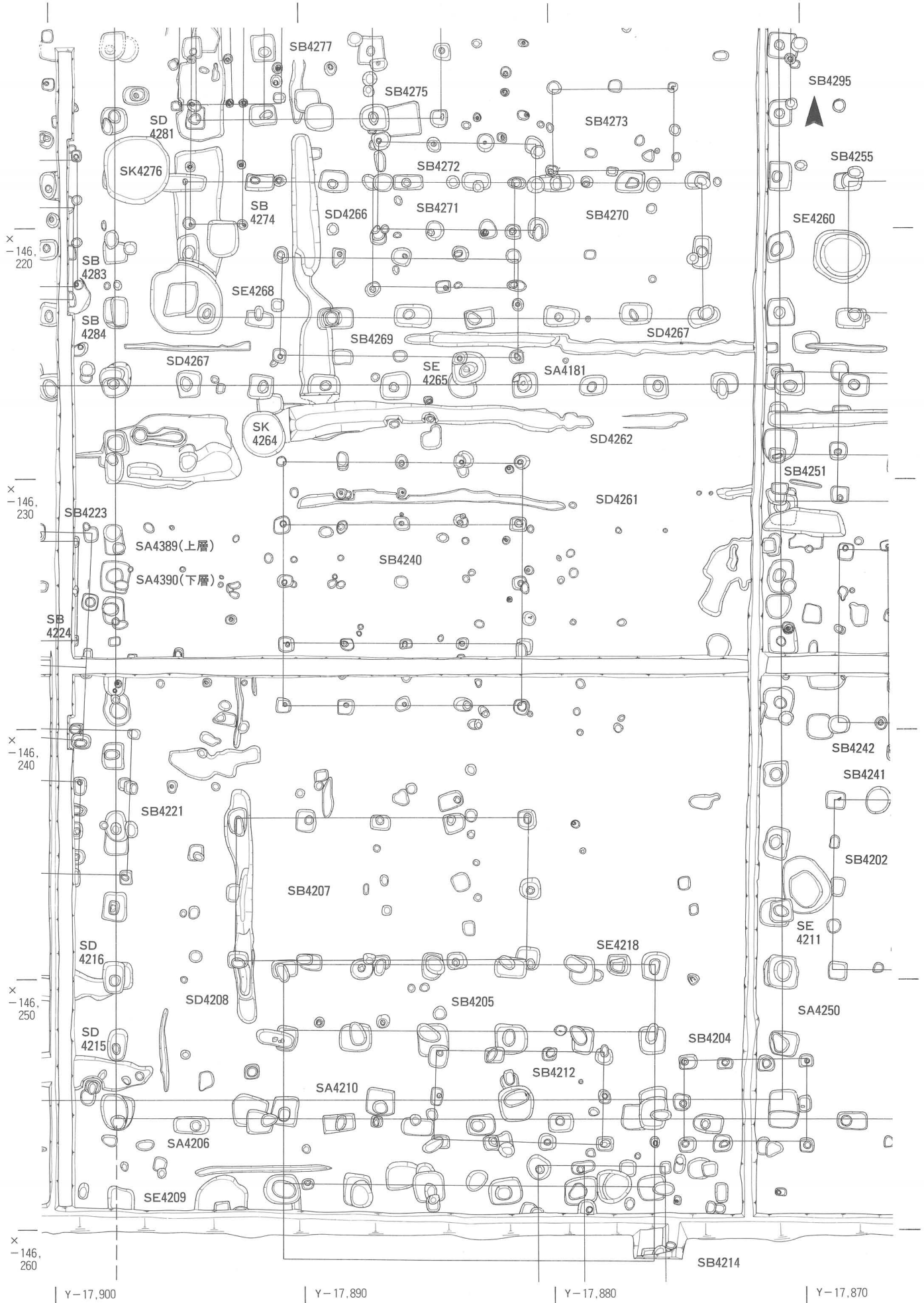

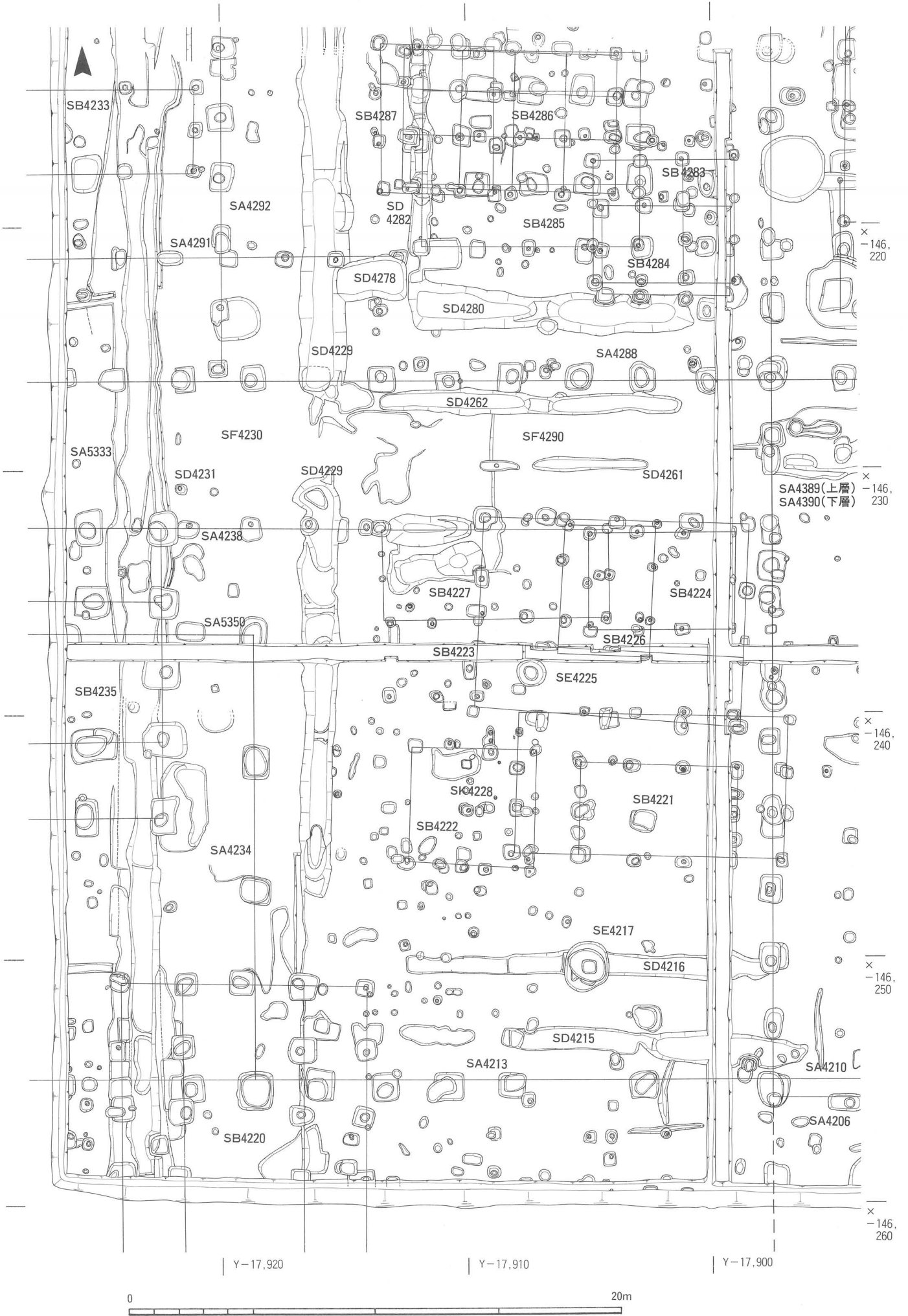

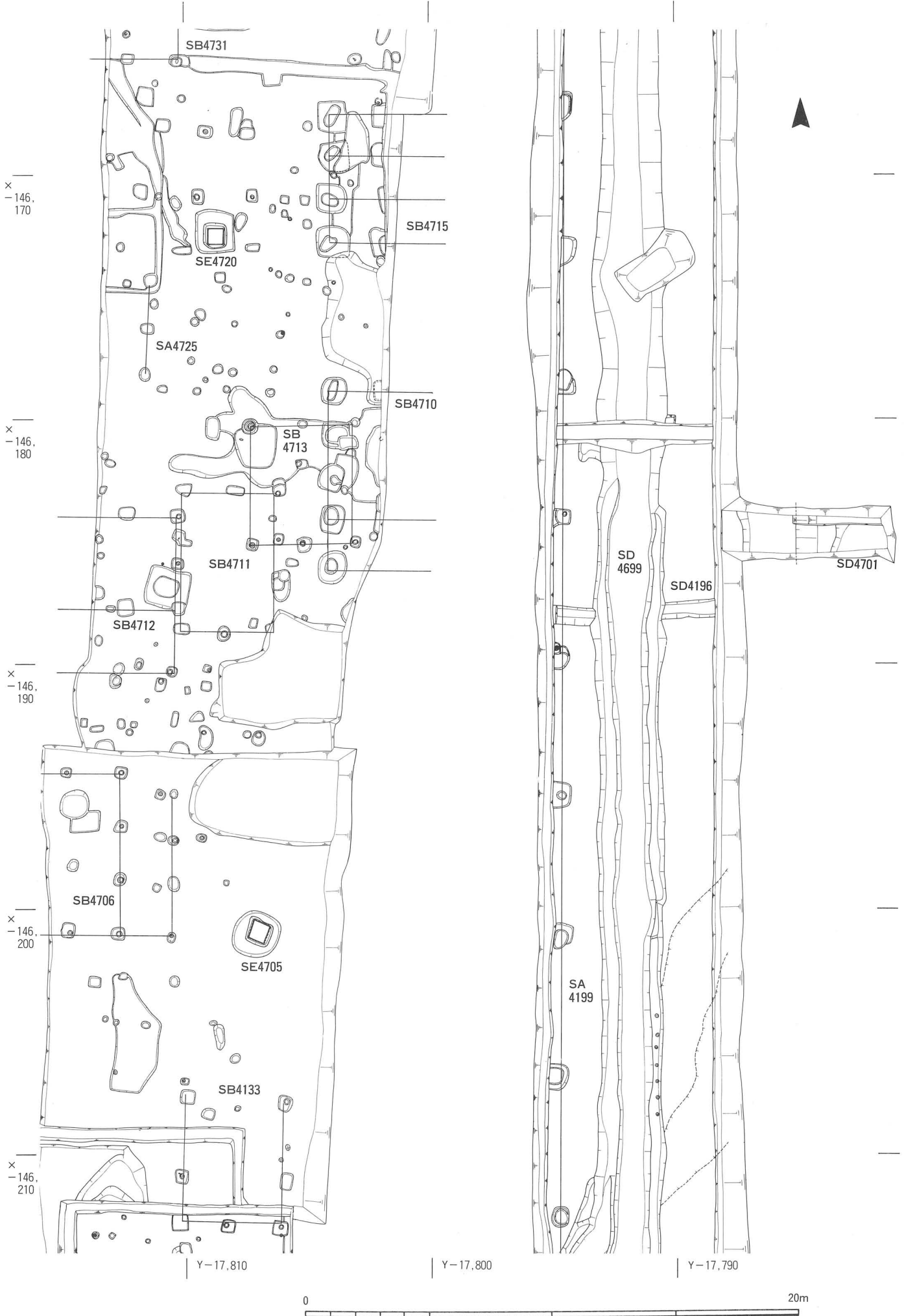

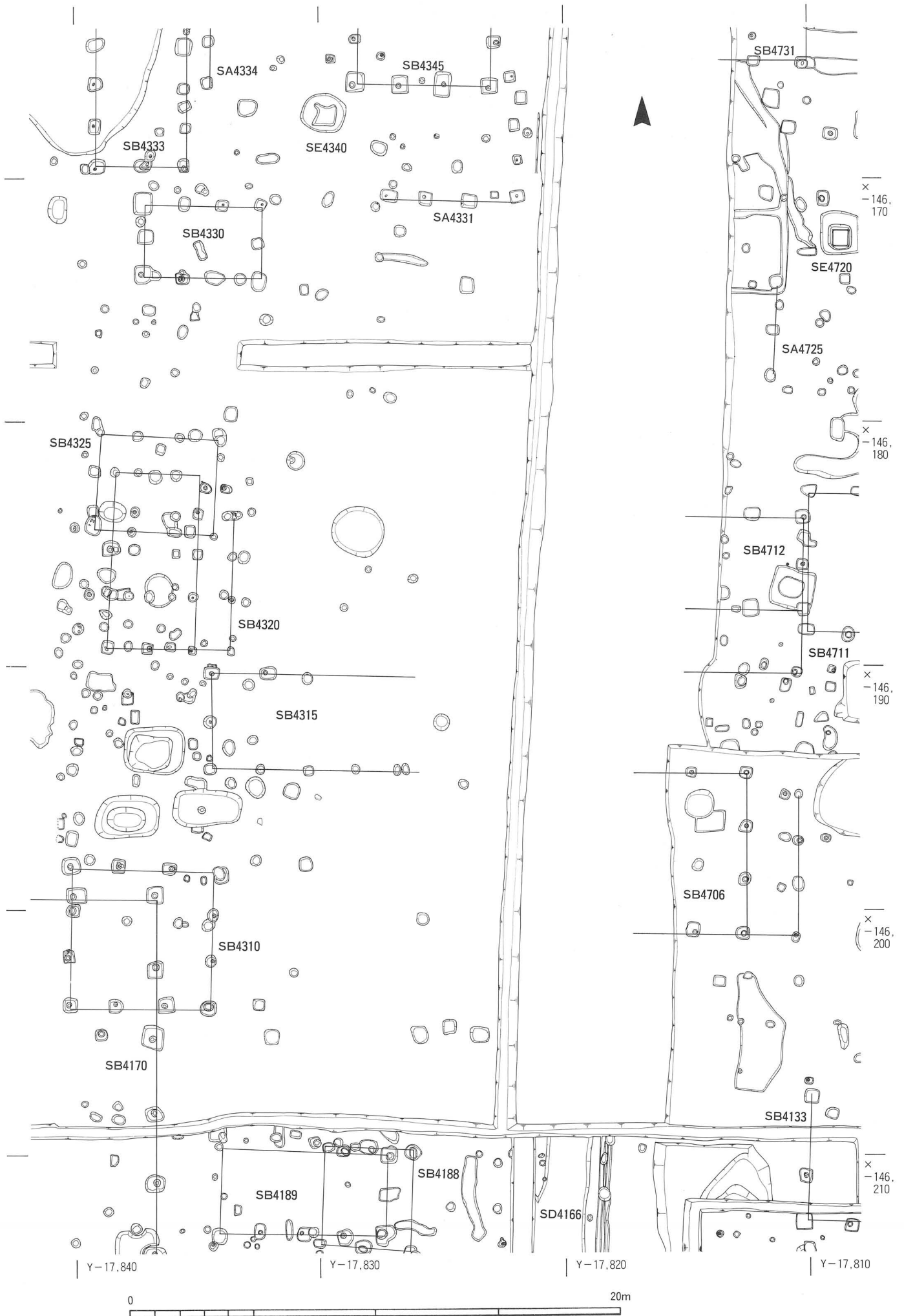

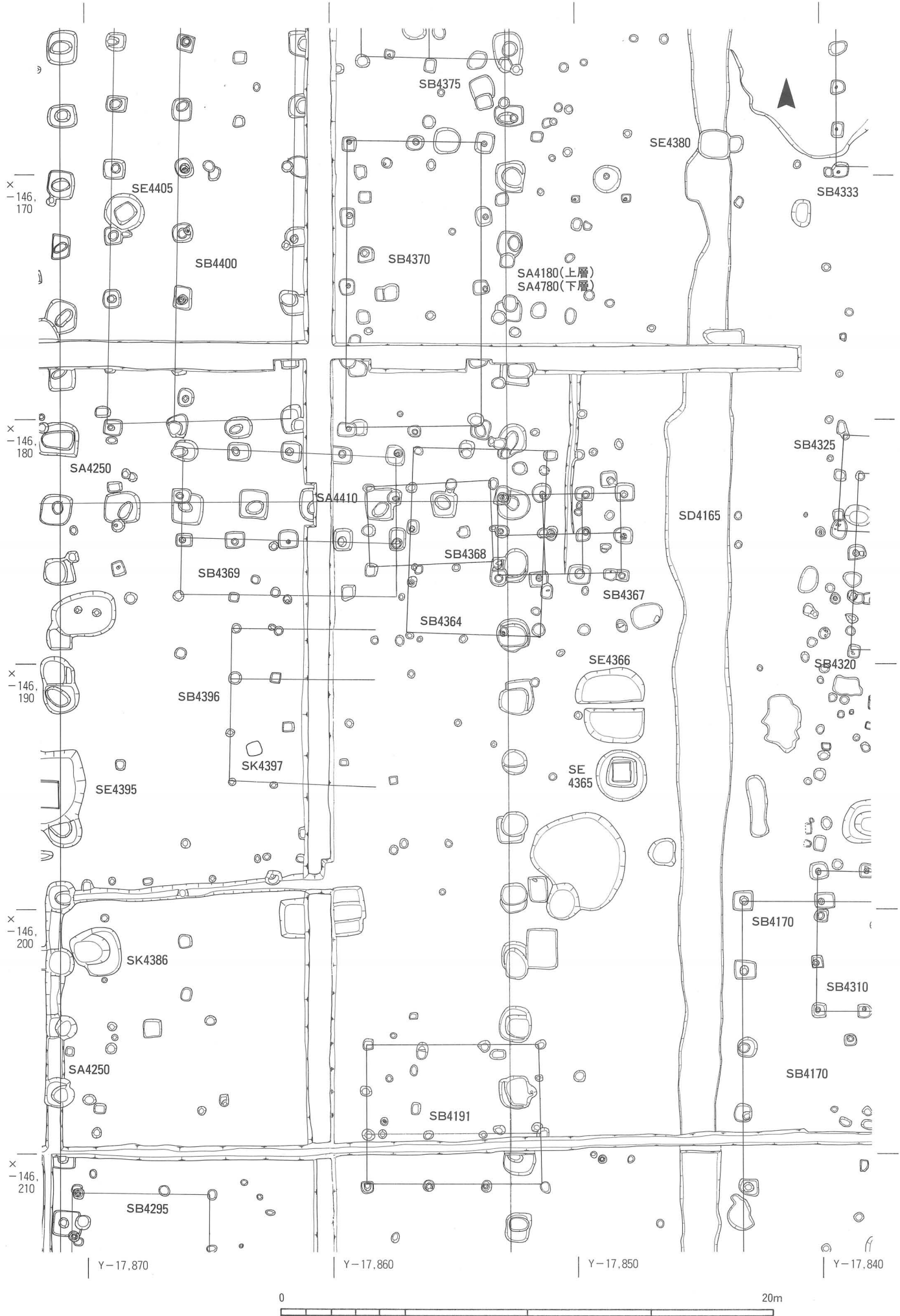

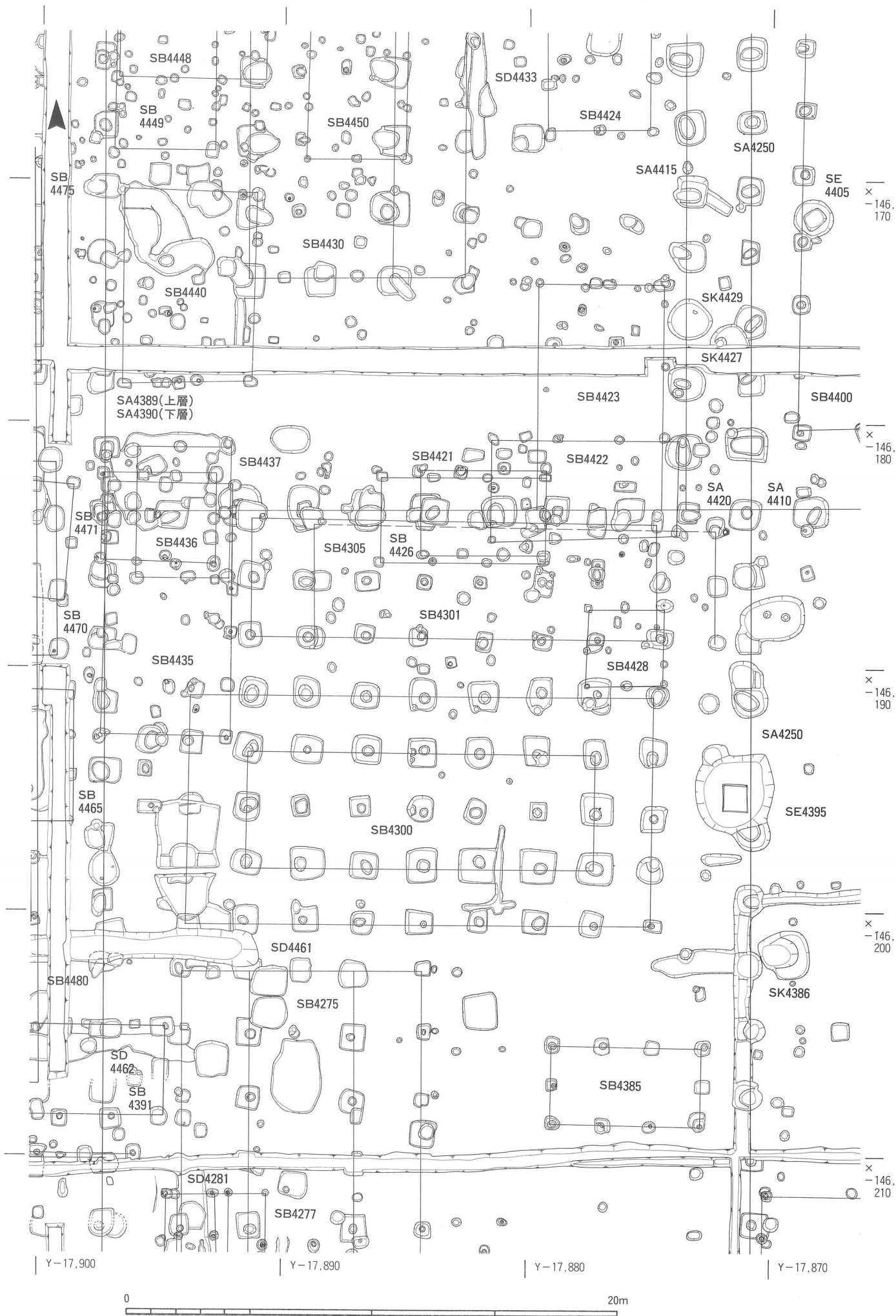

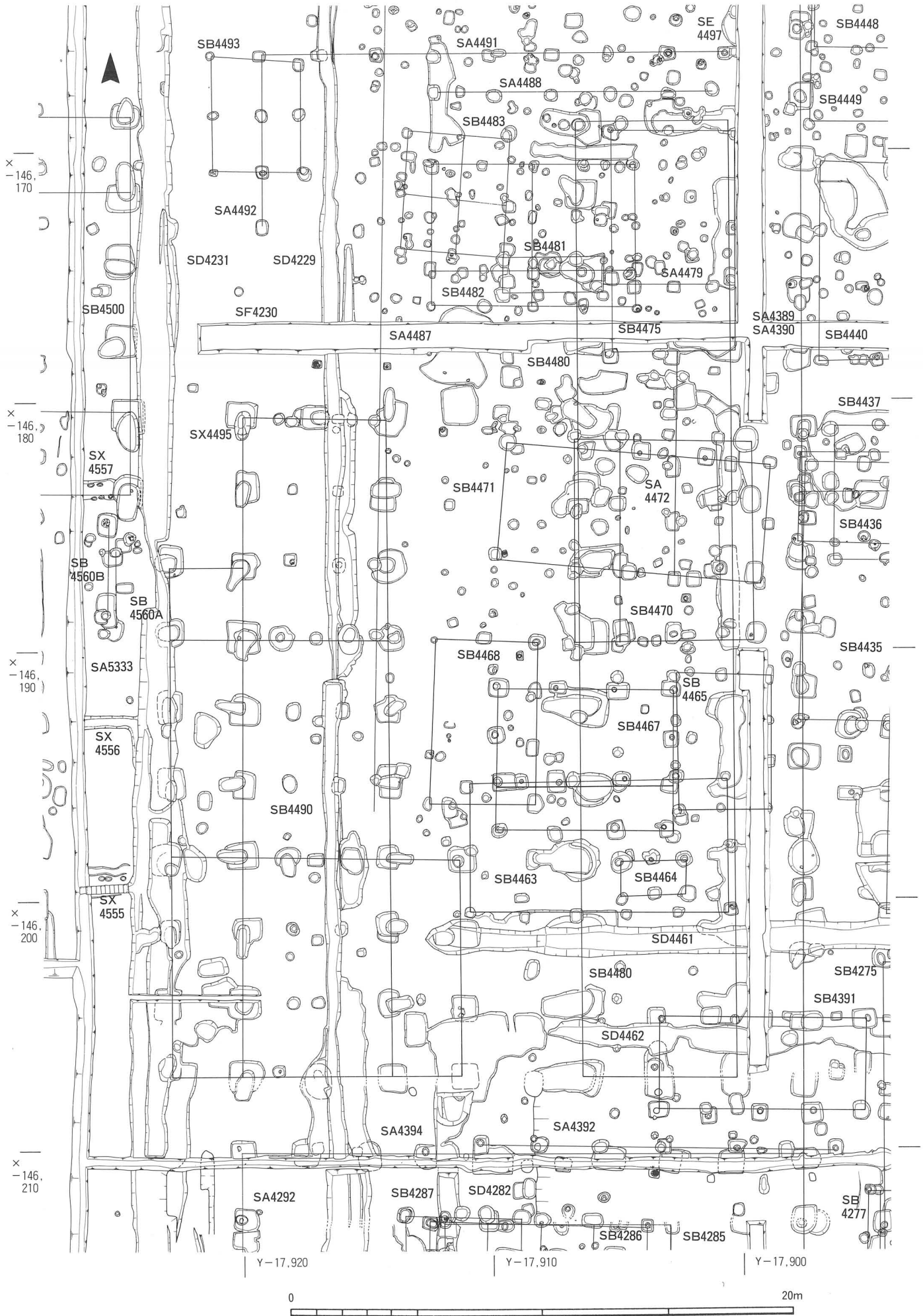

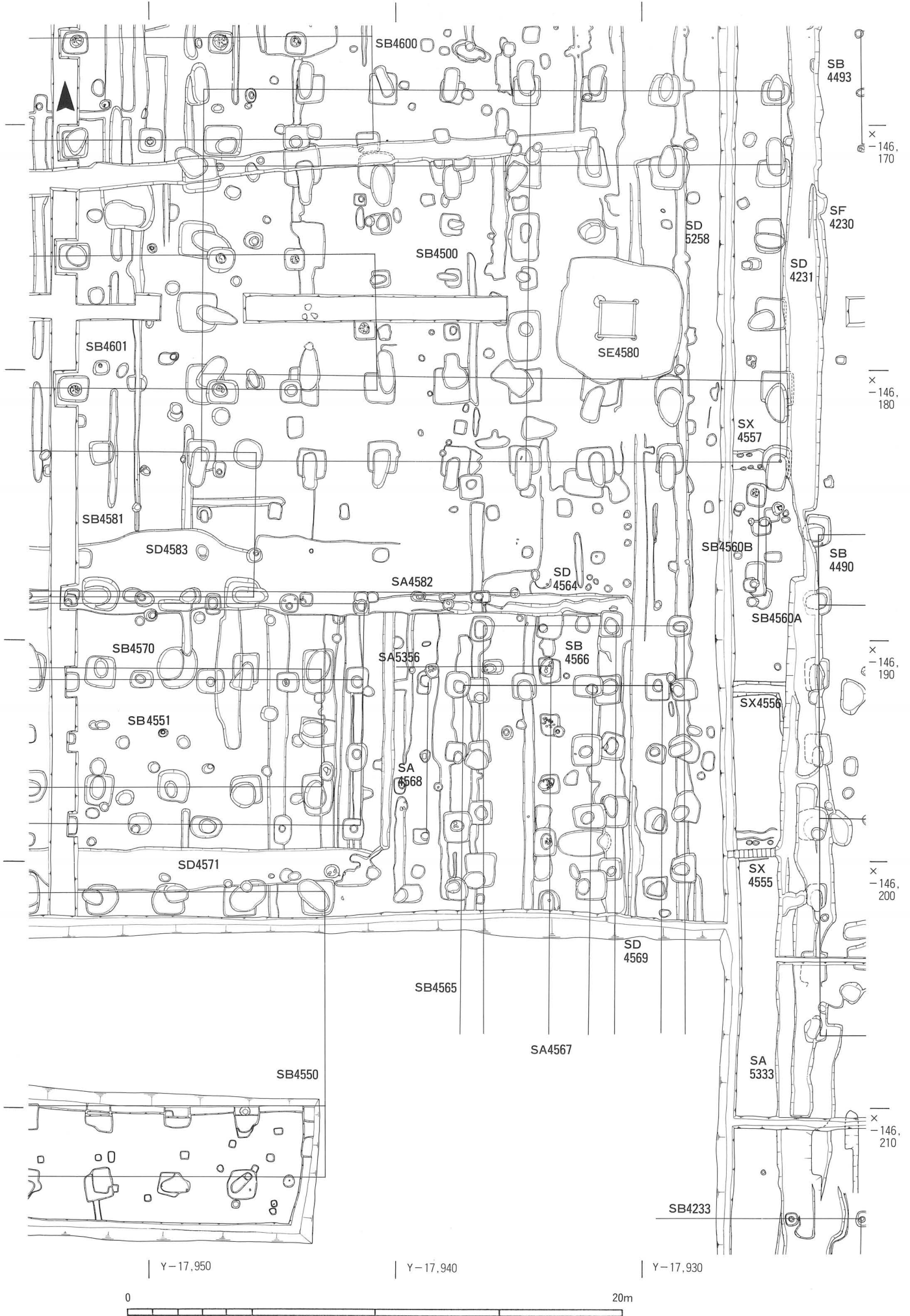

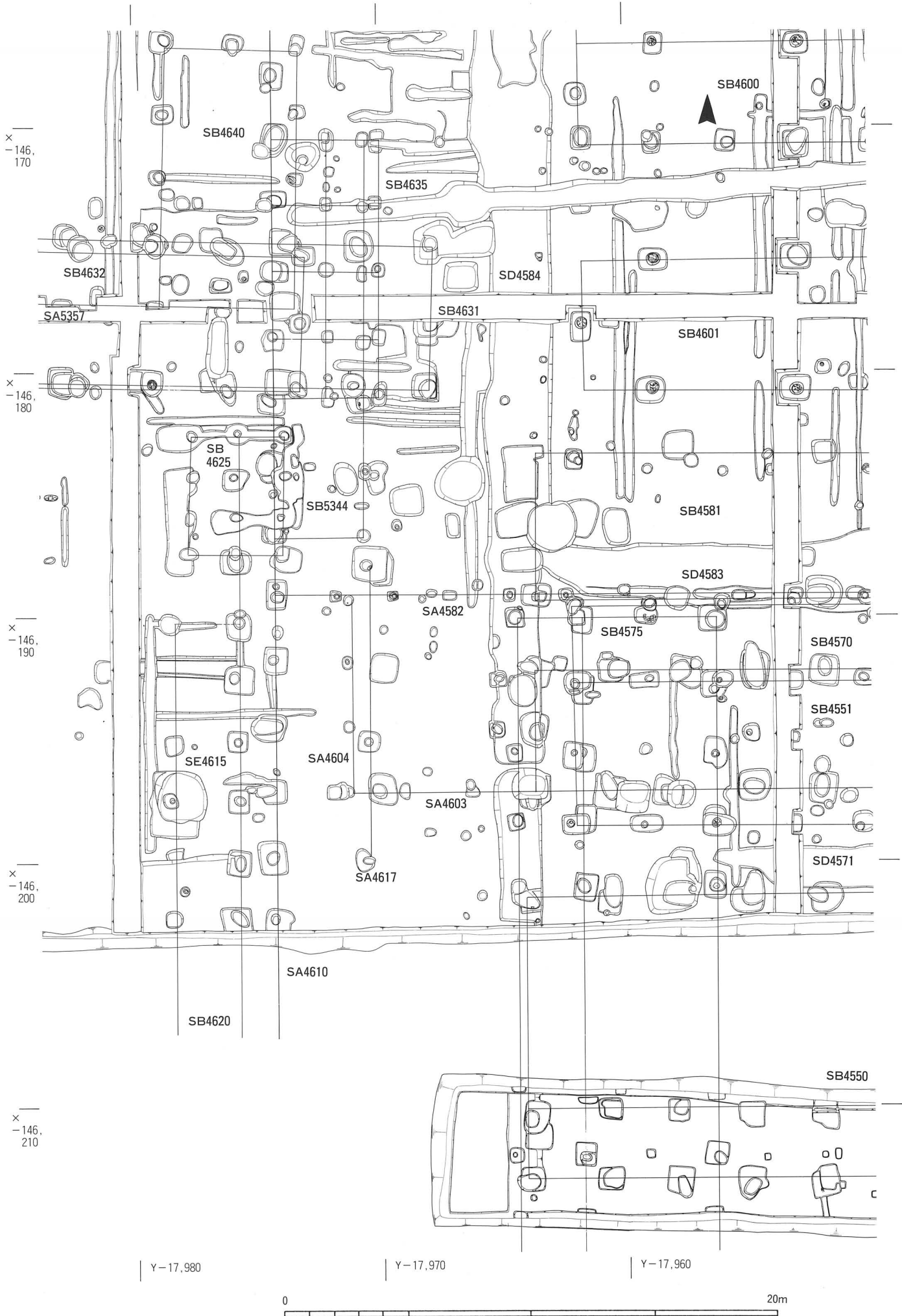

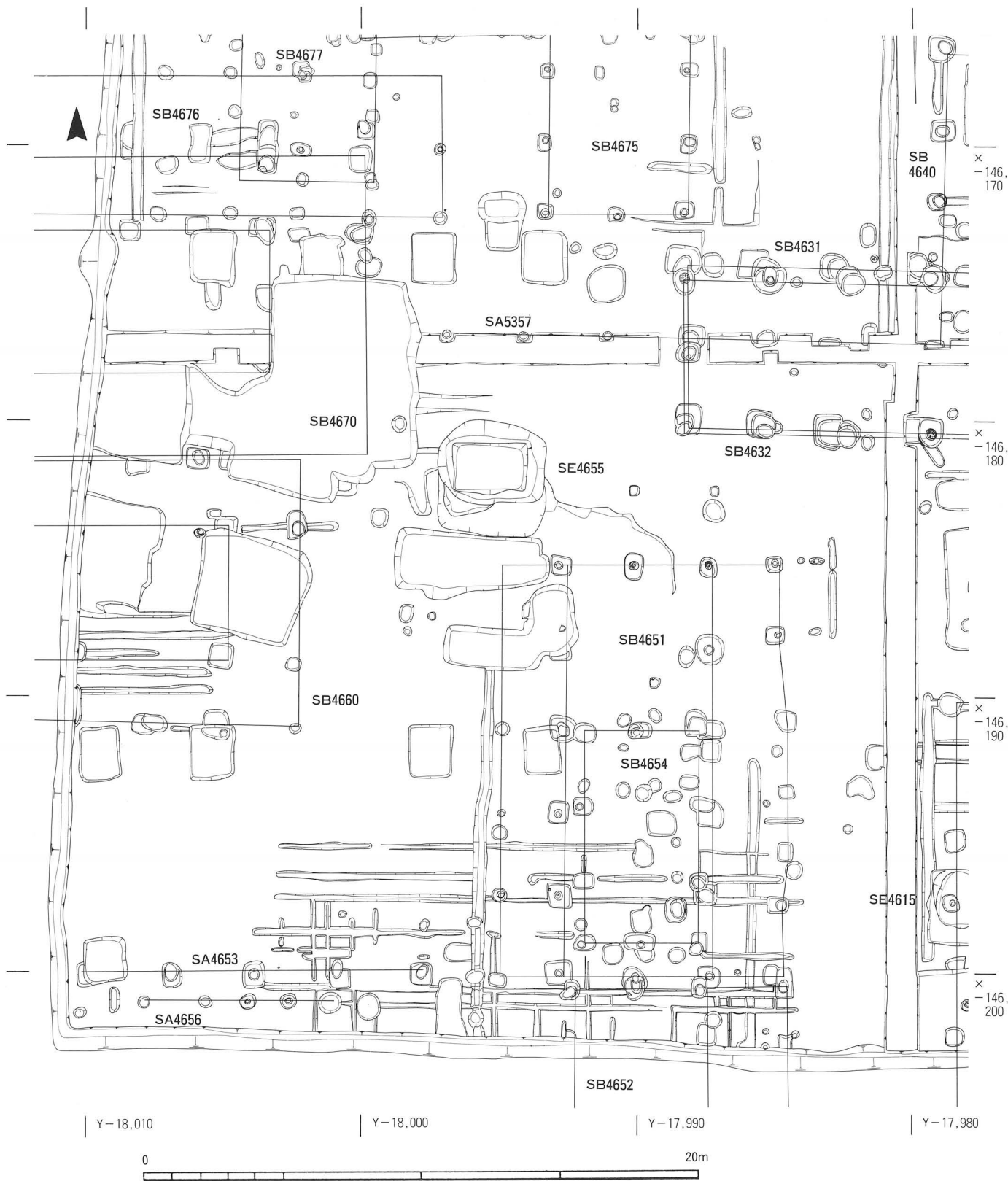

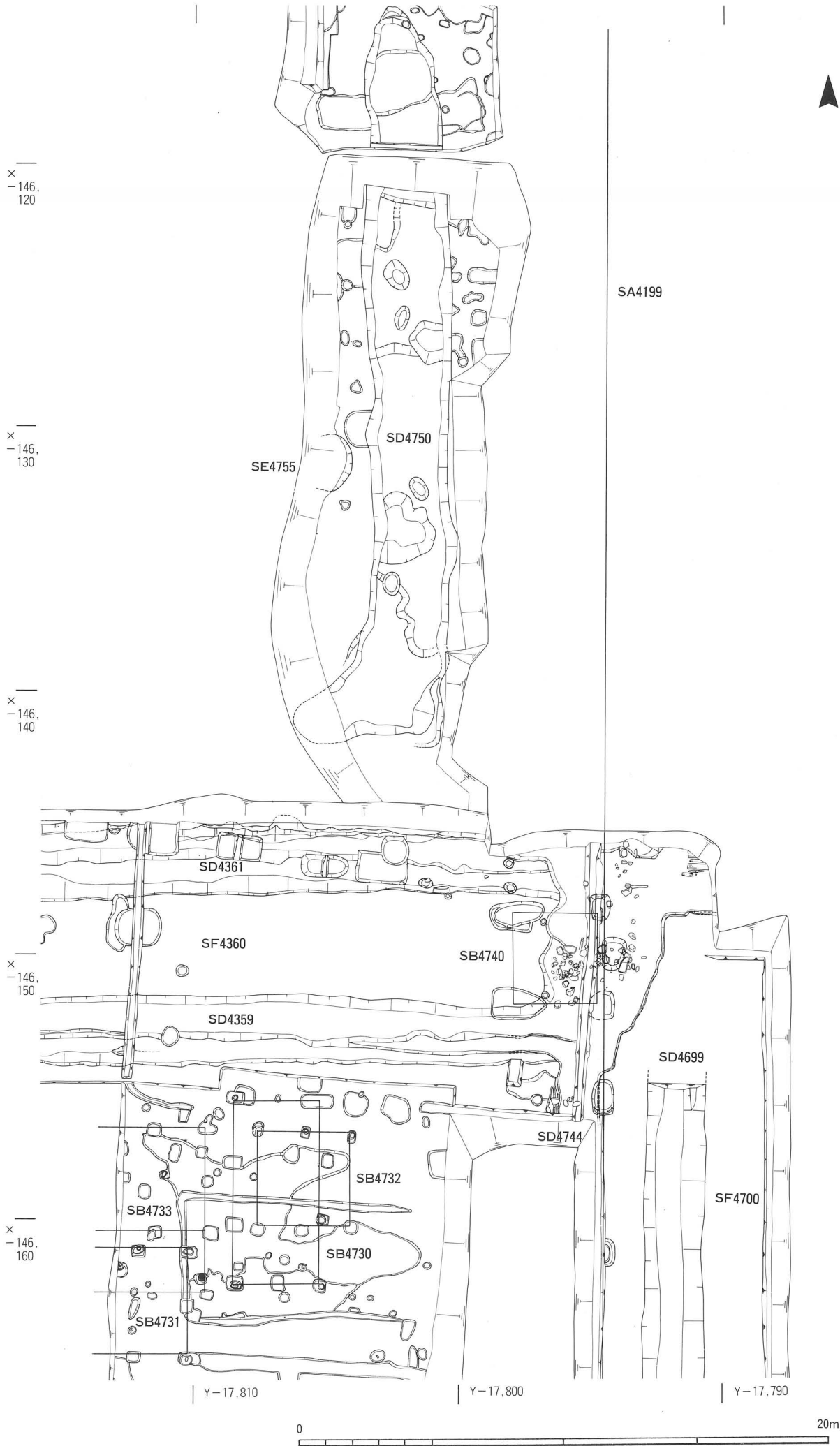

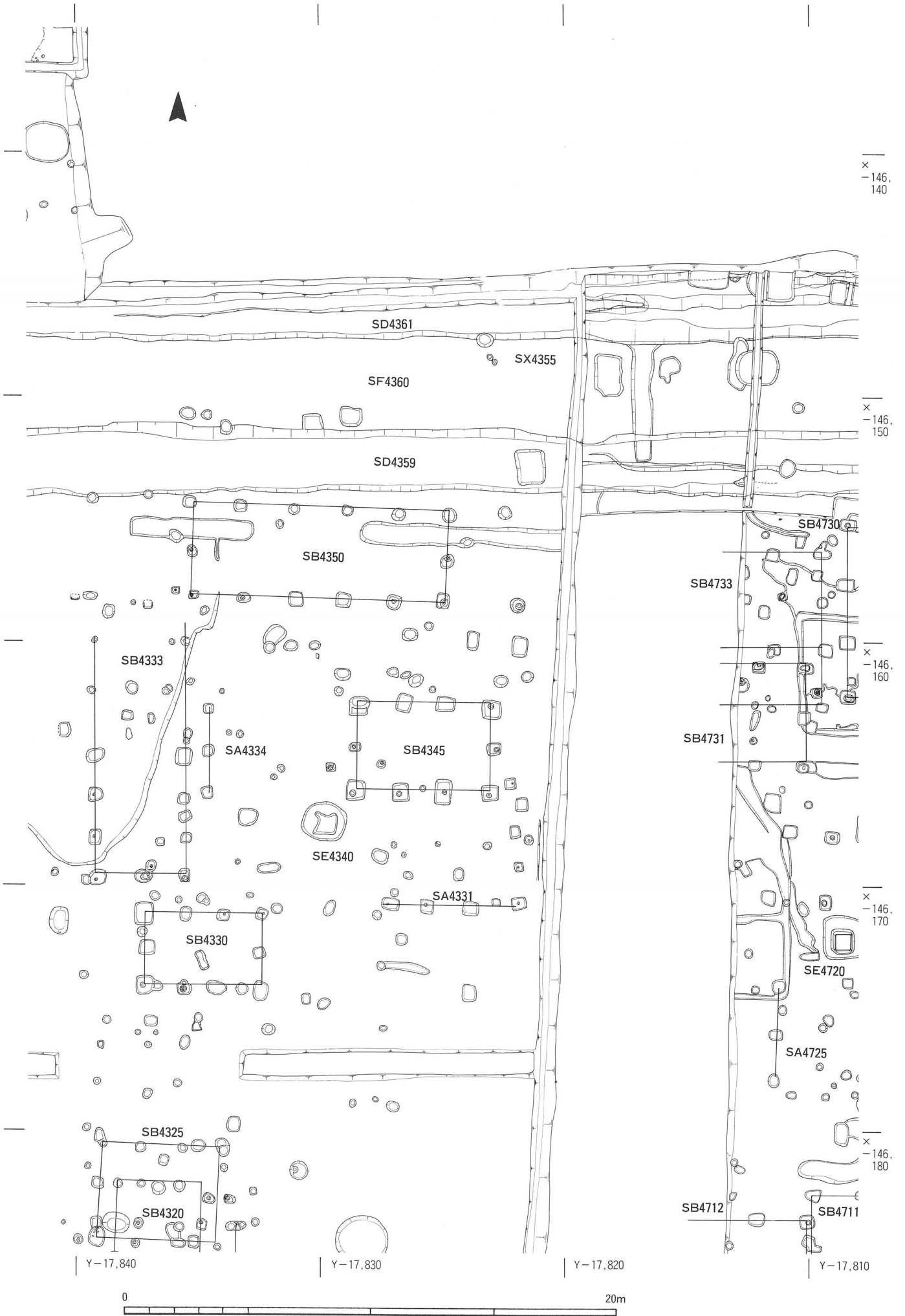

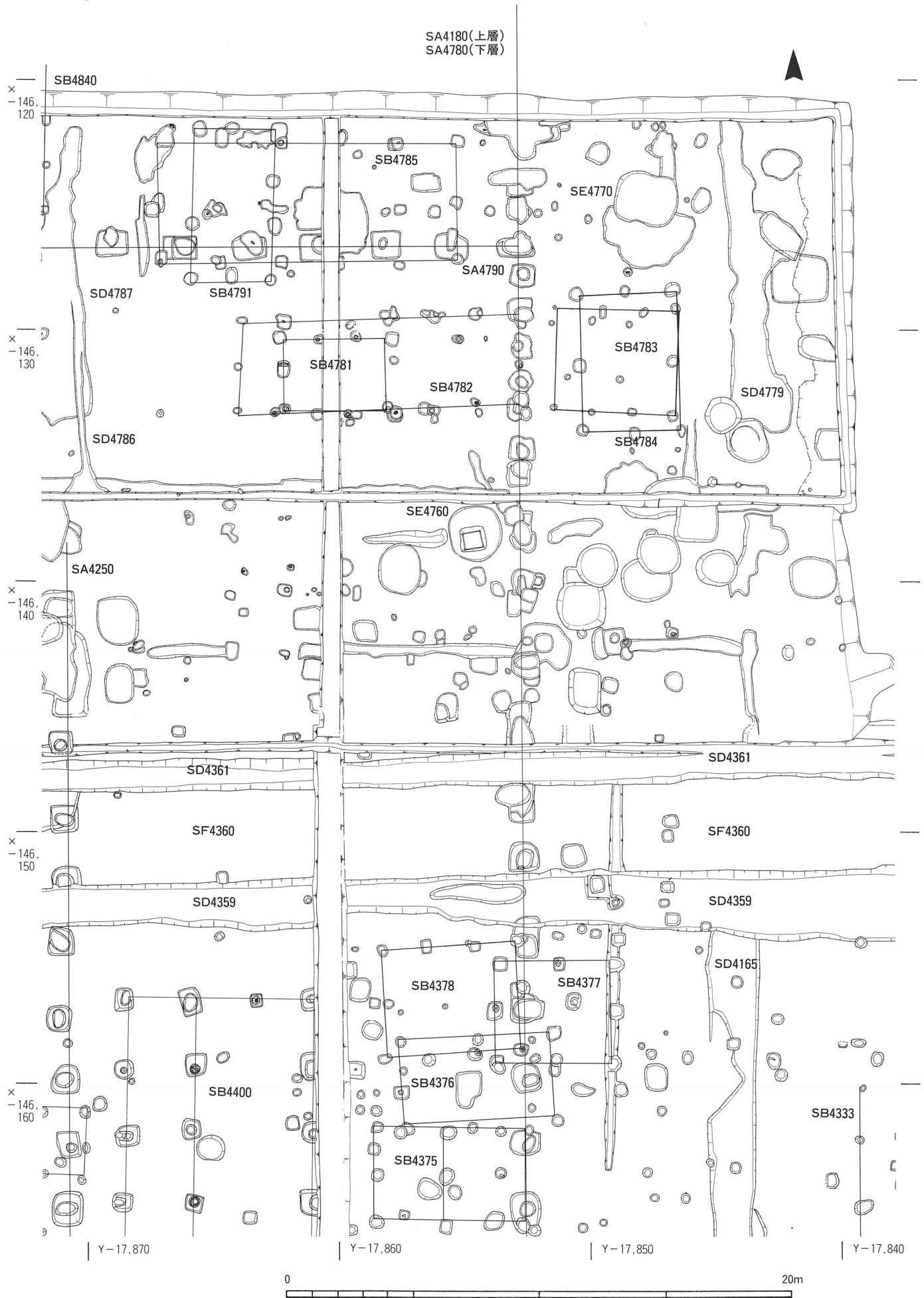

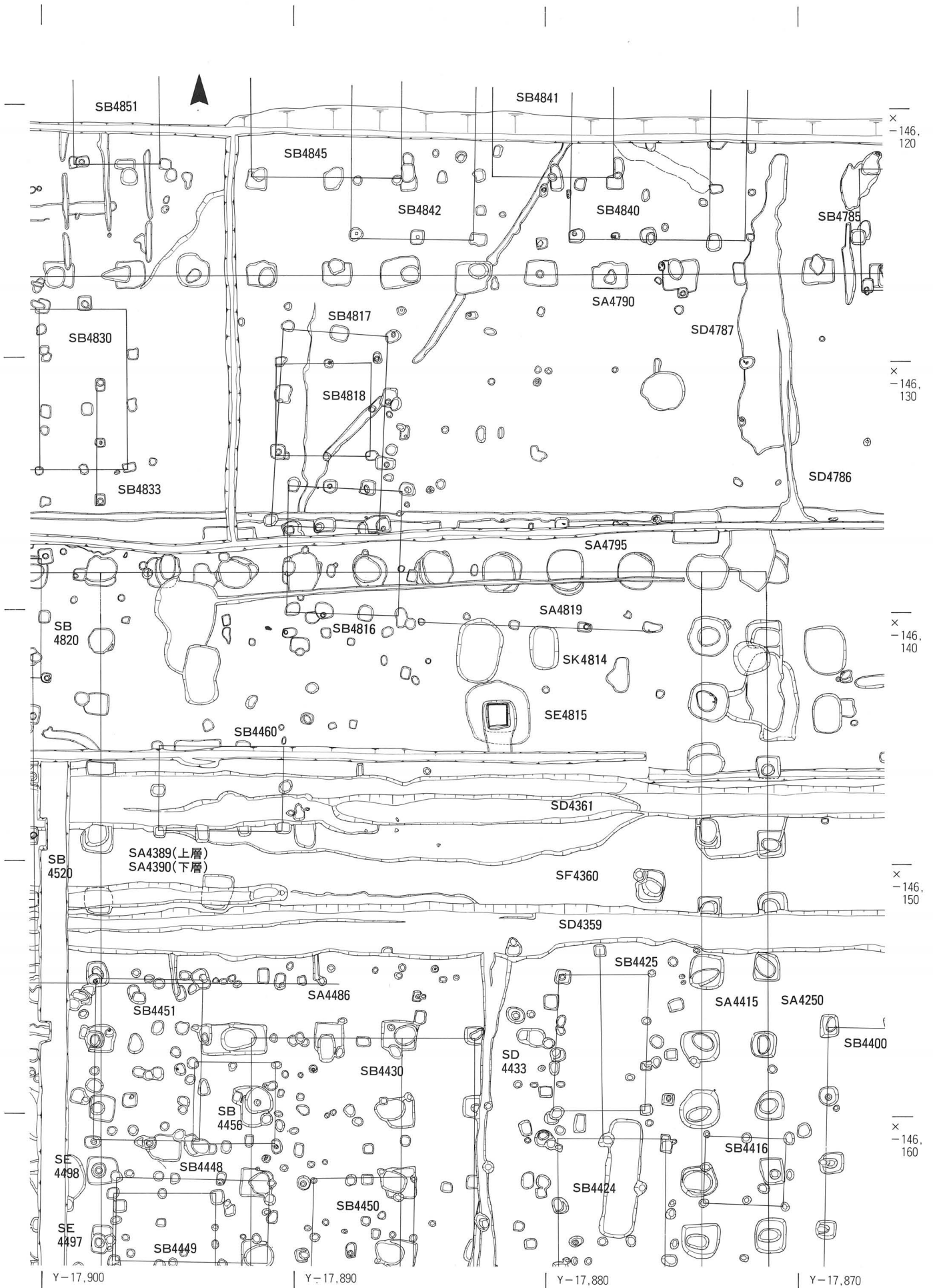

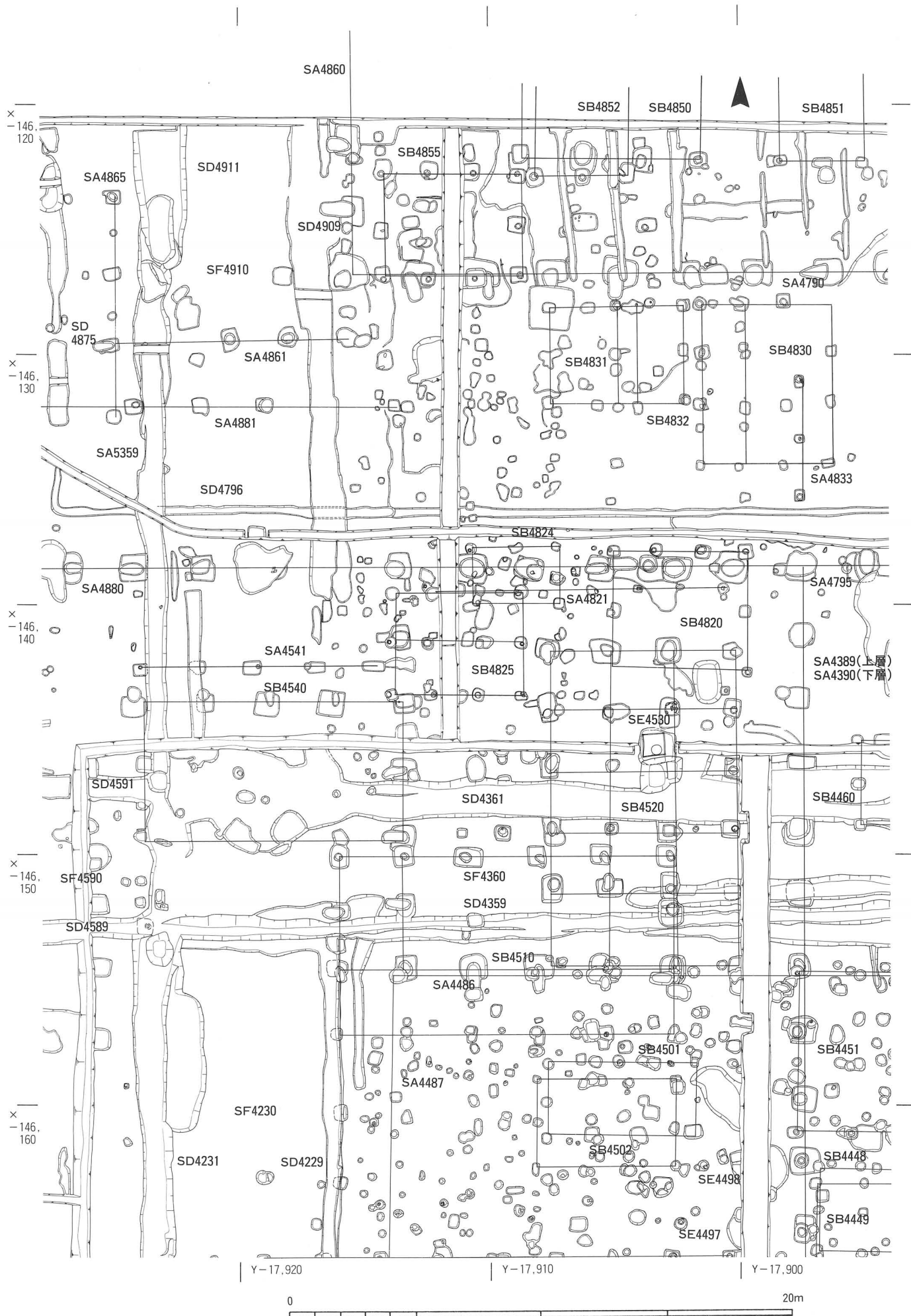

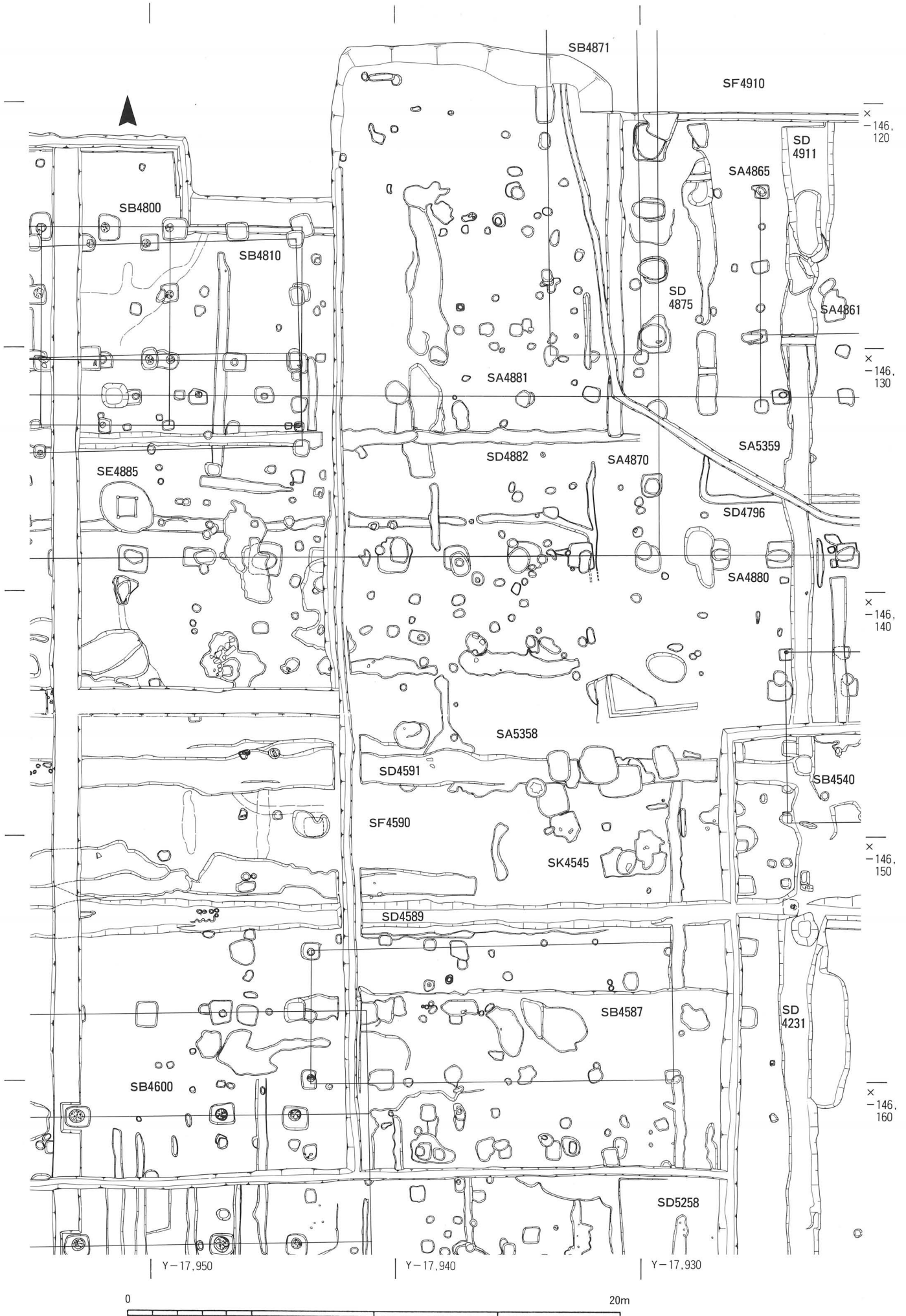

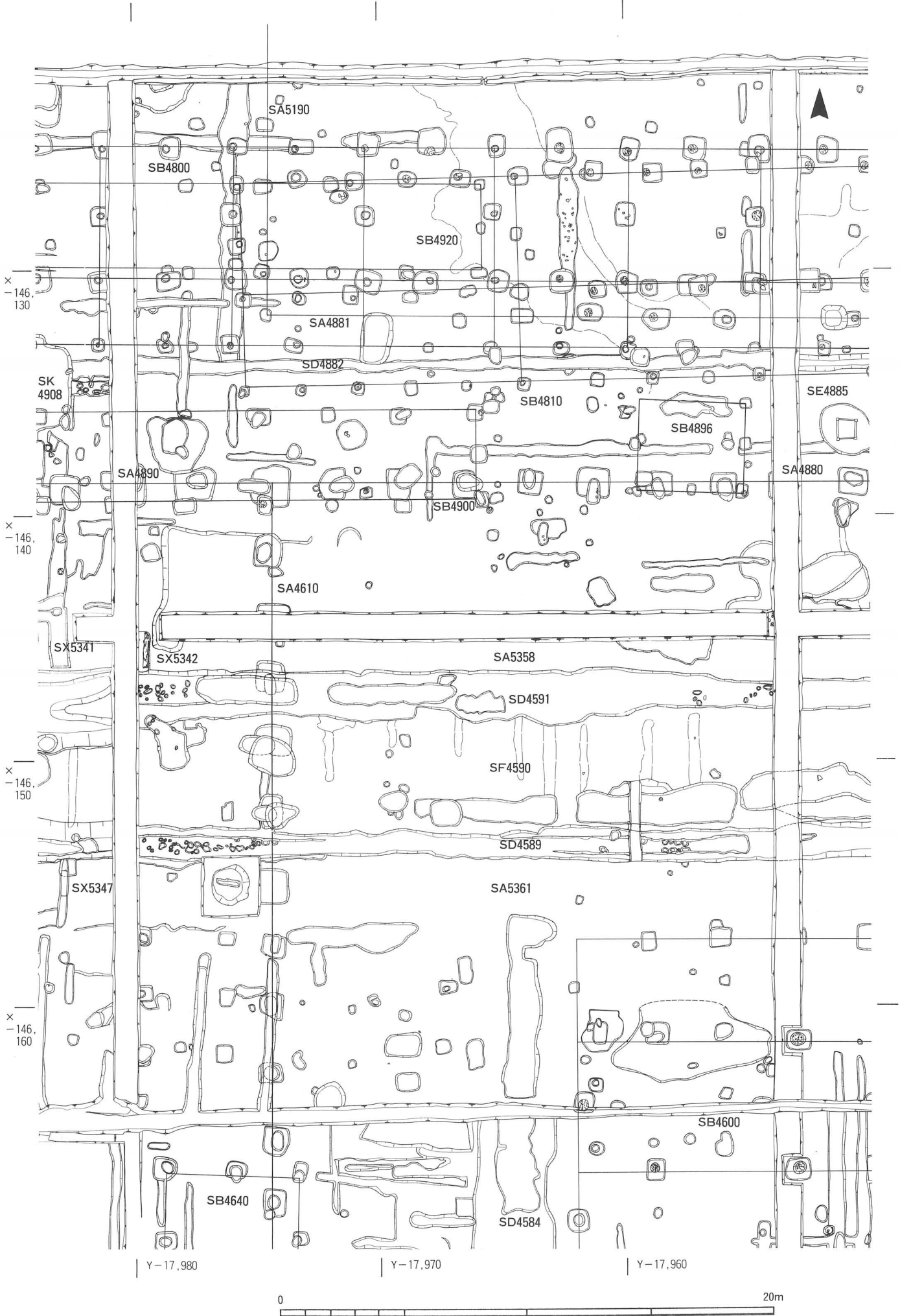

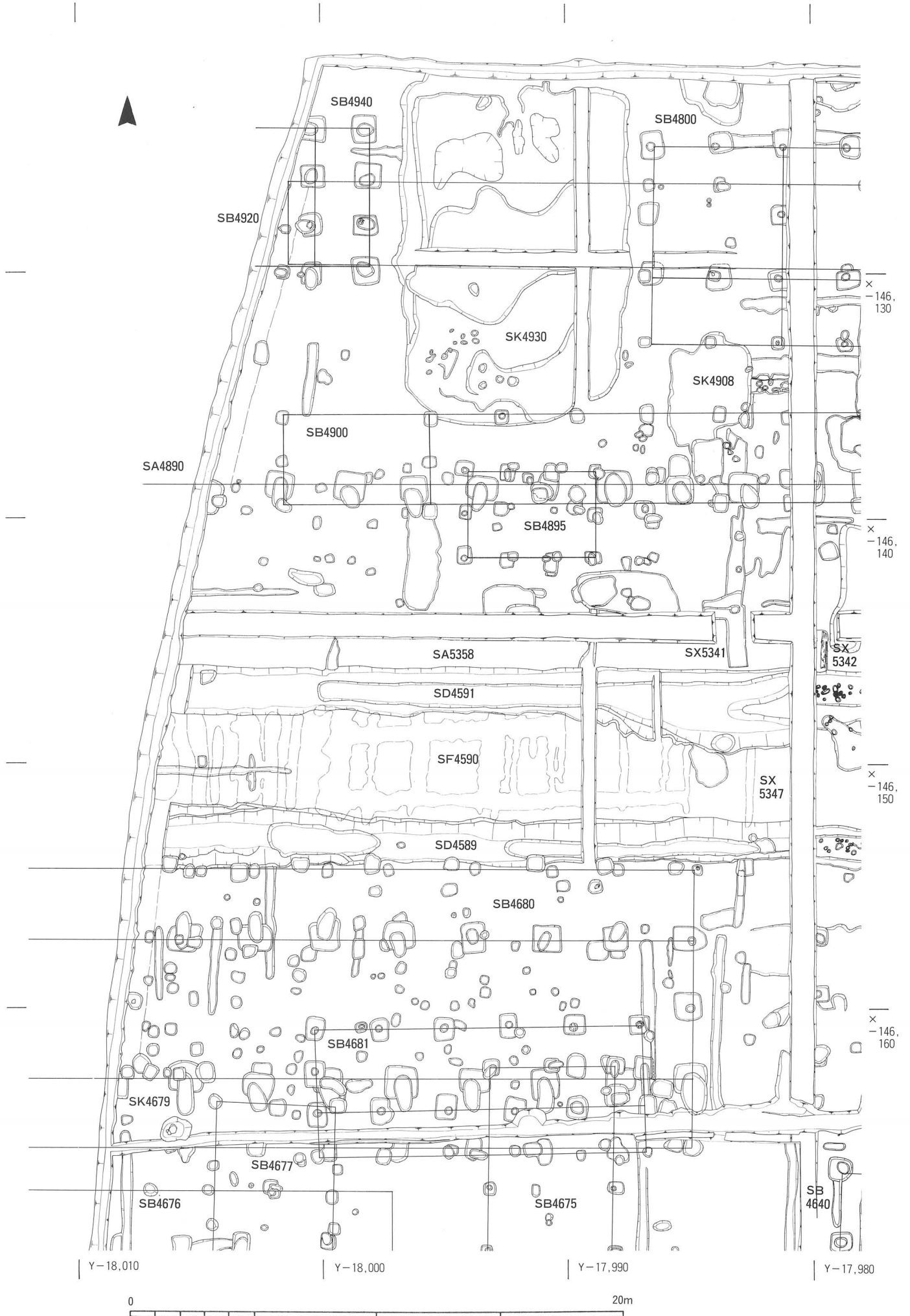

×
-146,
080

×
-146,
090

×
-146,
100

×
-146,
110

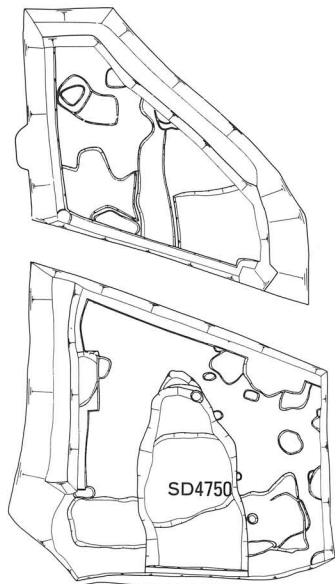
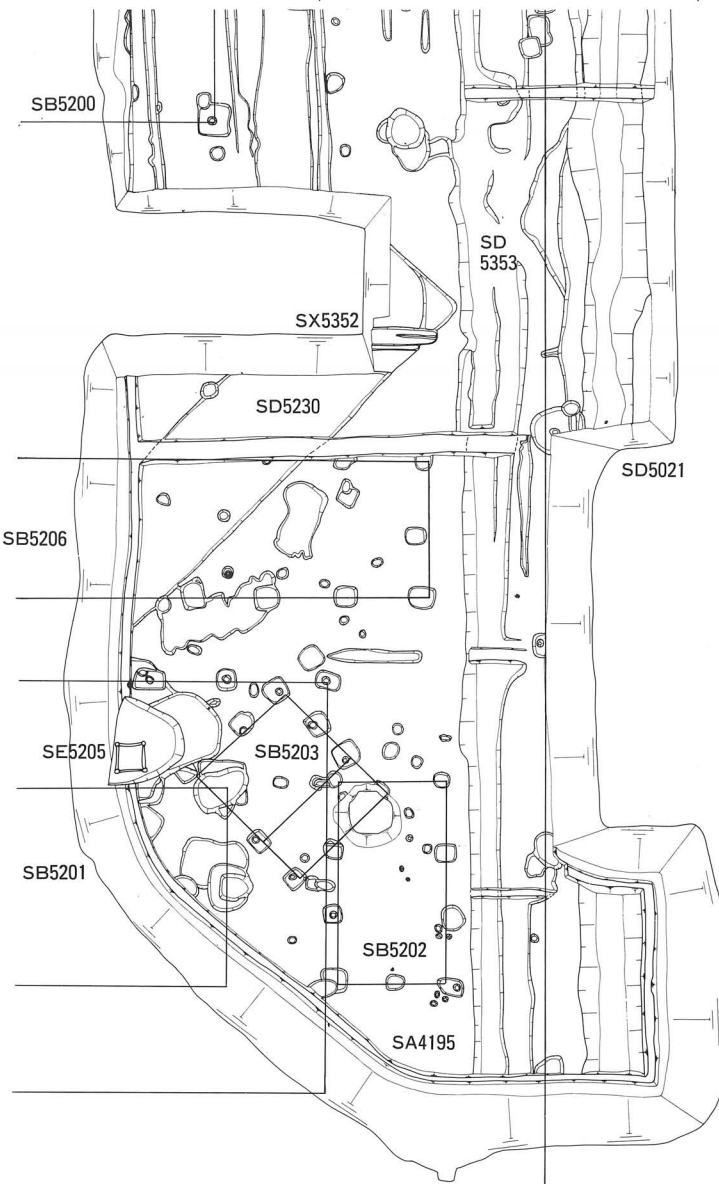

Y-17,810

Y-17,800

Y-17,790

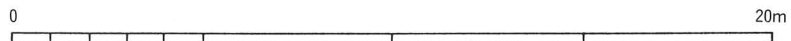

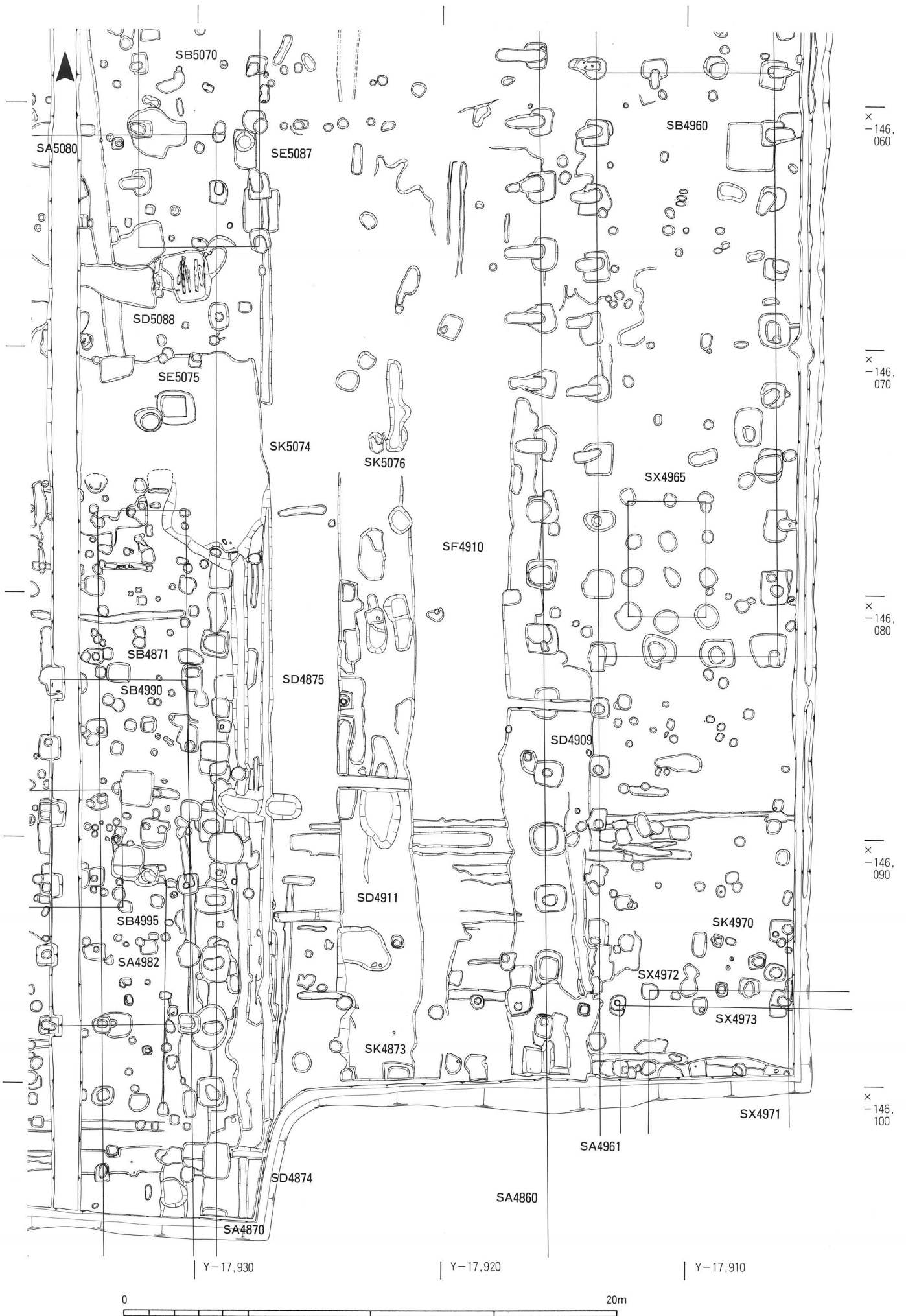

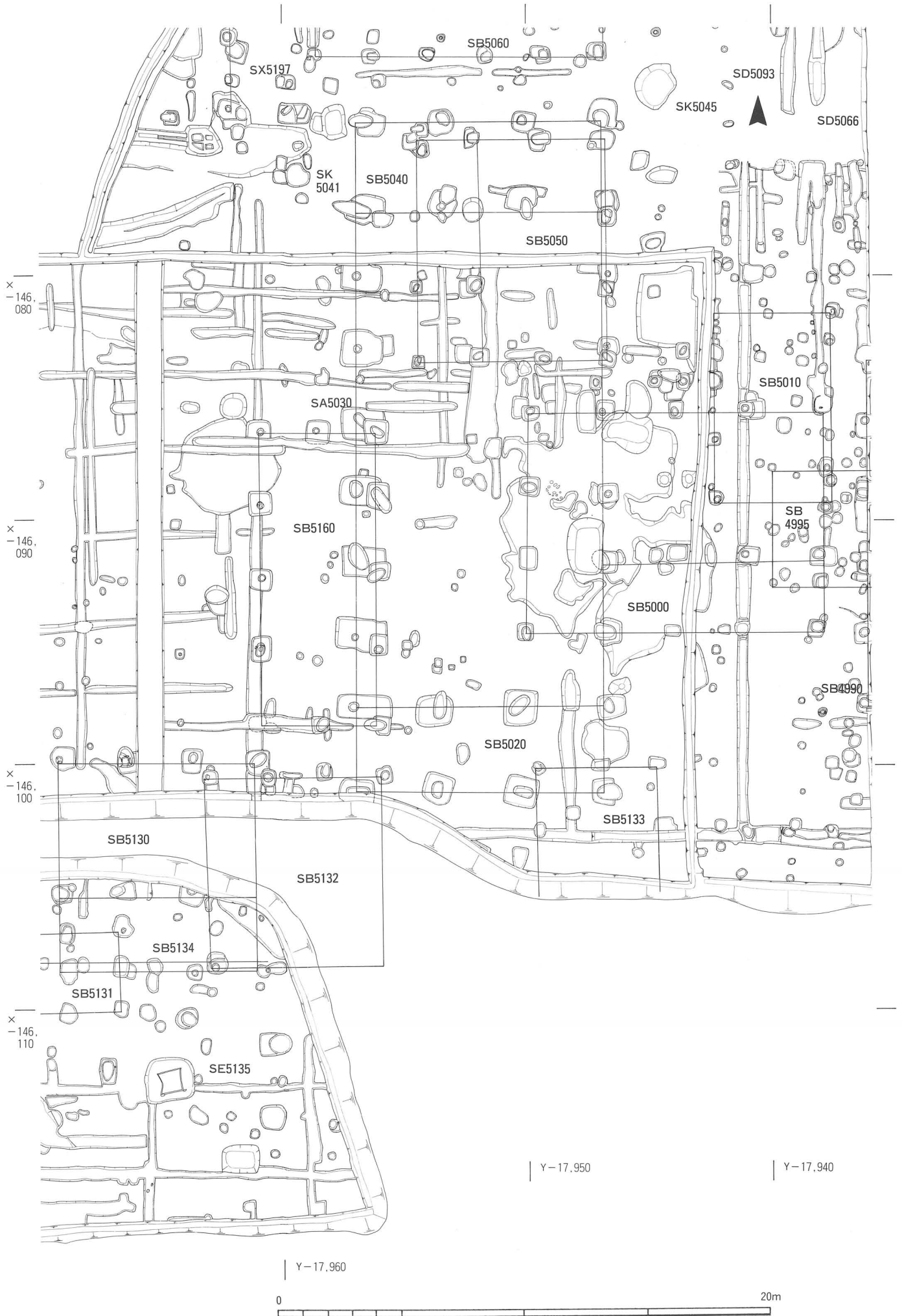

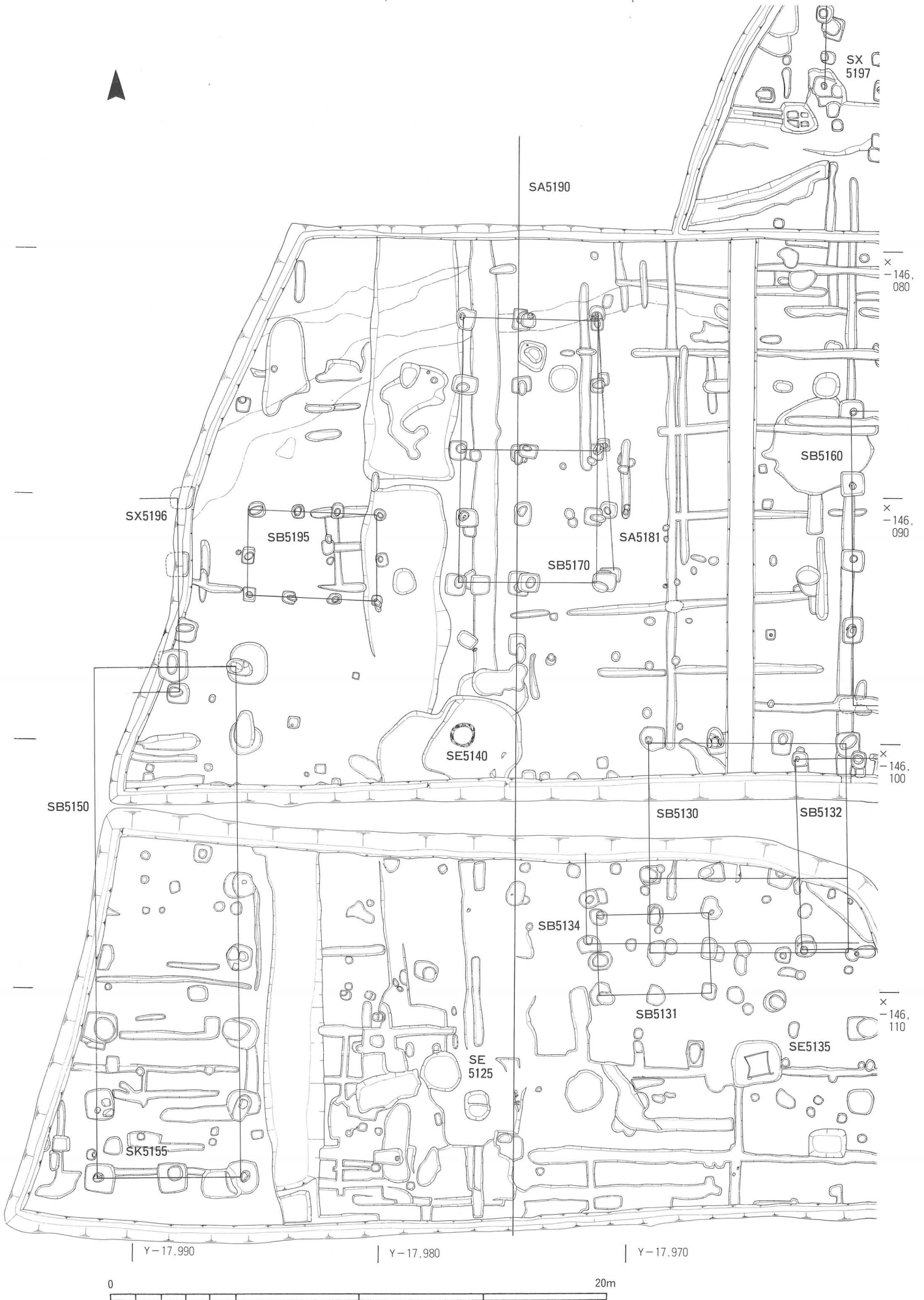

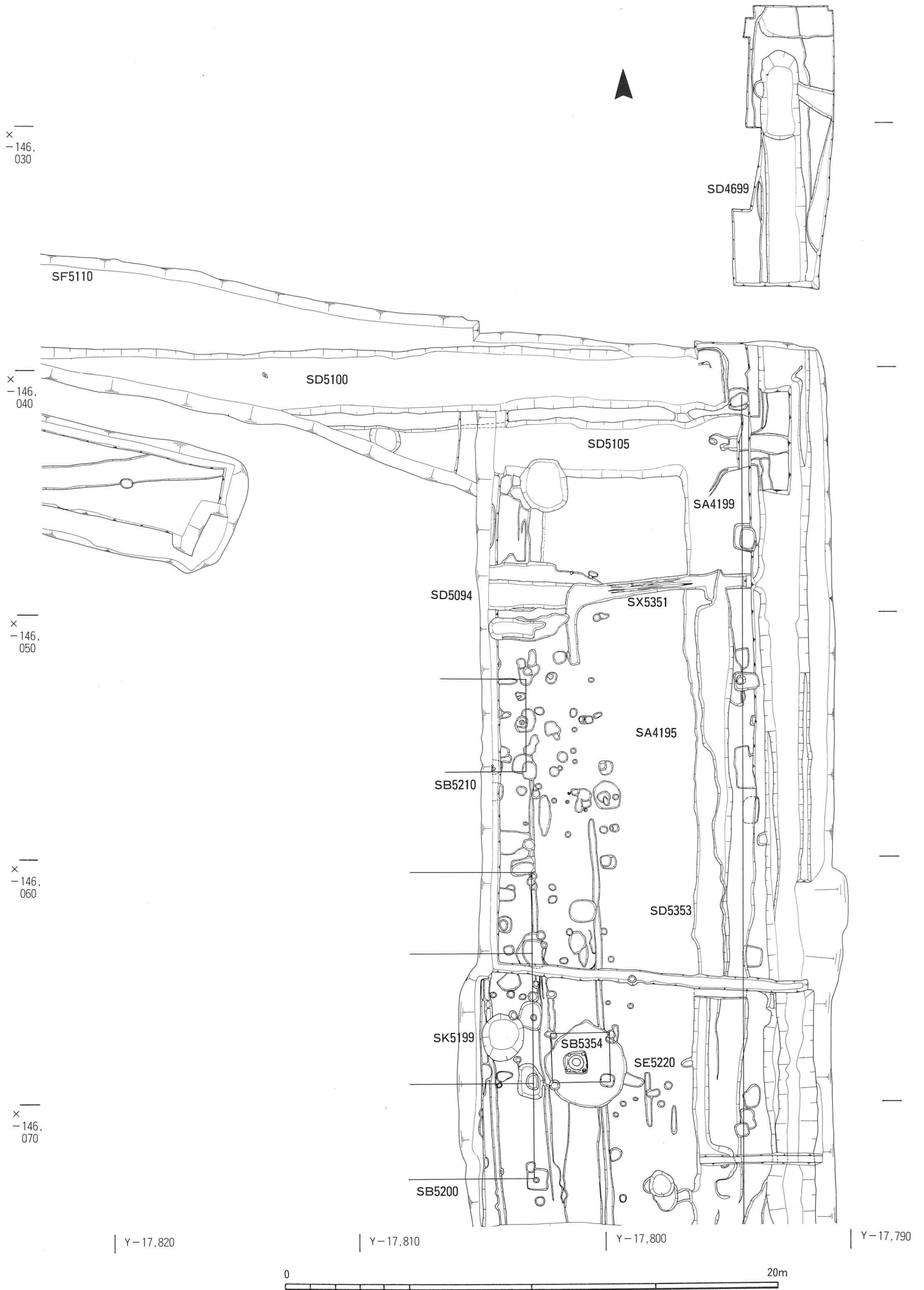

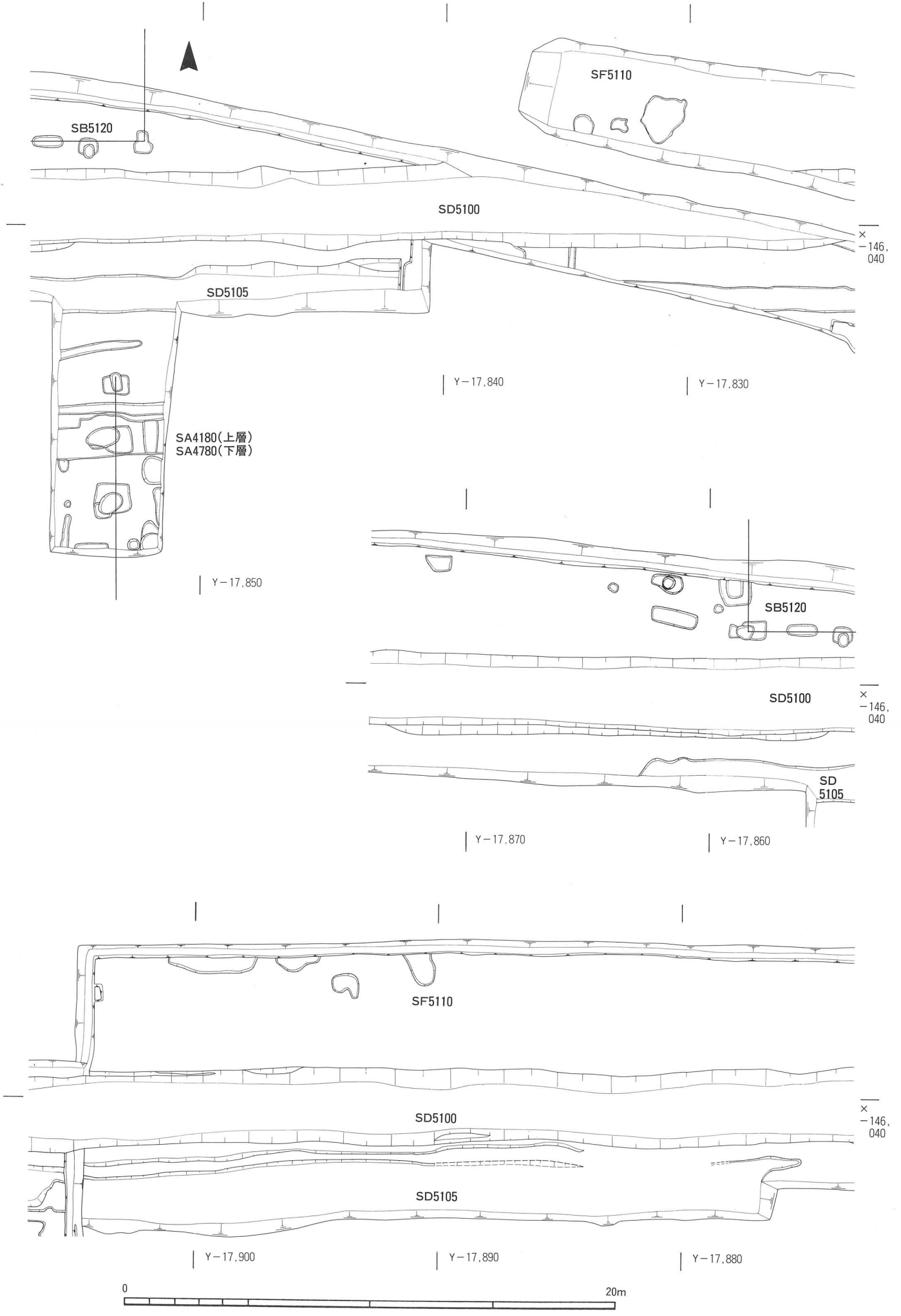

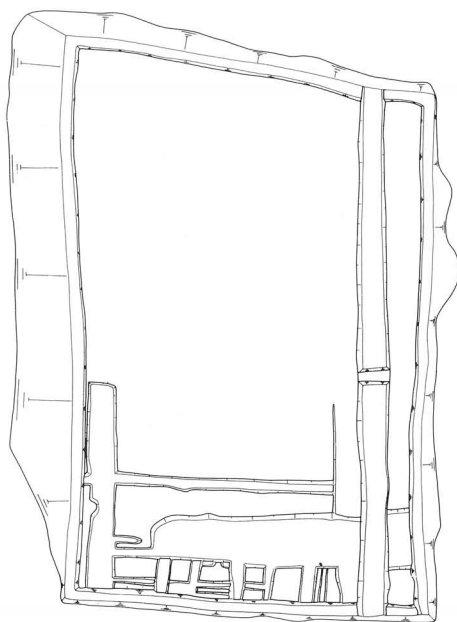

x
-146.
020

x
-146.
030

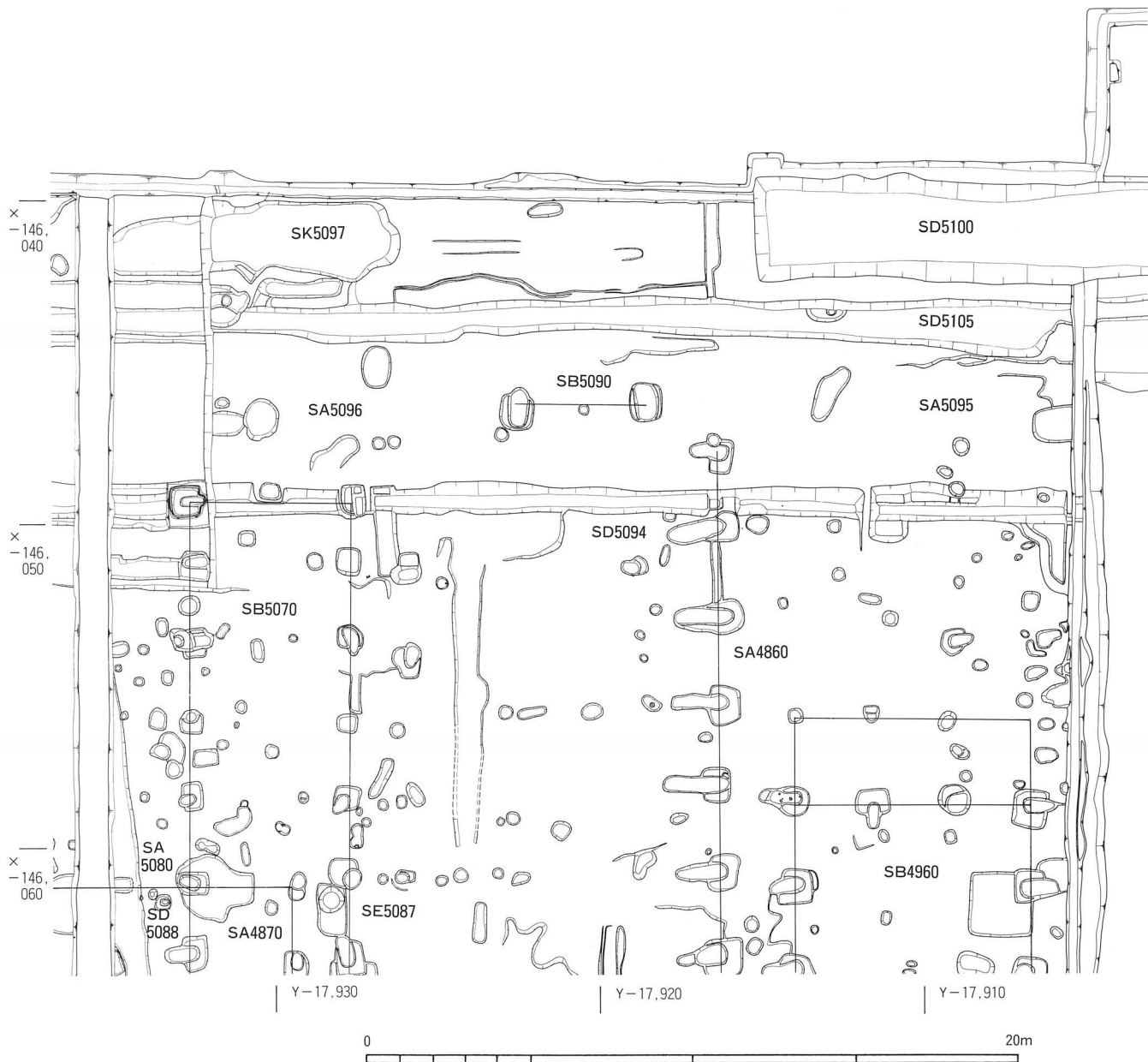

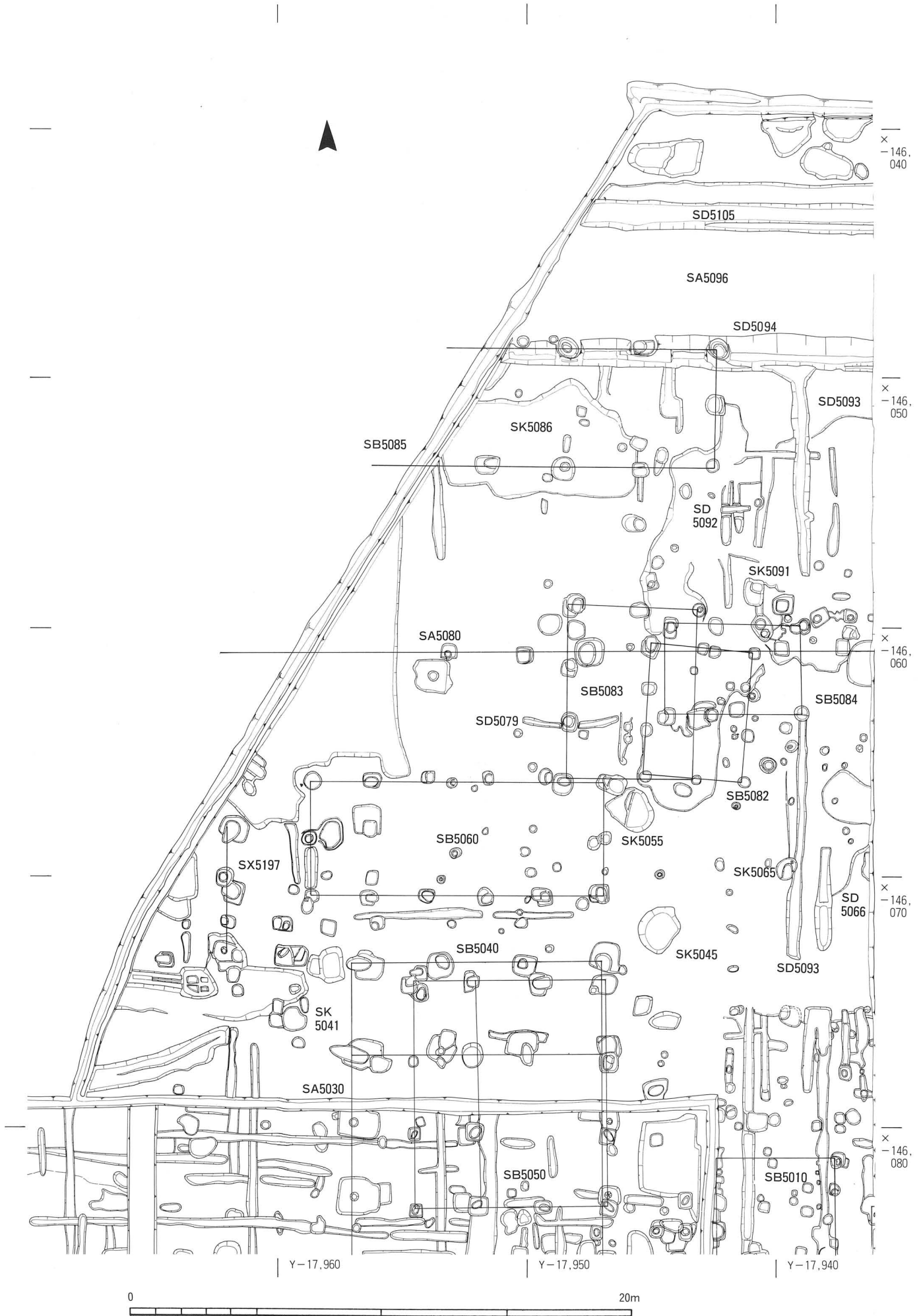

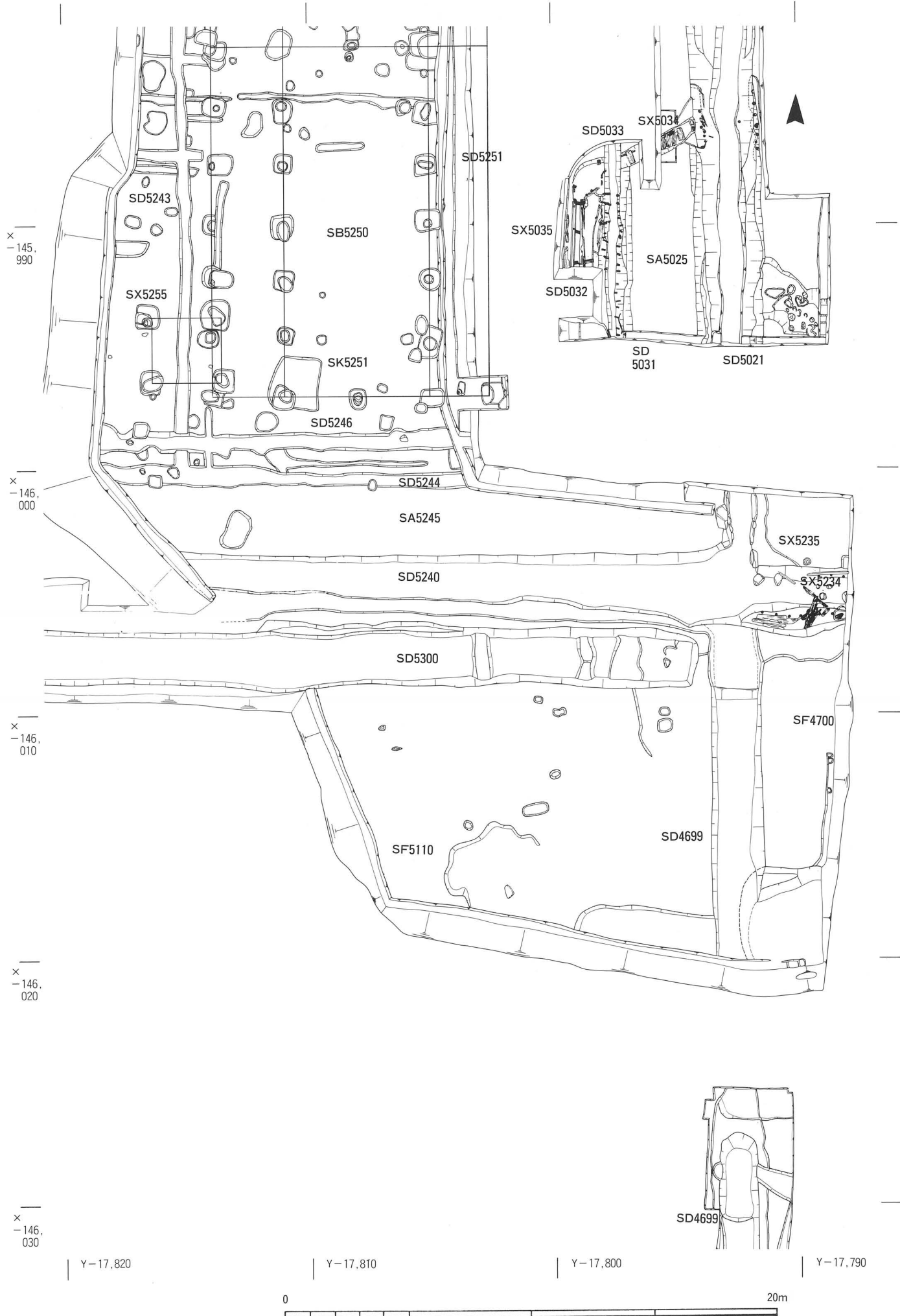

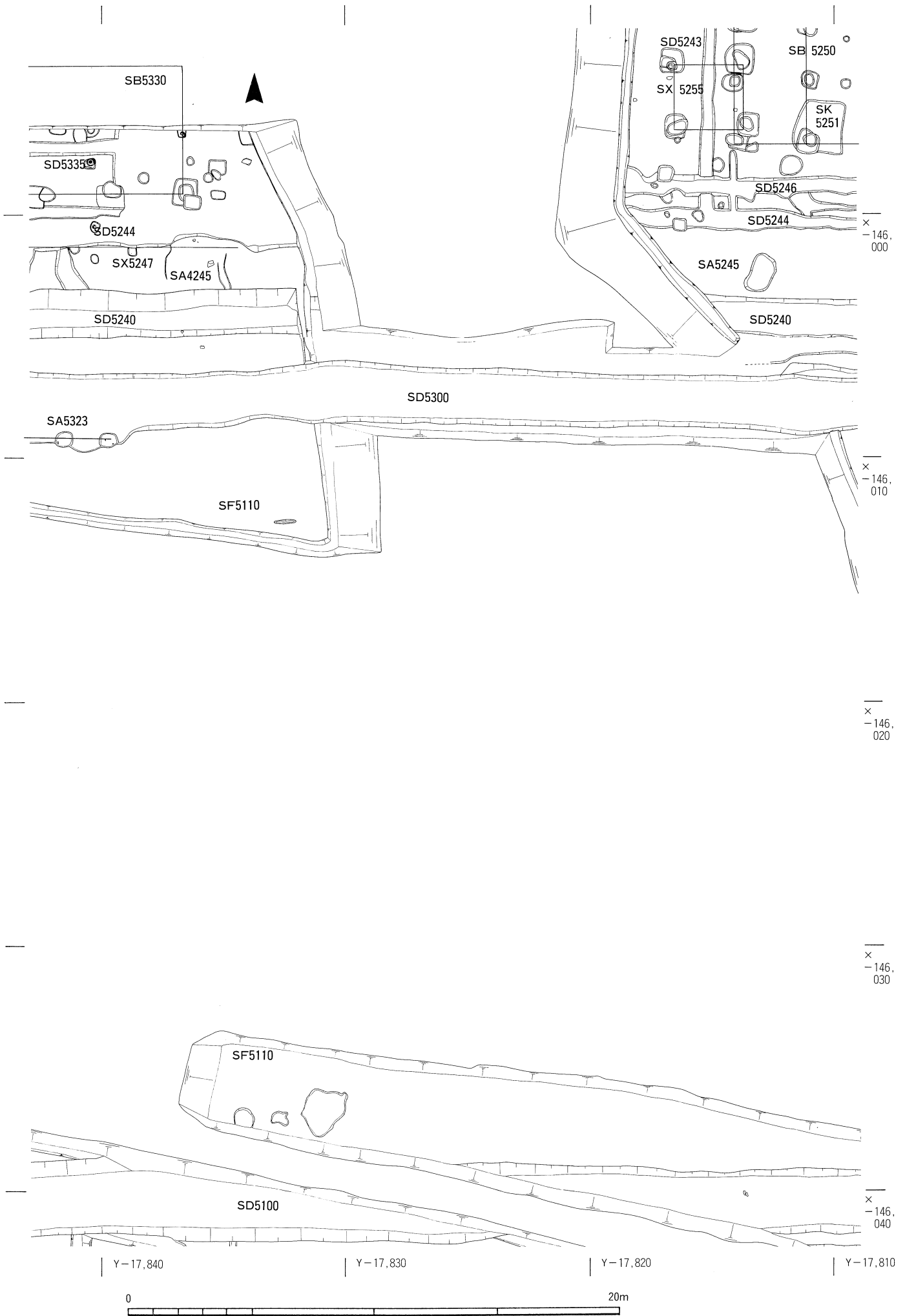

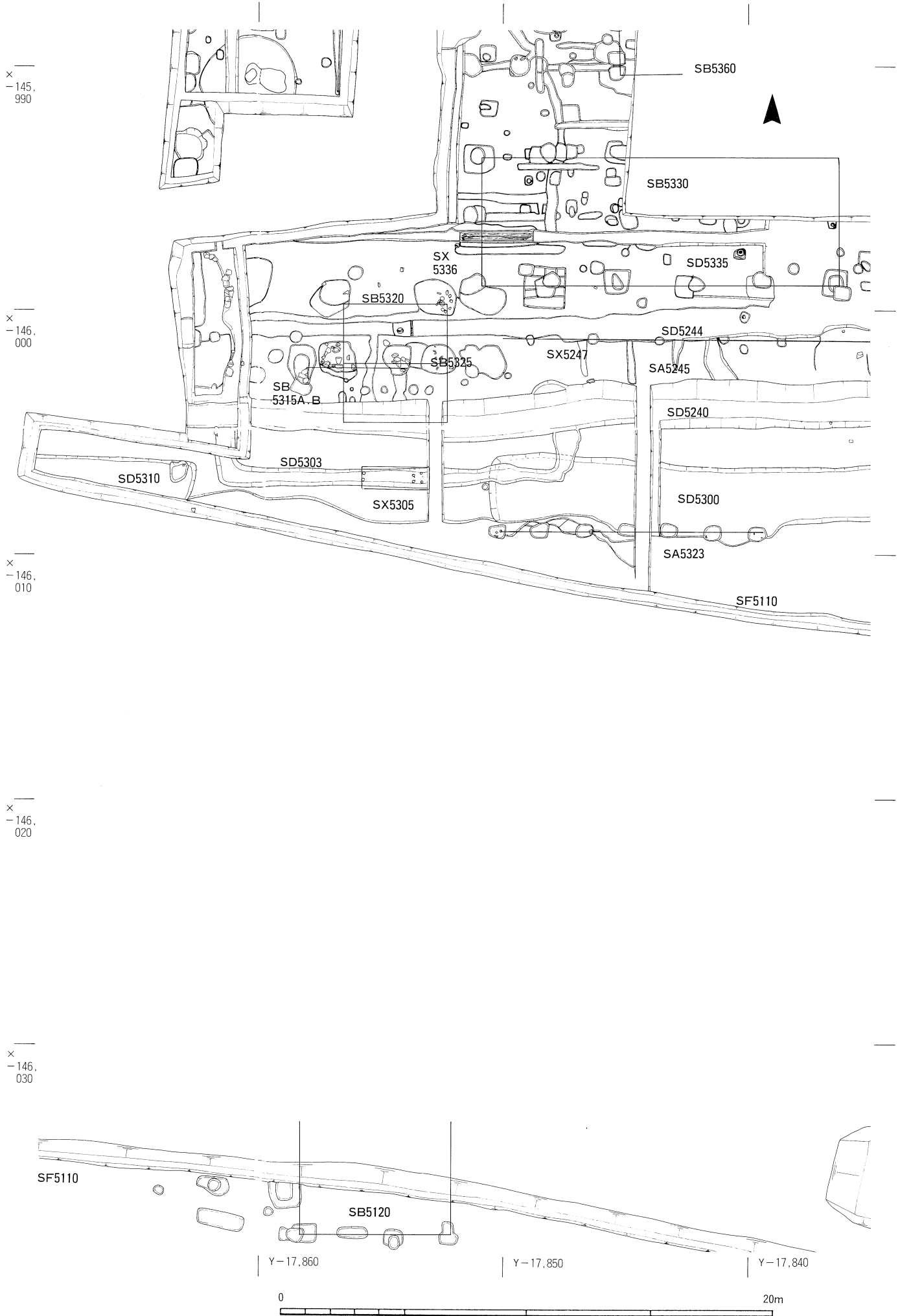

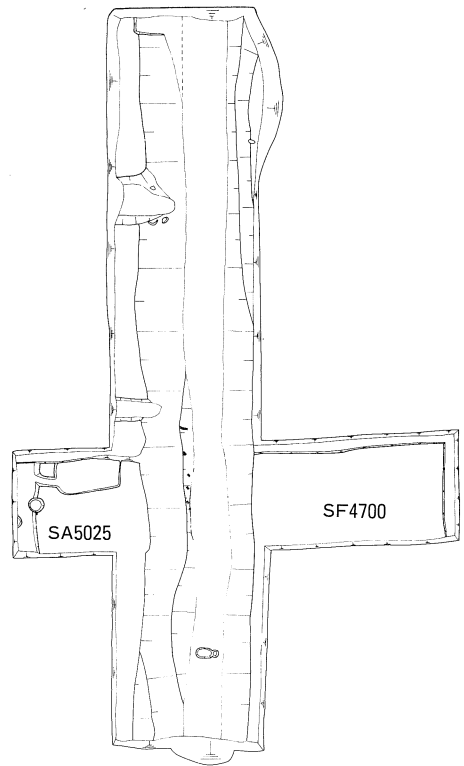
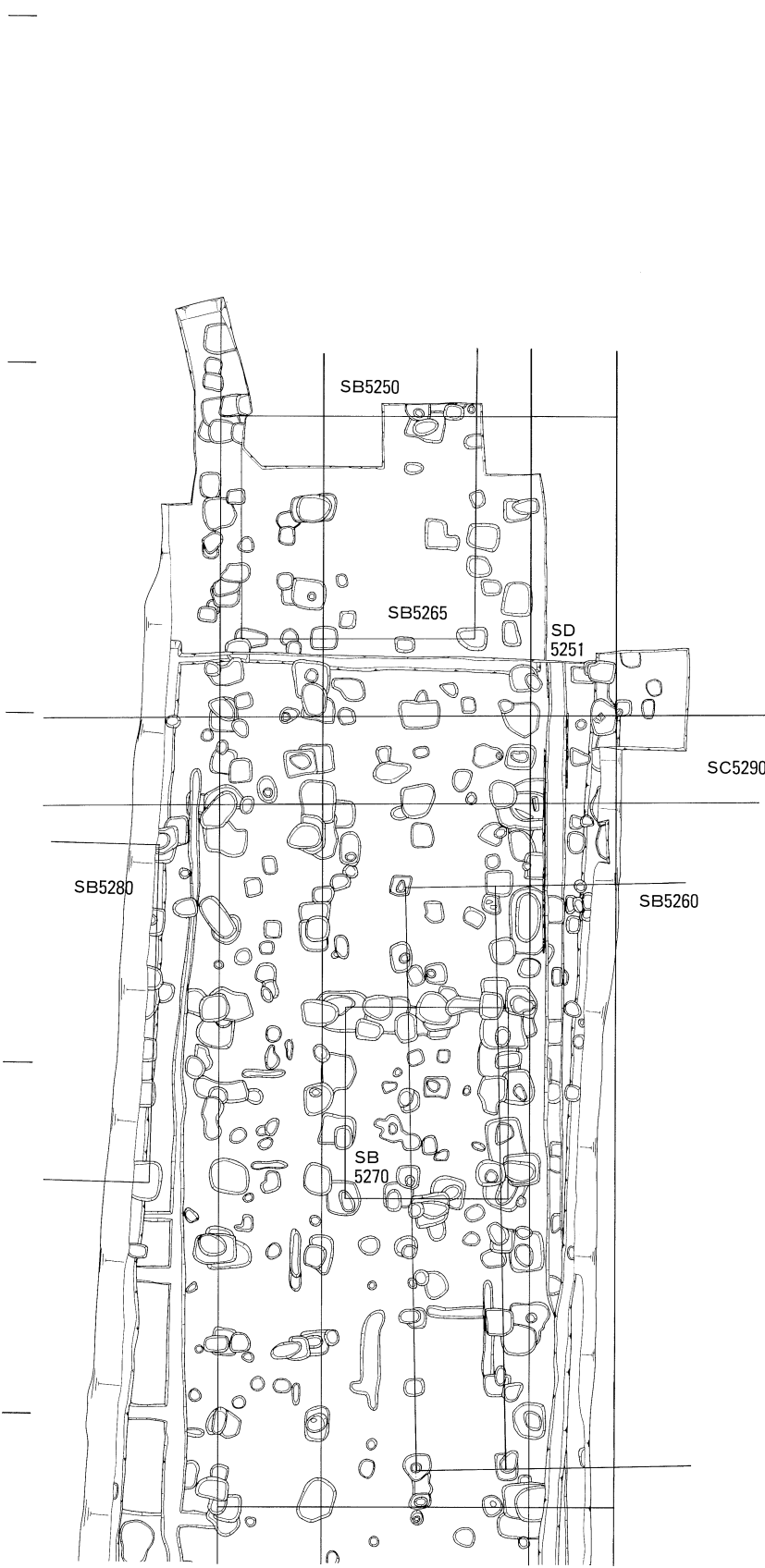

x
-145.
940

x
-145.
950

x
-145.
960

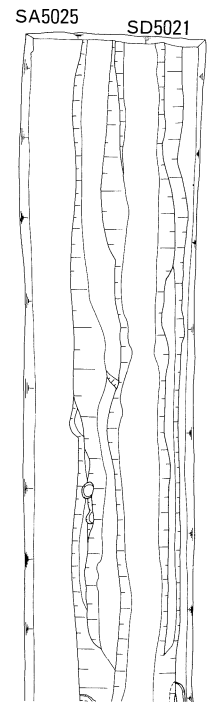

x
-145.
970

x
-145.
980

Y-17.810

Y-17.800

Y-17.790

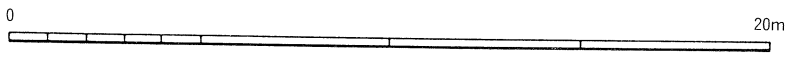

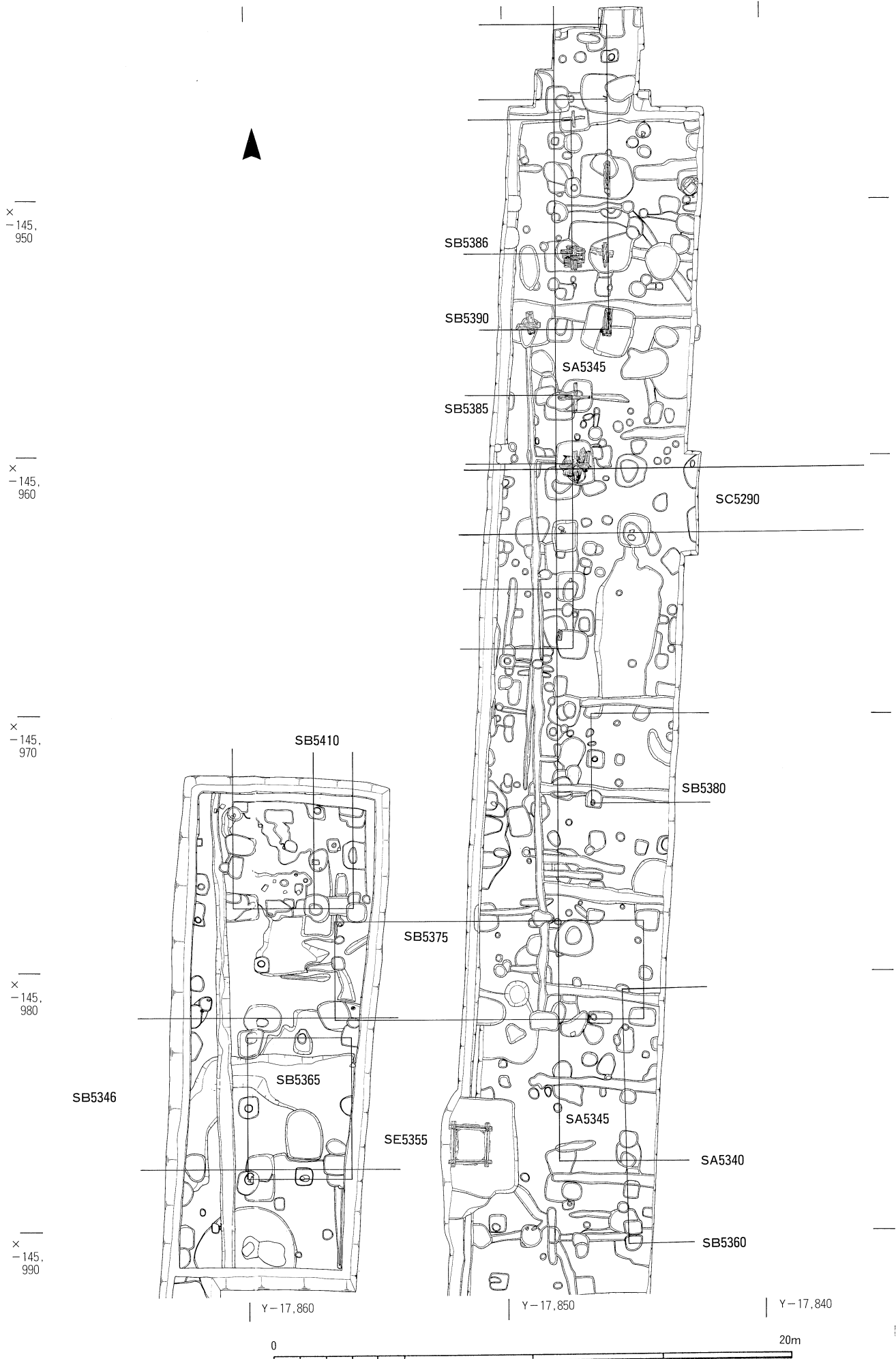

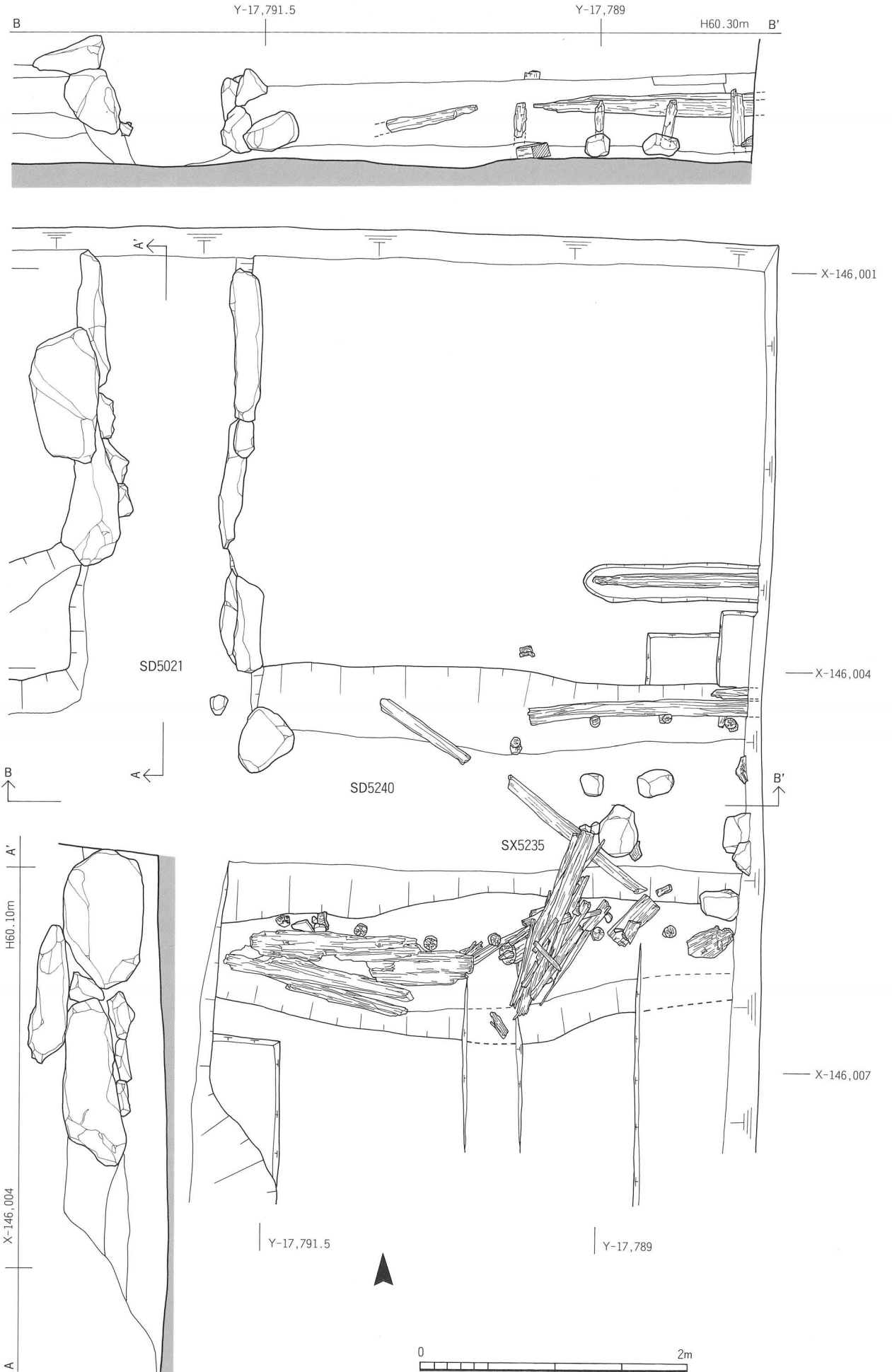

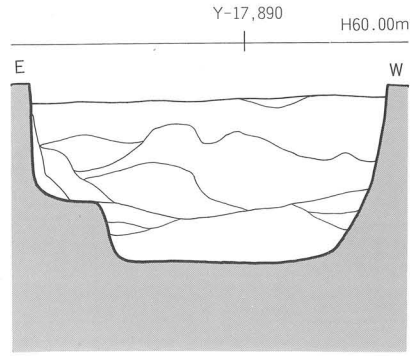
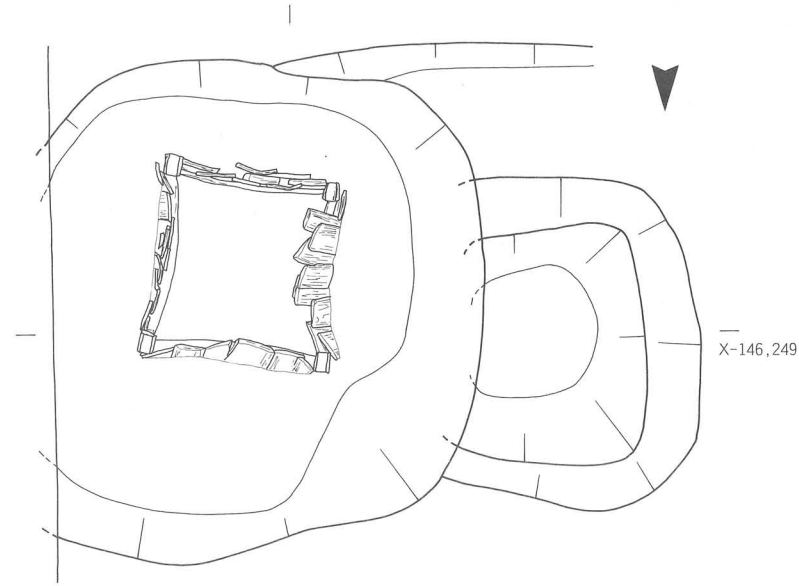

3 SE4209

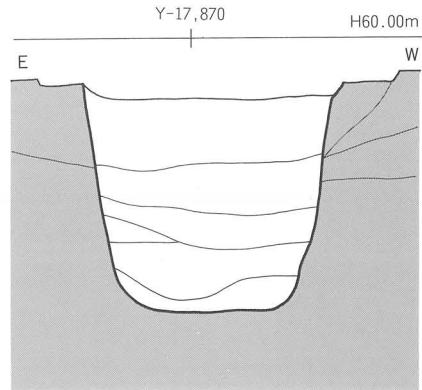

4 SE4211

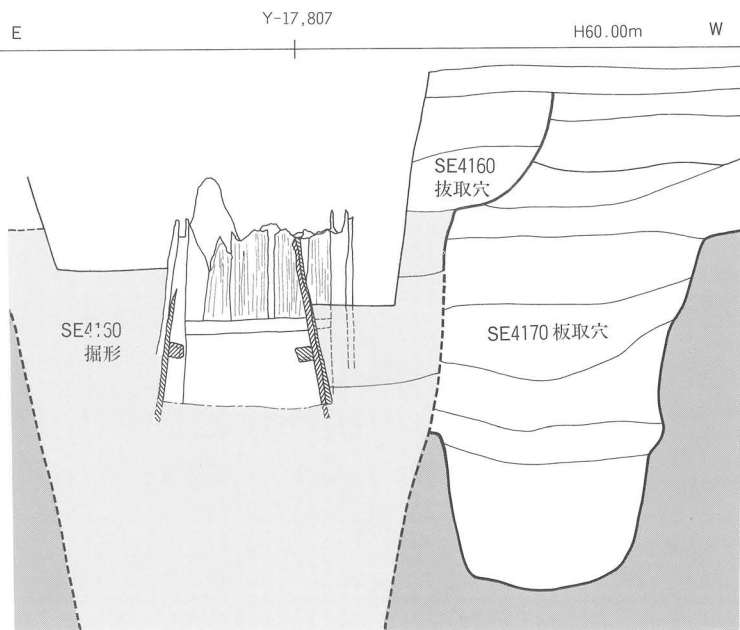

1 SE4116(左)・4117(右)

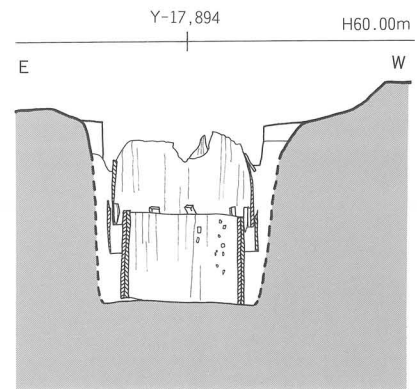
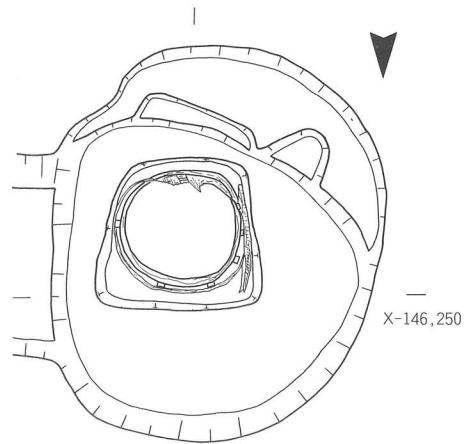

5 SE4217

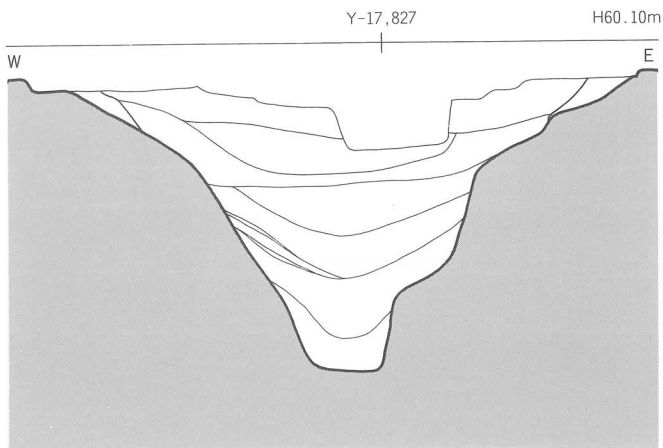
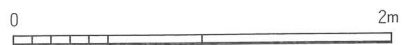

2 SE4160



1・3~5 1:40 2 1:50

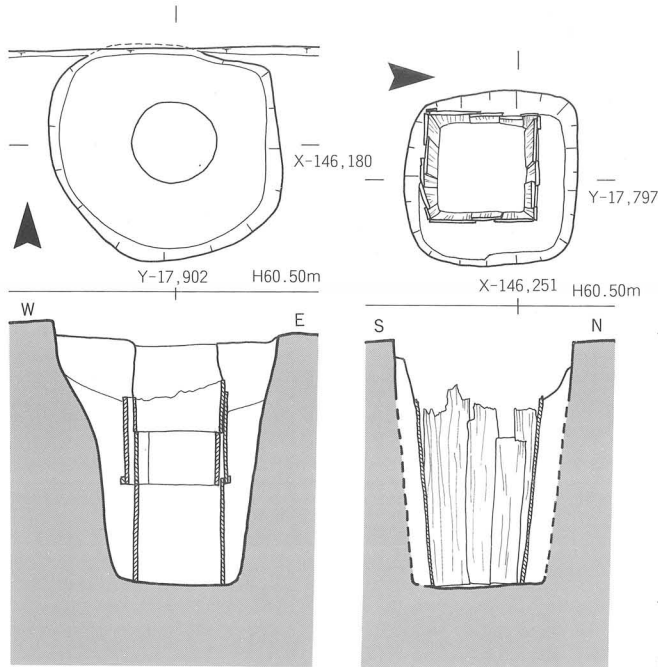

1 SE4225

2 SE4218

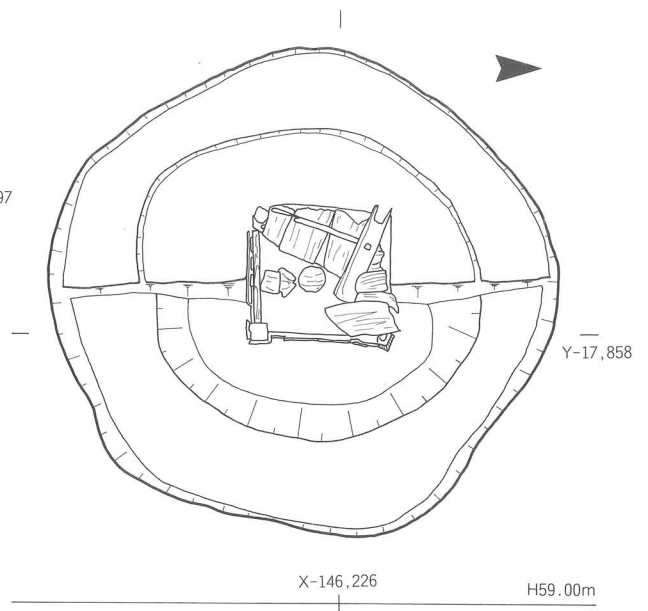

3 SE4185

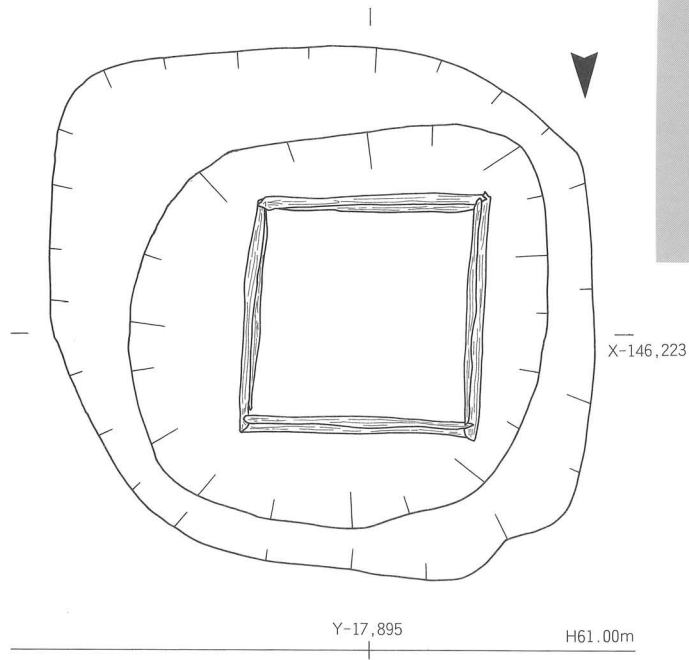

4 SE4268

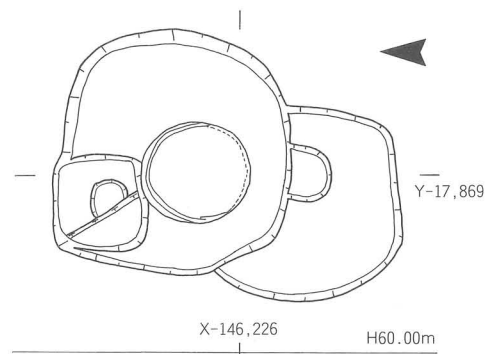

5 SE4265

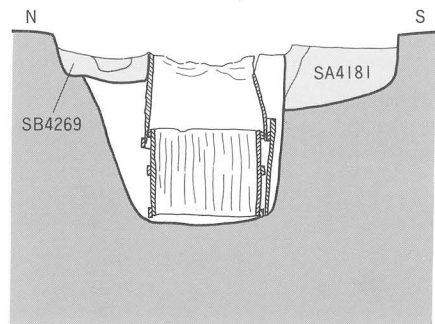

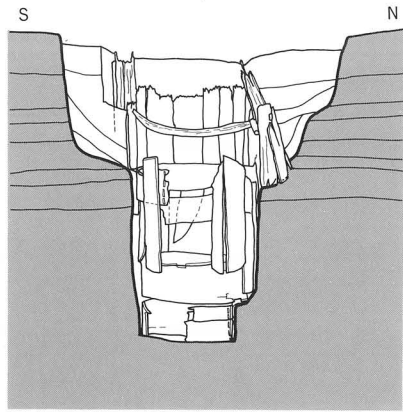
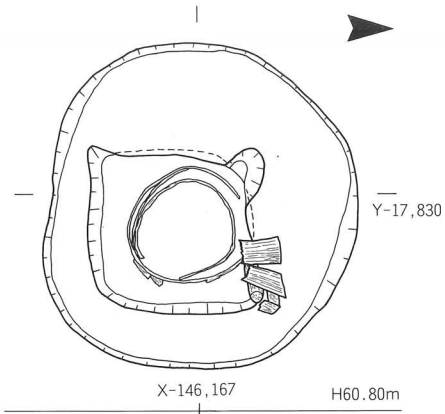

1 SE4340

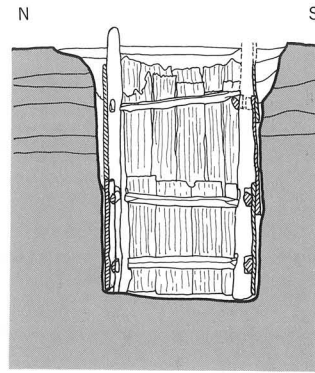
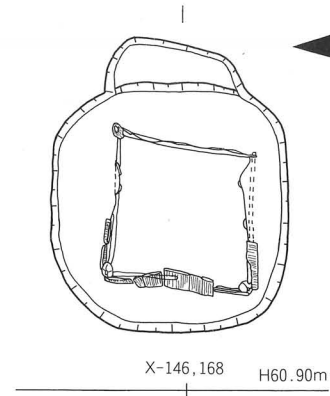

3 SE4380

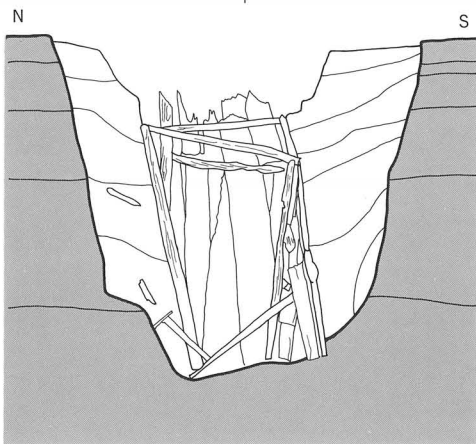
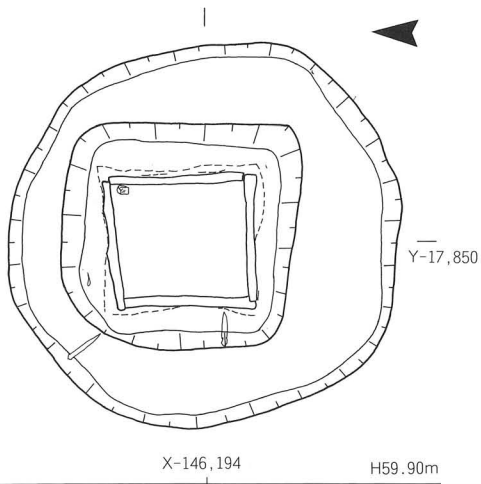

2 SE4365

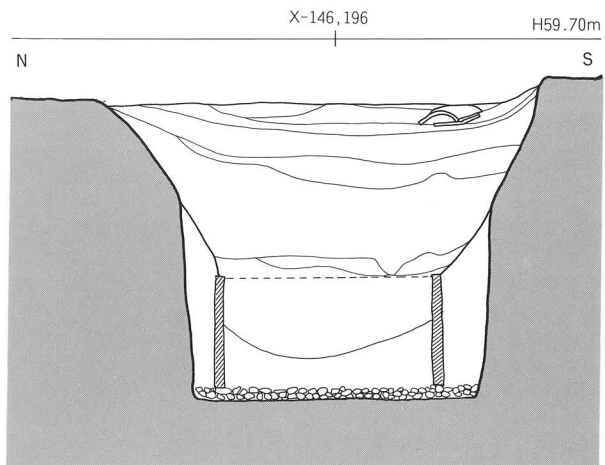
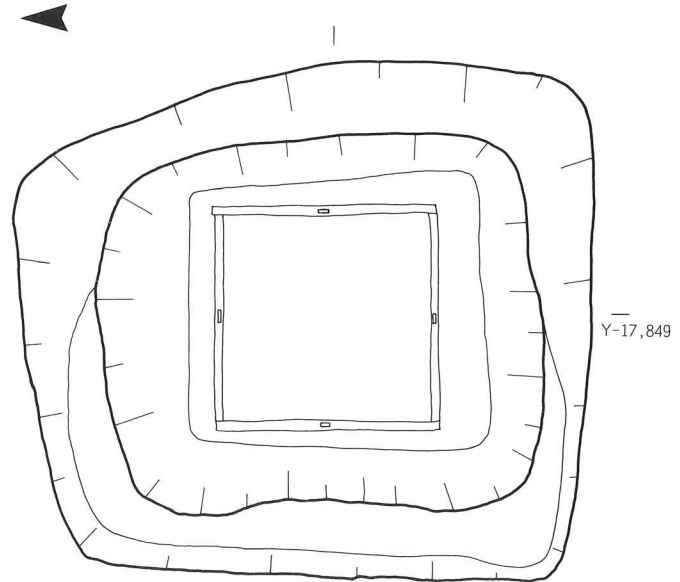

4 SE4366



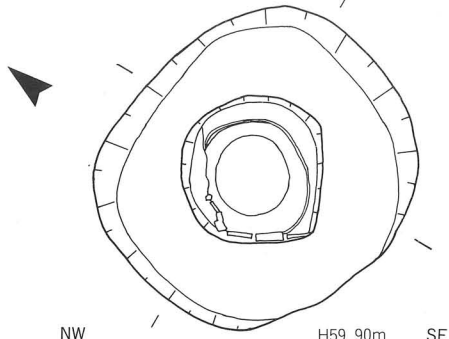

NW H59.90m SE

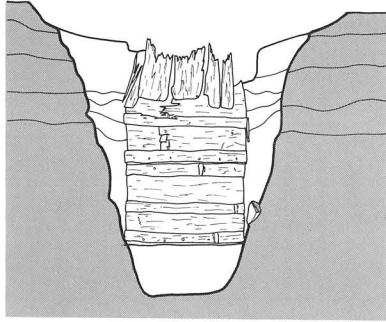

1 SE4405

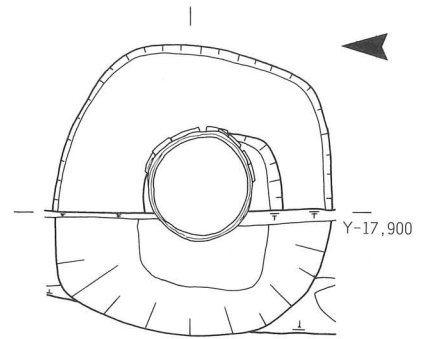

N X-146,165 H60.20m W

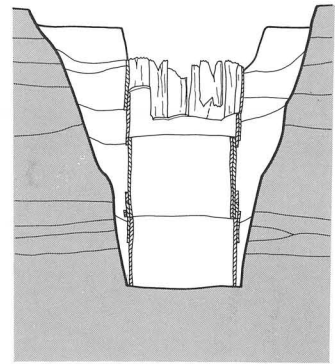

3 SE4497

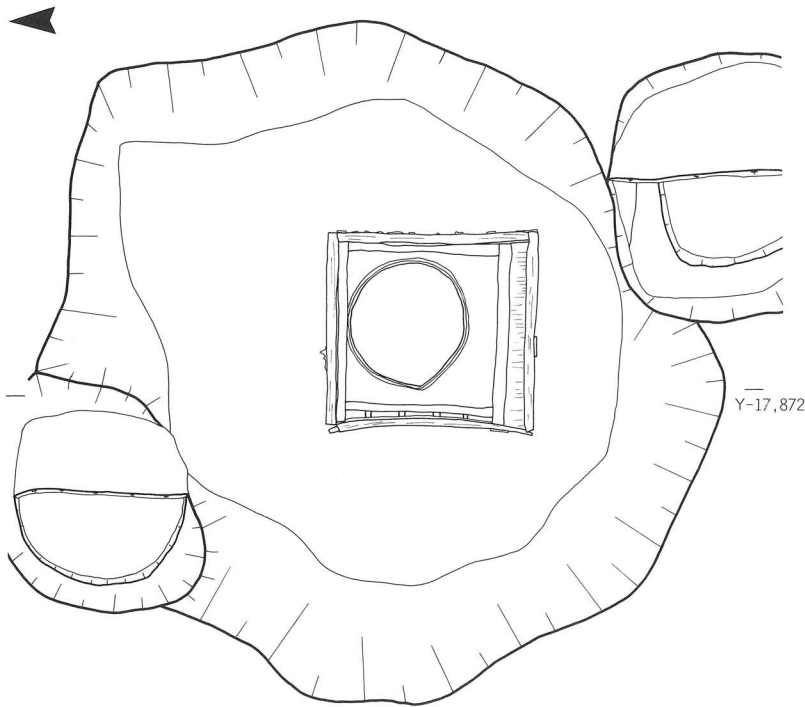

X-146,199 H59.90m

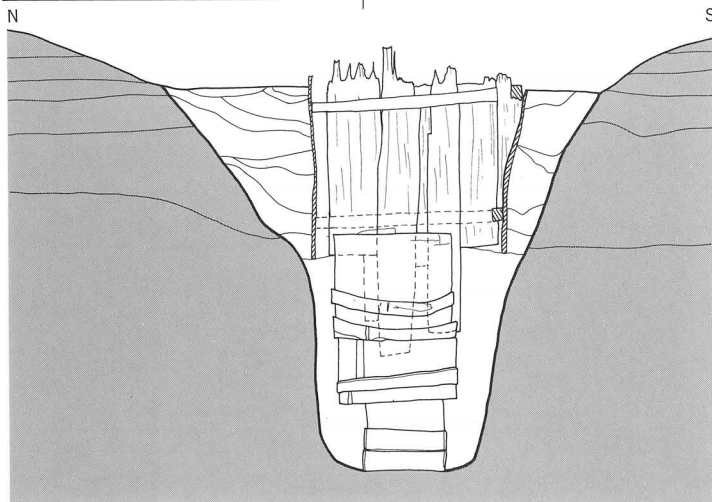

2 SE4395

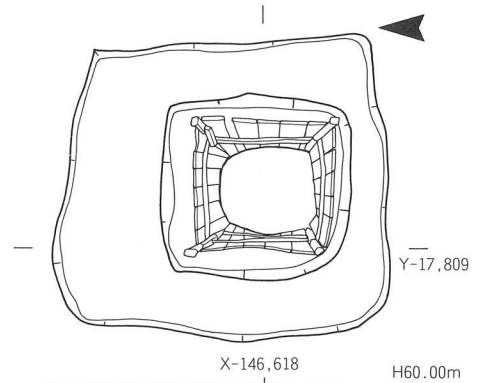

N X-146,618 H60.00m S

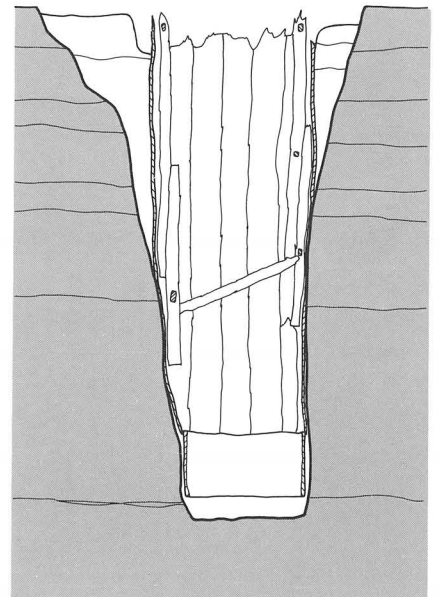

4 SE4720



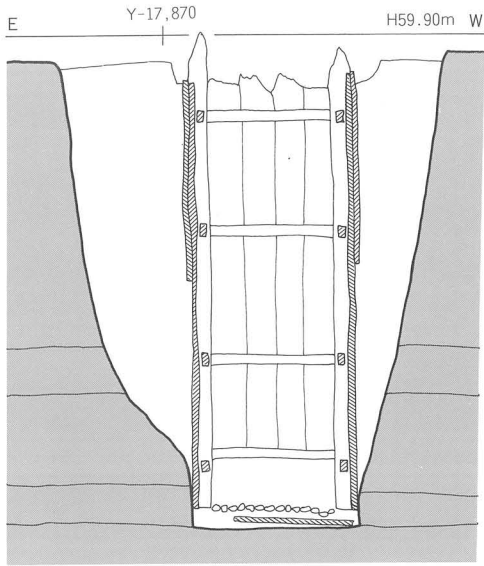

1 SE4760

S Y-146,125 H60.00m N

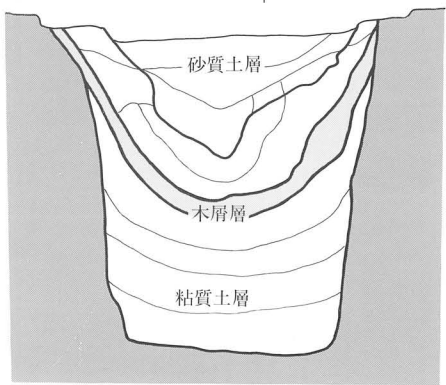

2 SE4770

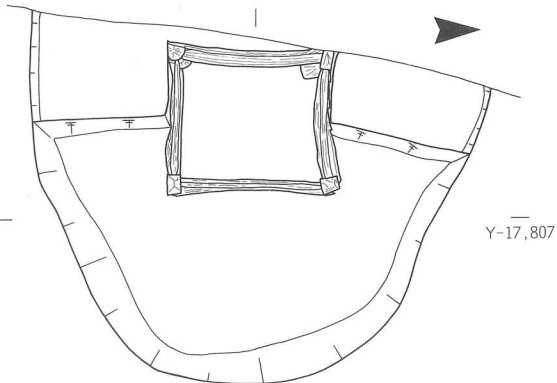

Y-17,807

X-146,092

H60.00m N

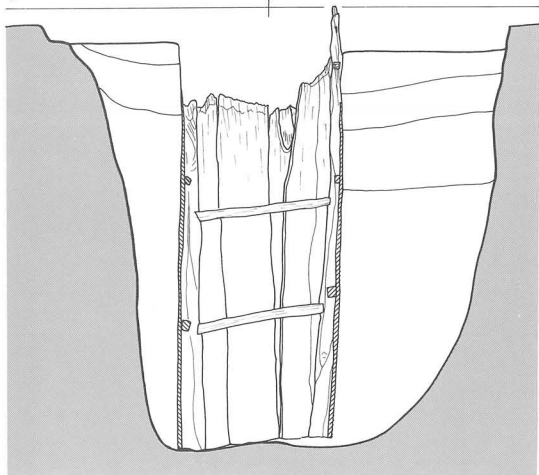

5 SE5205

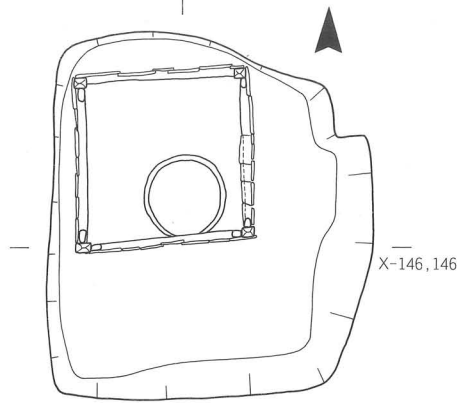

X-146,146

Y-17,903

H60.10m

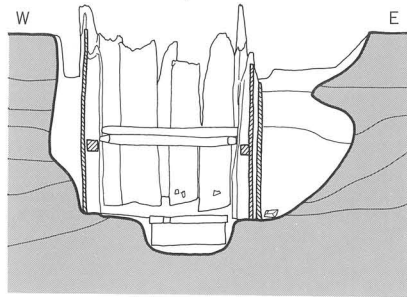

3 SE4530

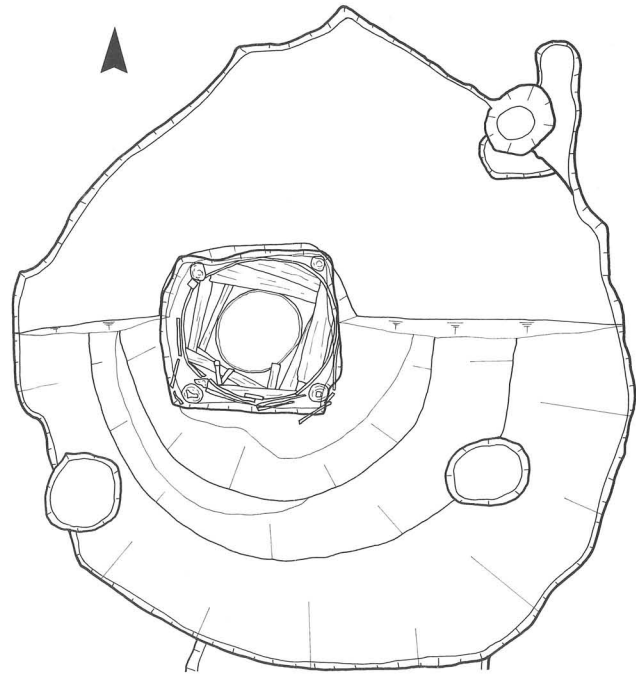

X-146,068

Y-17,804

H60.10m E

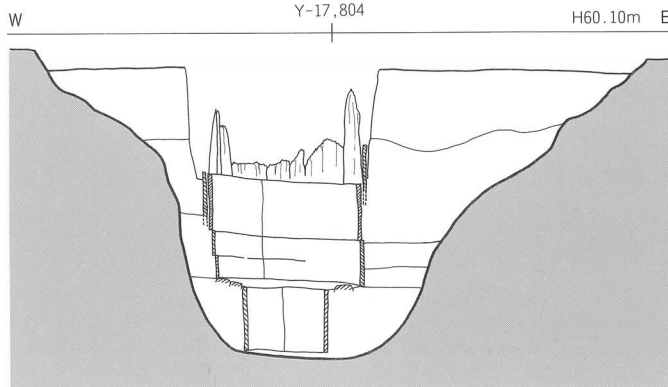

6 SE5220



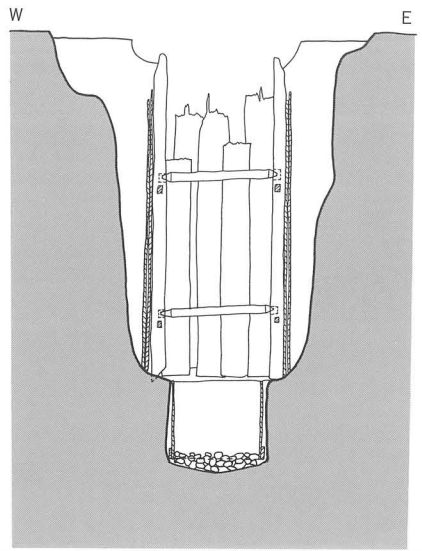
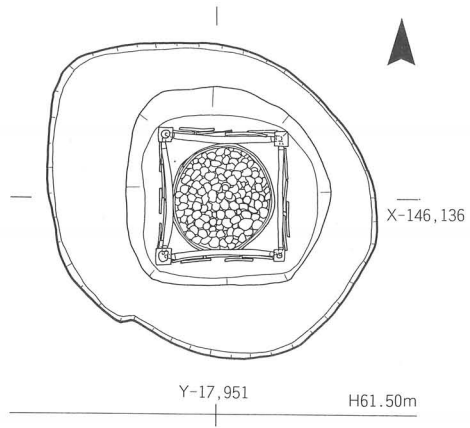

1 SE4885

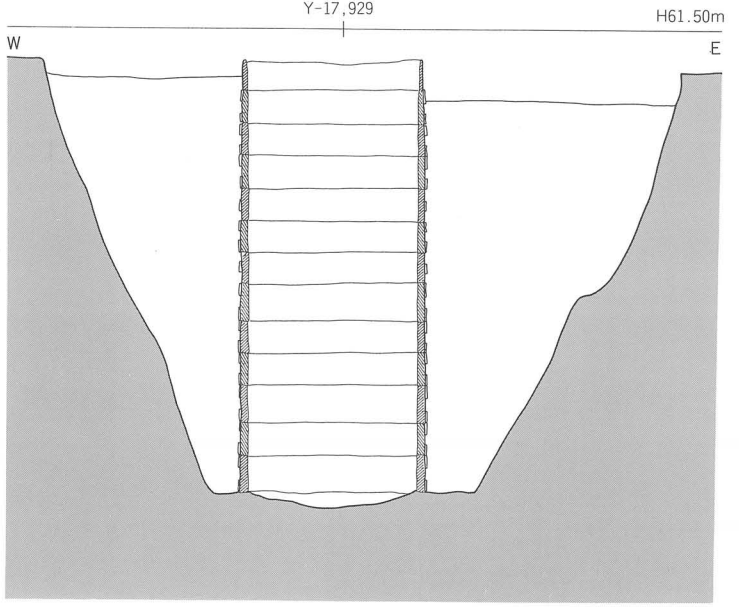
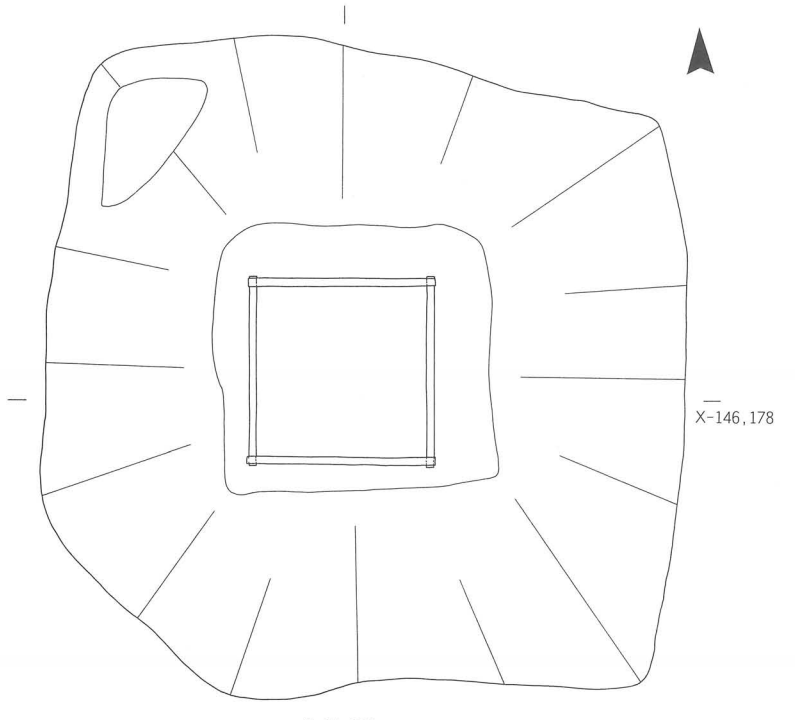
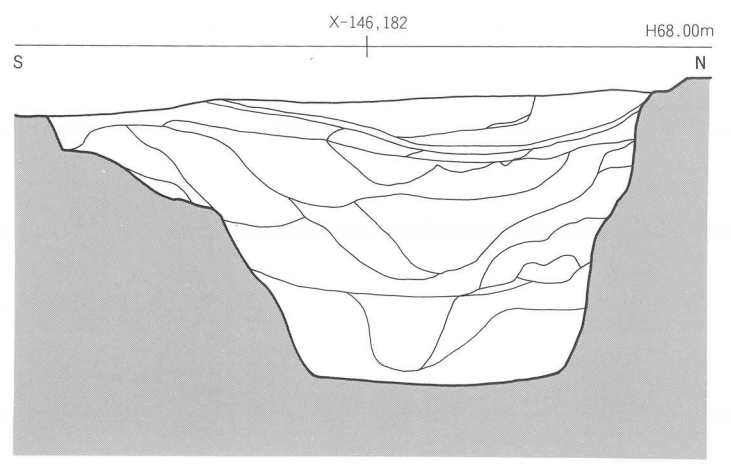

4 SE4580

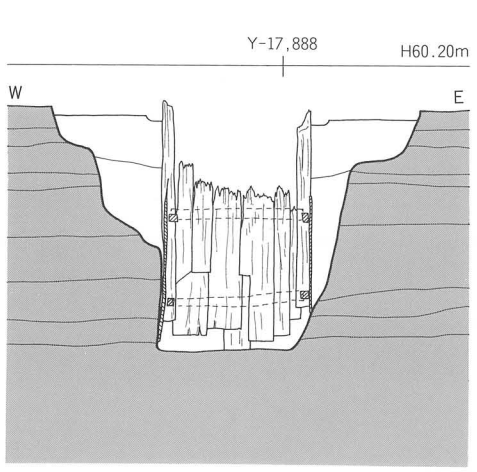
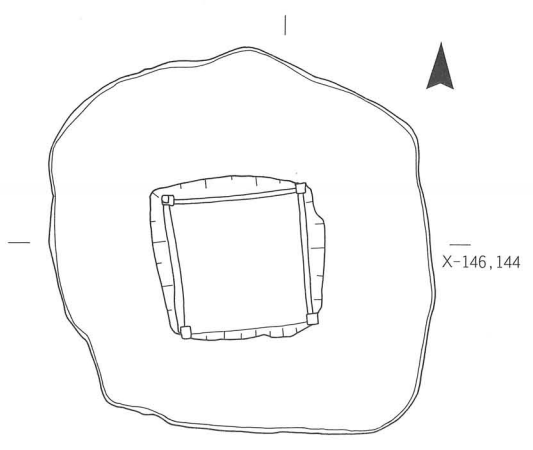

2 SE4815

1~3 1:50 4 1:60

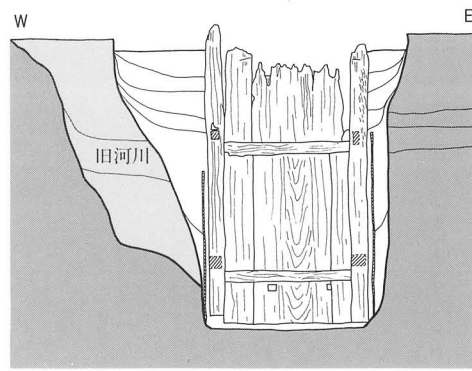
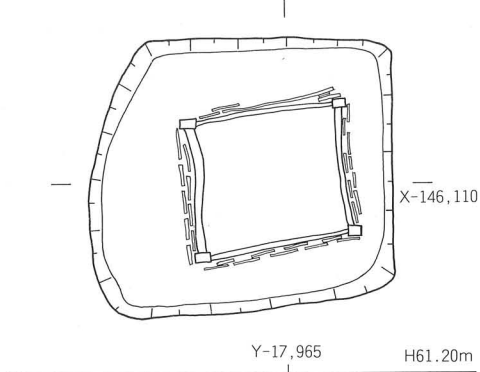
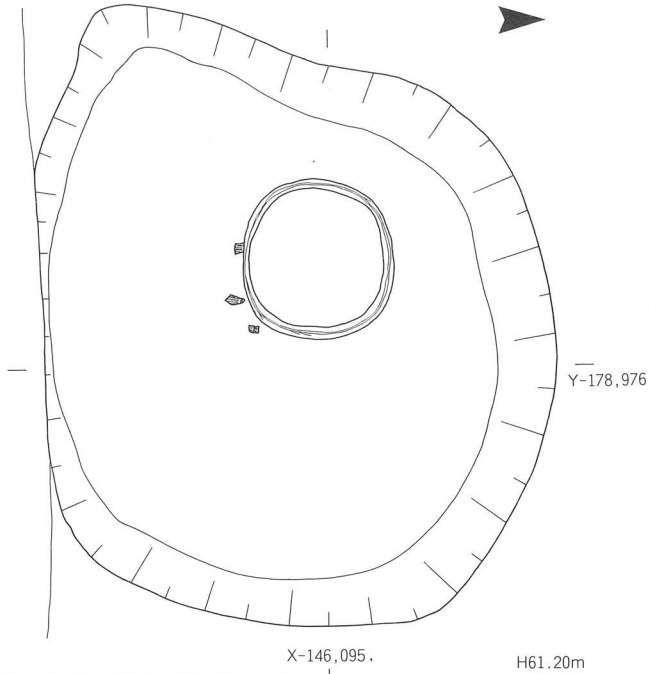

3 SE5135

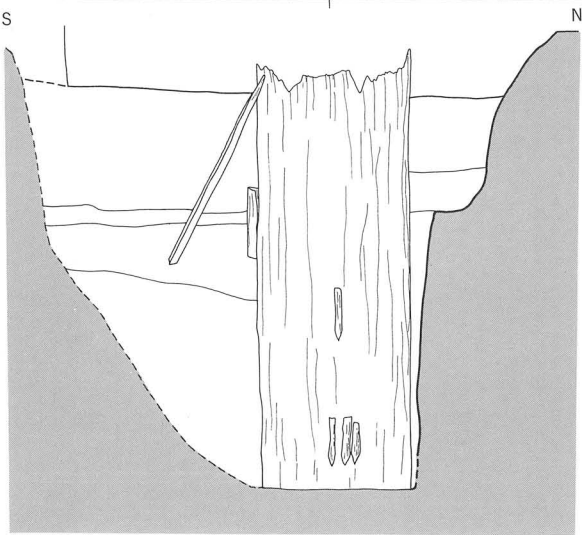

1 SE5140

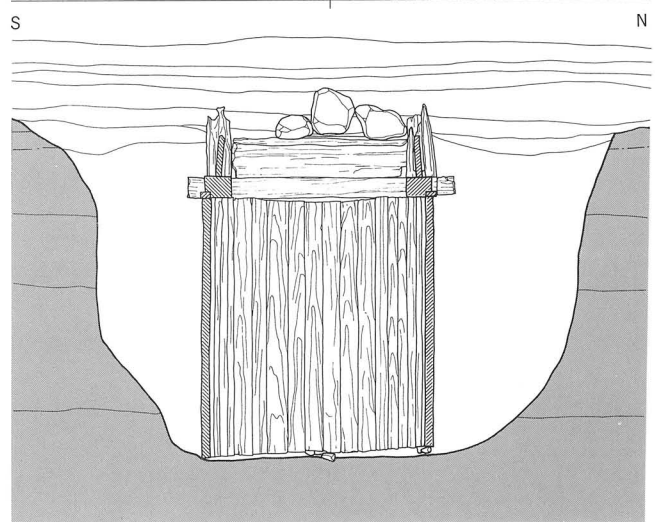
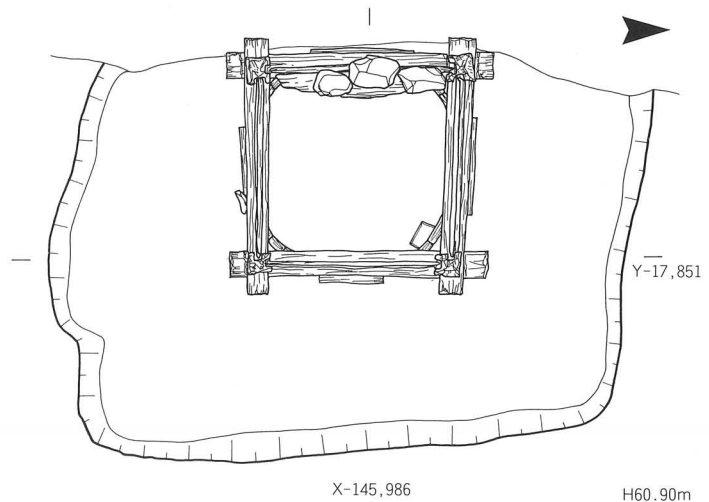

4 SE5355

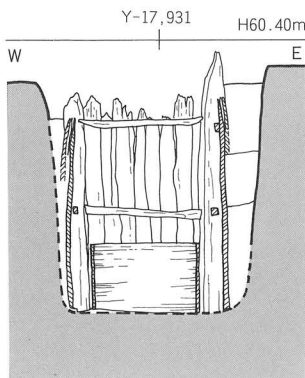
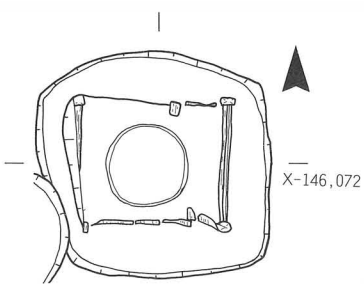

2 SE5075



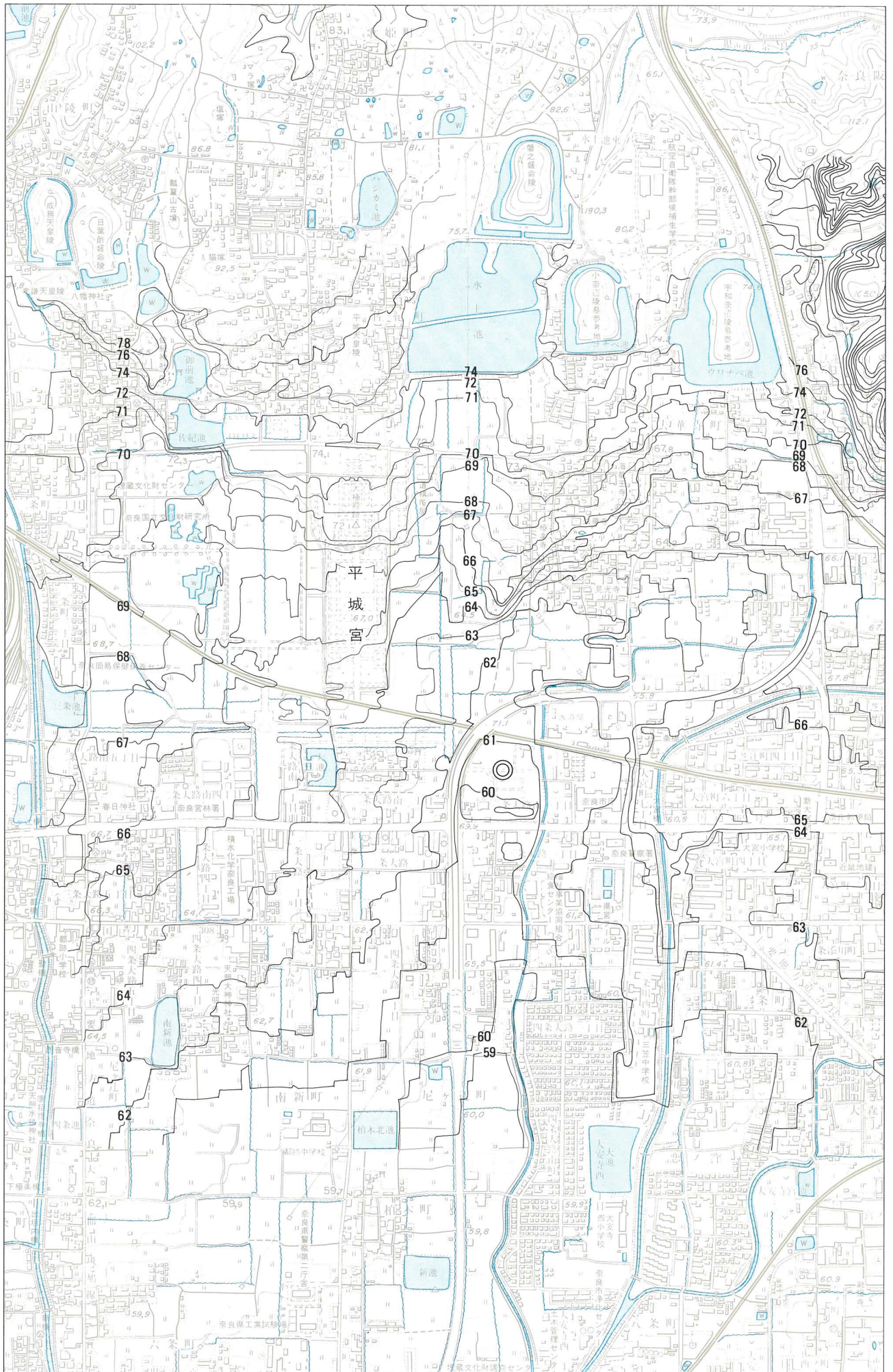

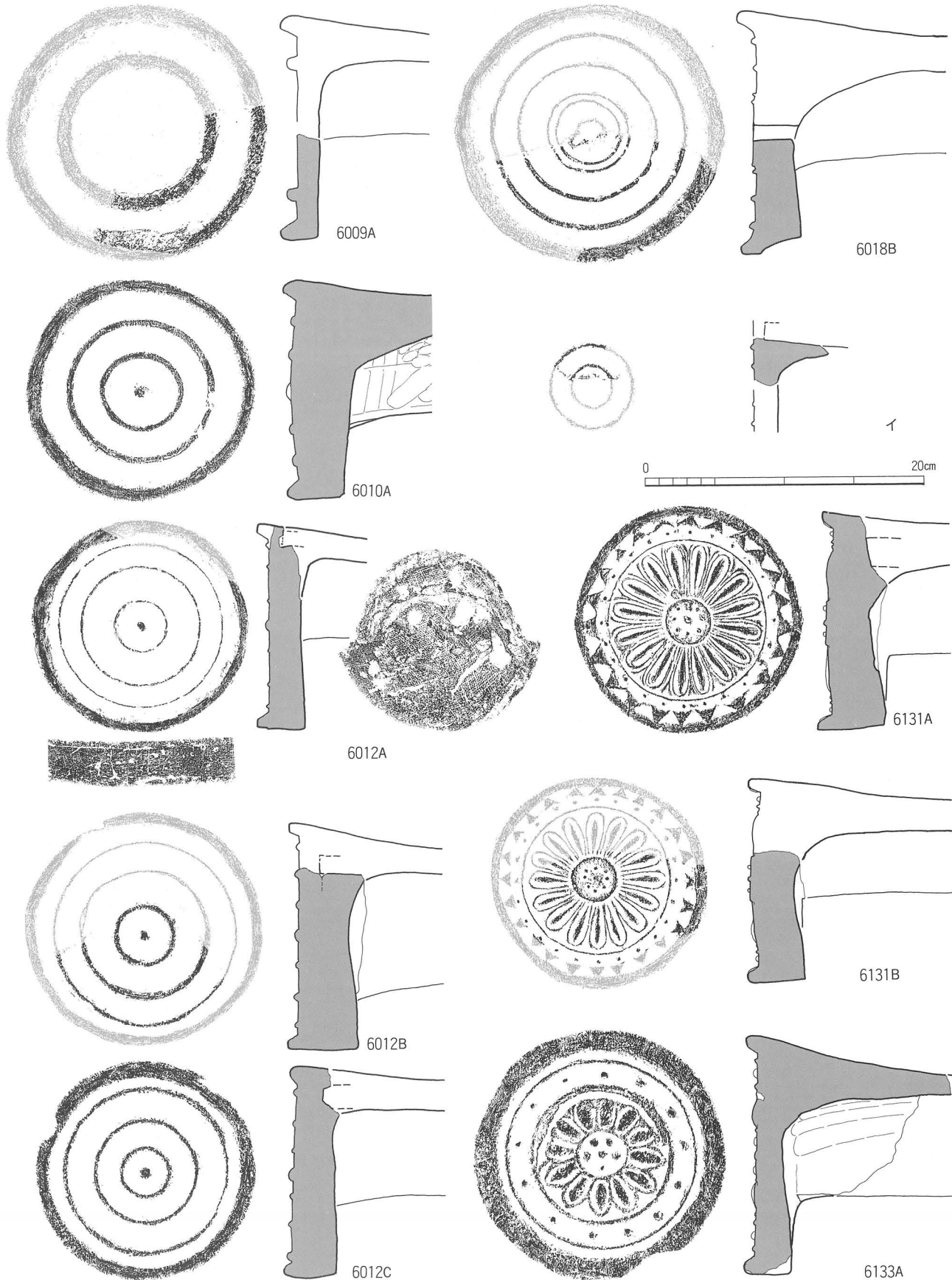

型式・種	直径	内区					外区		外縁			丸瓦 取り付き	全長	玉縁長		
		内区径	第1圈径	第2圈径	第3圈径	第4圈径	幅	文様	幅	高さ	文様				形態	
6009-A									7	13		傾斜縁Ⅰ				
6010-A	162		62	108					11	9		傾斜縁Ⅰ				
6012-A	148		40	89	121				7	12		傾斜縁Ⅰ				
6012-B	158		48	95	132				7	9		傾斜縁Ⅰ				
6012-C	154		39	78	125				11	8		傾斜縁Ⅰ				
イ				10												
6018-B	172		48	61	99	138			9	11		傾斜縁Ⅱ				
6131-A	166	40	なし	1+8	124	T 16	A	8	S 22	13	11	RV 23	傾斜縁Ⅰ	45°		
6131-B	155	32	なし	1+8	111	T 16	A	8	S 24	13	11	RV 24	傾斜縁Ⅰ	同じ		
6133-A	168	34	あり	1+5	96	T 12	なし	19	S 13	17	9		傾斜縁Ⅰ	同じ	400	50

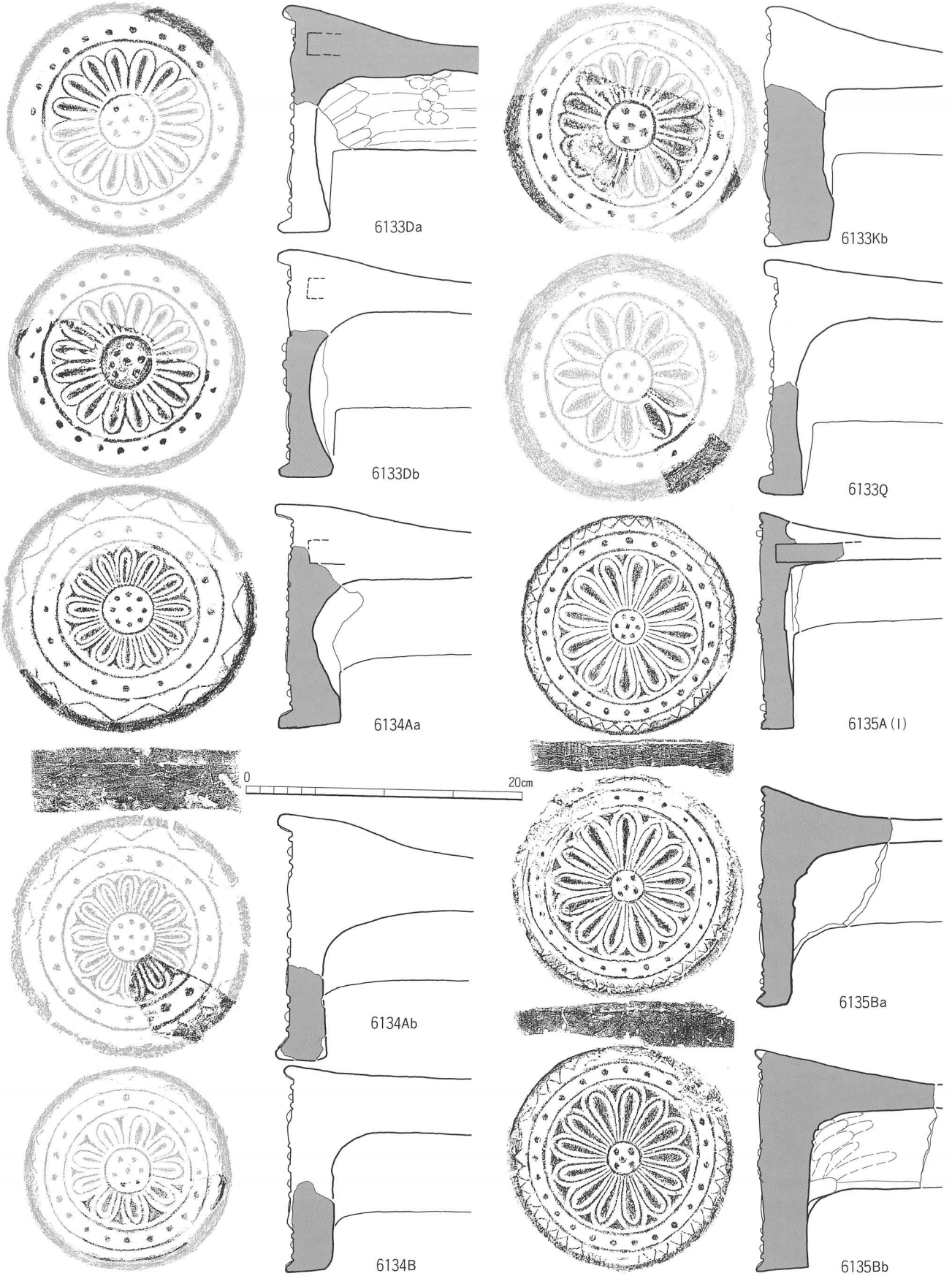

型式・種	直径	内 区							外 区		外 縁			丸瓦 取り付け	全長	玉縁長
		中房径	圏線	連子数	弁区径	弁数	間弁	幅	文様	幅	高さ	文様	形態			
6133-Da	157	40	あり	1+6	111	T 16	なし	14	S 24	10	10	傾斜縁 I	180°			
6133-Db	163	43	なし	1+6	111	T 16	なし	16	S 24	10	10	傾斜縁 I	180°		48	
6133-Kb	175	36	あり	1+5	117	T 16	なし	15	S 27	14	7	LV ? 傾斜縁 I	同じ			
6133-Q	178	34	あり	1+6	116	T 12	なし	14	S 16	17	9	直立縁				
6134-Aa	167	36	あり	1+8	103	T 12	A	16	S 16	16	11	LV 16 傾斜縁 I	180°			
6134-B	146	34	あり	1+6	94	T 9	A	14	S(?)	12	3	LV(?) 傾斜縁 I				
6135-A	168	28	あり	1+6	112	T 12	A	14	S 25	14	4	LV 46 傾斜縁 I	180°	389	37	
6135-Ba	162	24	あり	1+4	116	T 13	A	12	S 24	11	4	LV(?) 三角縁	180°			
6135-Bb	160	15	あり	1+4	112	T 13	A	11	S 24	13	8	LV(?) 三角縁	180°			

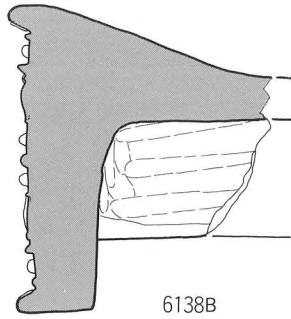
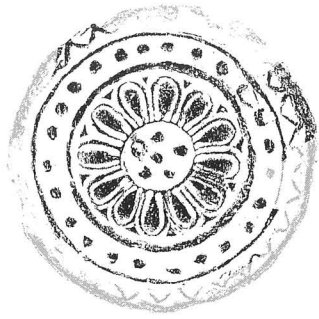

6138B

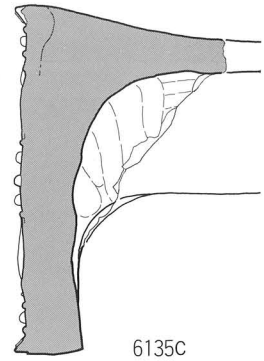
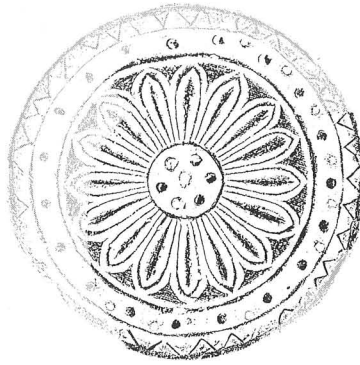

6135C

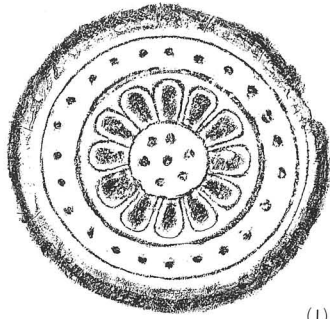

(1)

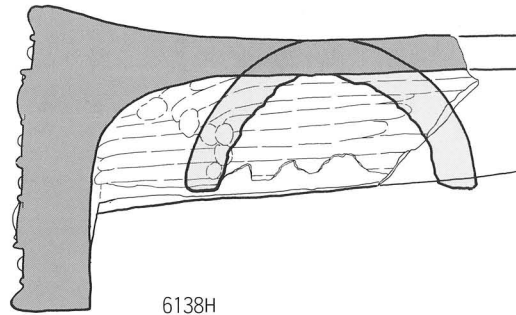

6138H

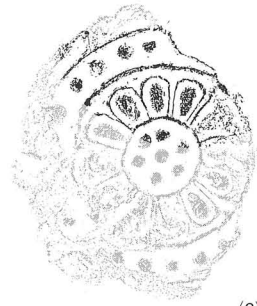

(2)

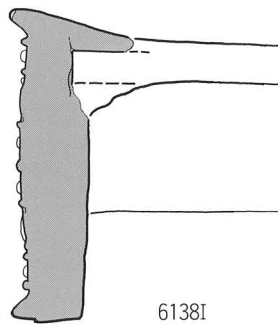
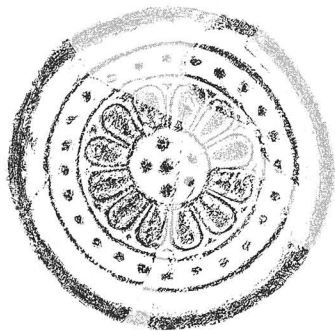

6138I

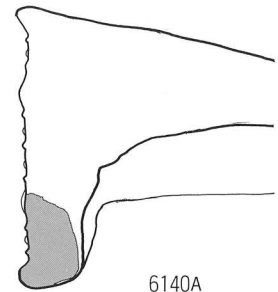
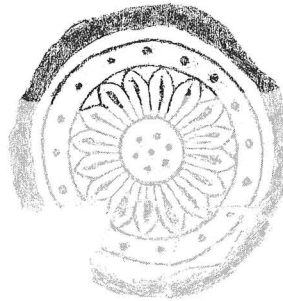

6140A

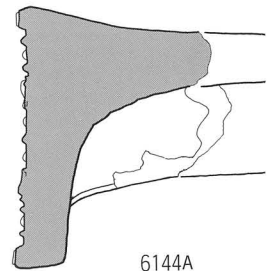
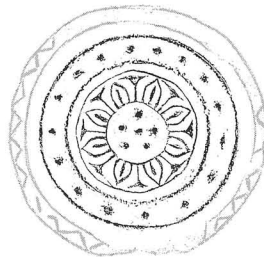

6144A

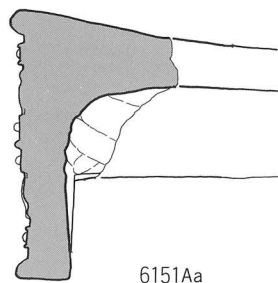
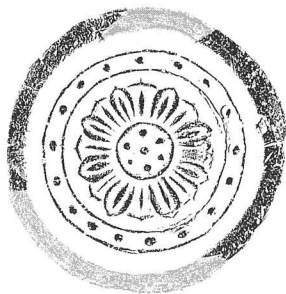

6151Aa

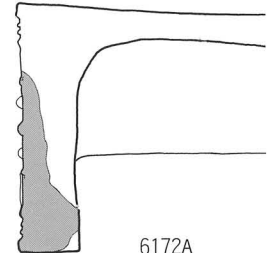
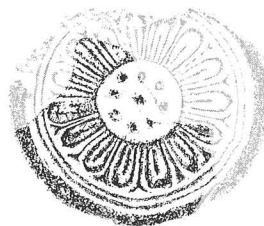

6172A



型式・種	直径	内 区						外 区		外 縁				丸瓦 取り付き	全長	玉縁長
		中房径	圏線	連子数	弁区径	弁数	間弁	幅	文様	幅	高さ	文様	形態			
6135-C	185	39	なし	1+6	135	T 16	A	15	S 19	11	7	LV(?)	三角縁	180°		
6138-B	165	37	あり	1+5	95	T 12	A	19	S 24	16	13	LV(?)	傾斜縁 I	45°		
6138-H		41	あり	1+6	93	T 12	A	19	S(?)	15	10		傾斜縁 I			
6138-I	161	40	あり	1+5	95	T 12	A	16	S 24	17	13		傾斜縁 I	180°		
6140-A			あり										傾斜縁 II			
6144-A	135	31	なし	1+5	75	T 8	A	14	S 16	16	5	LV ?	直立縁			
6151-A	139	30	あり	1+6	85	T 8	A	10	S 17	17	5		傾斜縁 I	180°		
6172-A		46	あり	1+8		T 16	A	4	K	16	5		直立縁			

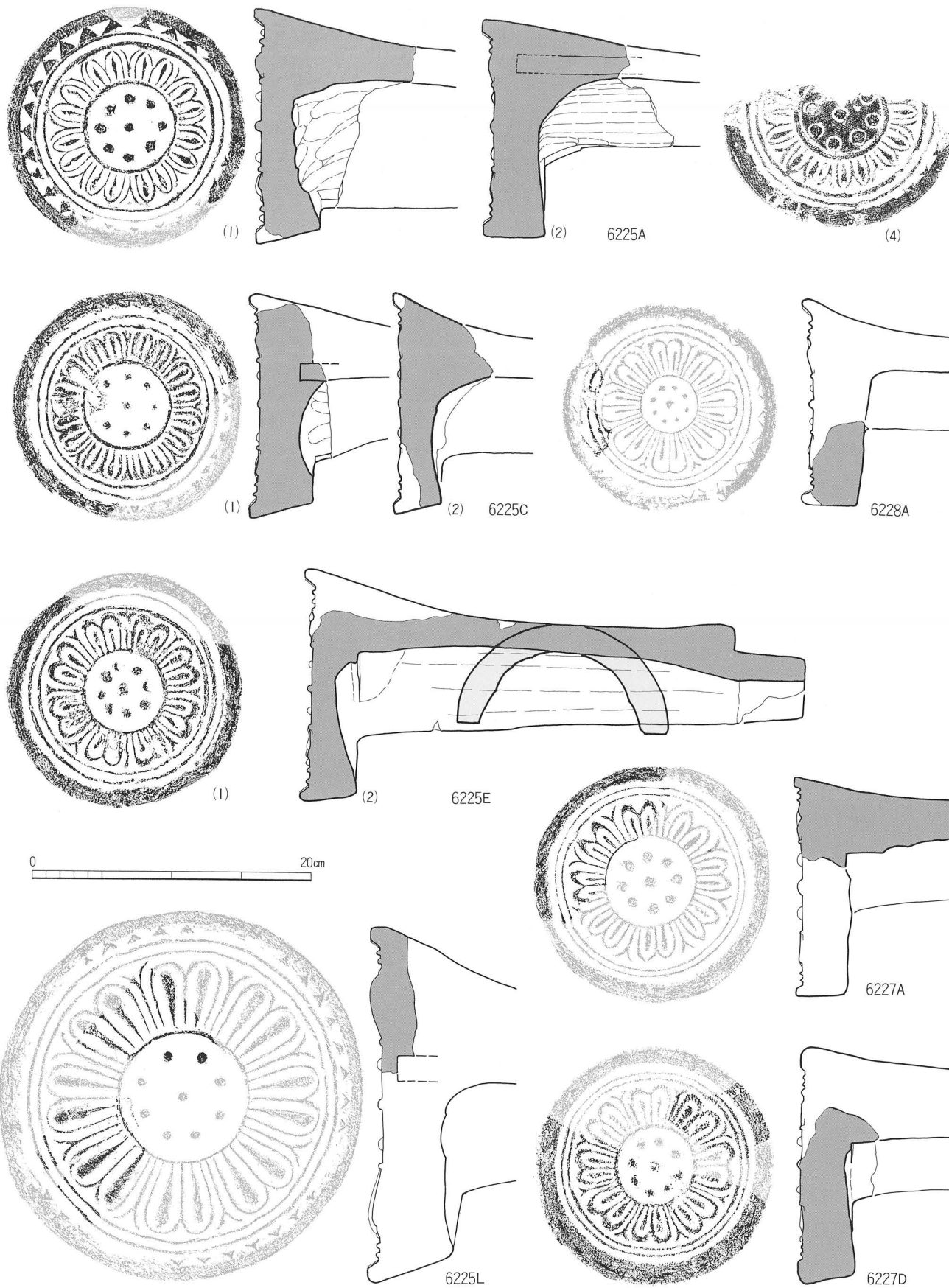

型式・種	直径	内 区							外 区		外 縁				丸瓦 取り付け	全長	玉縁長
		中房径	圏線	連子数	弁区径	弁数	間弁	幅	文様	幅	高さ	文様	形態				
6225-A	166	68	あり	1+8	116	F 8	A	12	K	13	8	RV 26	傾斜縁 I		373	48	
6225-C	155	62	あり	1+8	111	F 8	A	7	K	15	7	RV 32	傾斜縁 I				
6225-E	165	61	あり	1+8	119	F 8	A	11	K	12	6	RV ?	傾斜縁 I	180°			
6225-L	245	93	あり	1+8	204	F 8	A	8	K	17	6	RV 40	傾斜縁 I		422	52	
6227-A	161	60	あり	1+8	125	F 8	A	5	K	13	5		直立縁	90°			
6227-D	170	57	あり	1+8	122	F 8	A	4	K	20	4		直立縁	同じ			
6228-A	142	44	あり	1+8	108	F 8	A	5	K	12	4		傾斜縁 II				

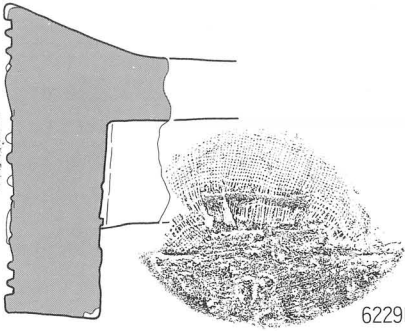
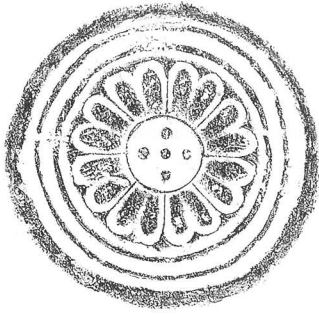

6229B

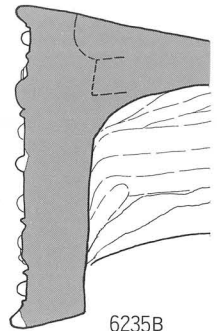
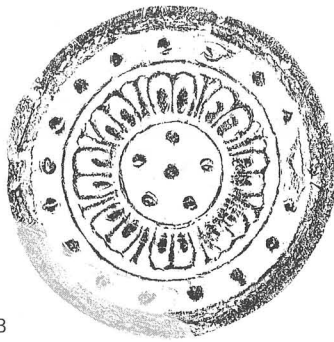

6235B

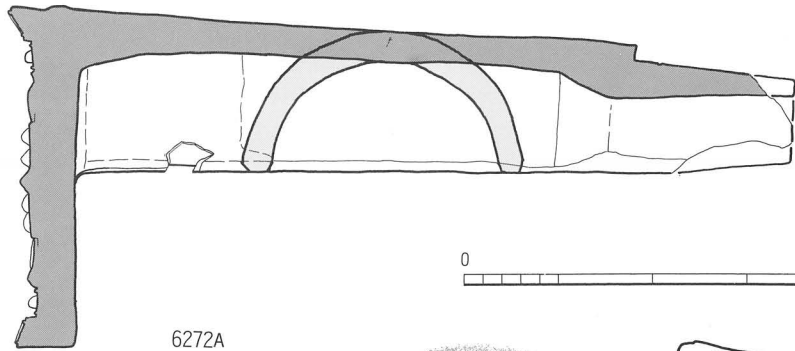
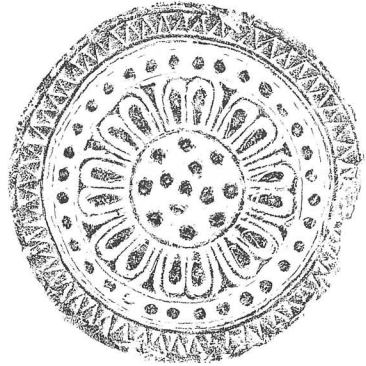

6272A

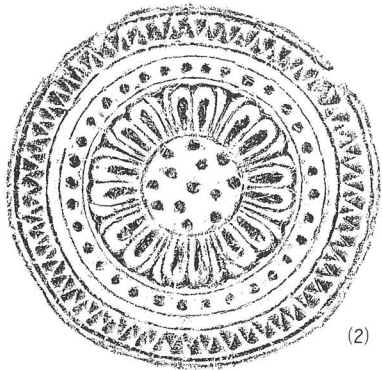
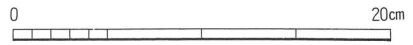

(2)

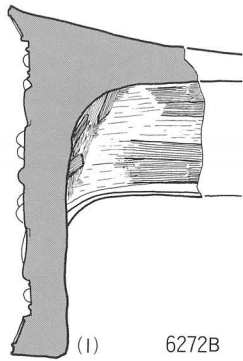

(1)

6272B

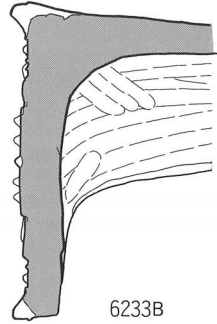
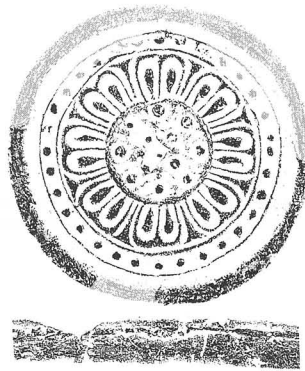

6233B



(1)

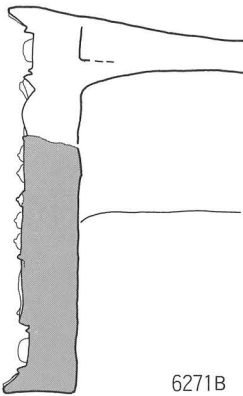
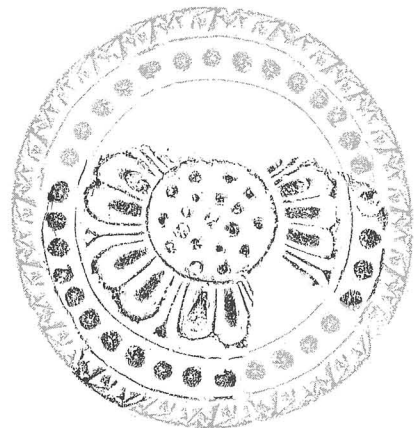

6271B

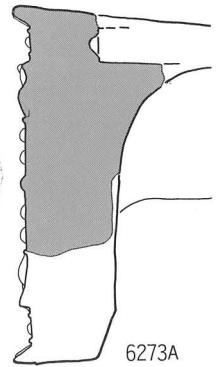
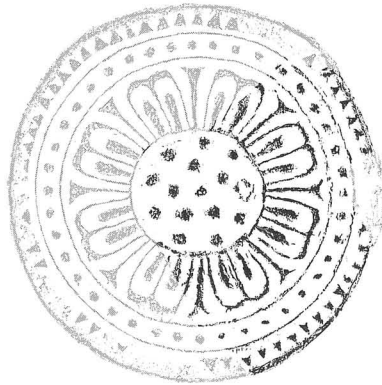

6273A

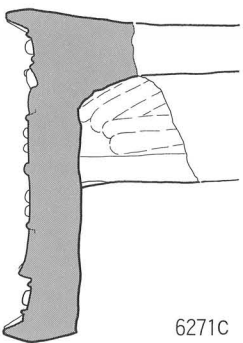
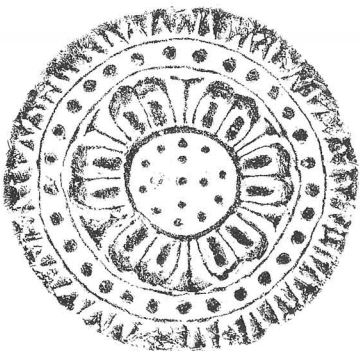

6271C

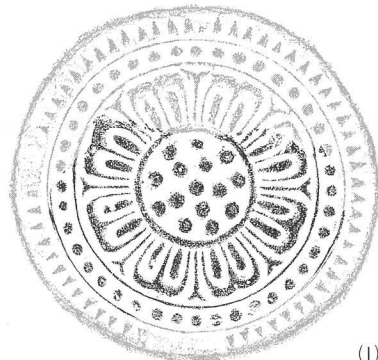

(1)

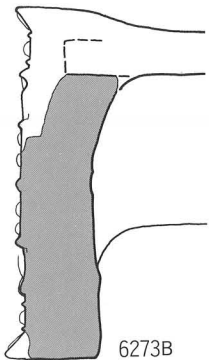

6273B



(2)

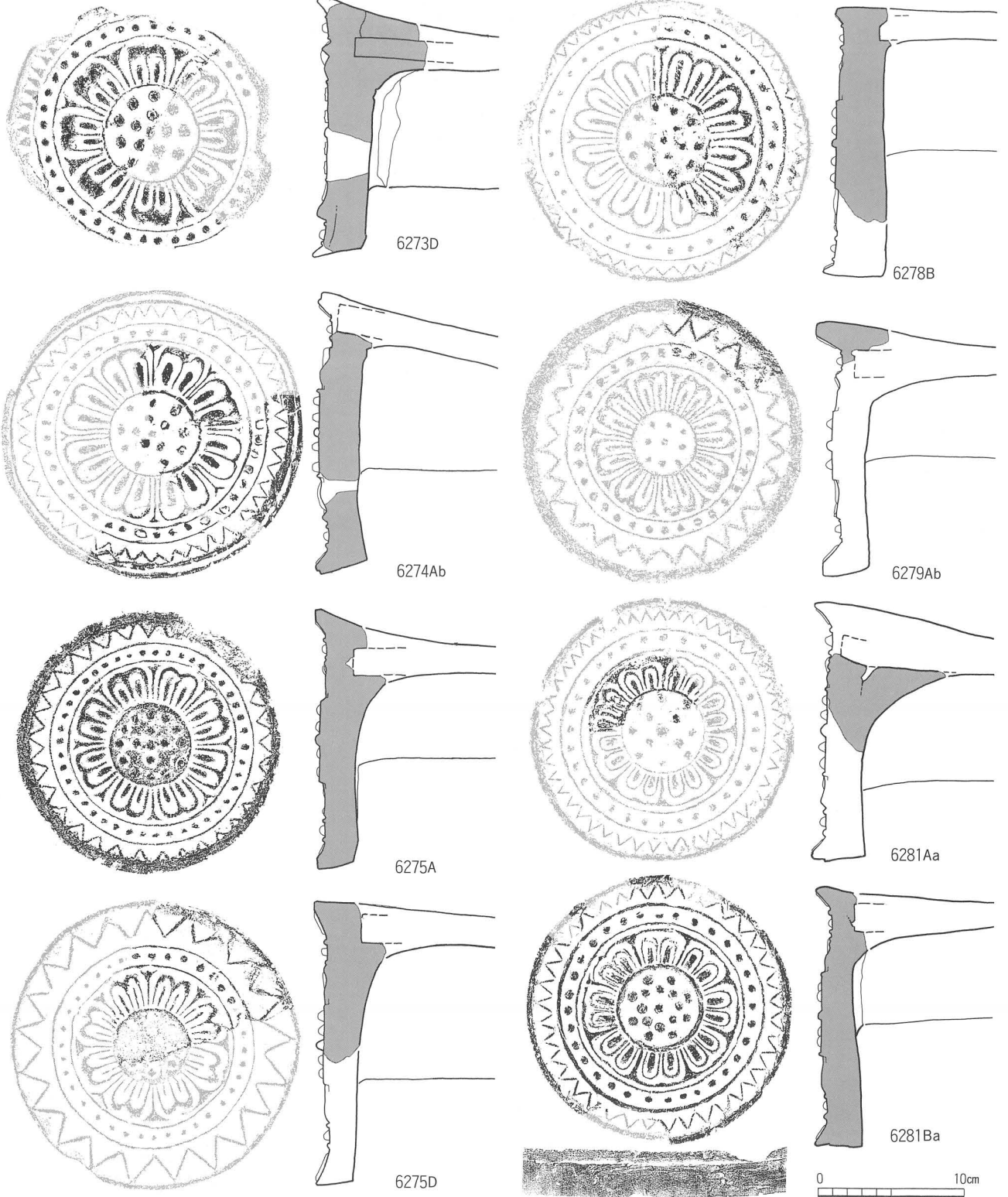

型式・種	直径	内				区		外		外			縁		丸瓦 取り付け	全長	玉縁長
		中房径	圏線	連子数	弁区径	弁数	間弁	幅	文様	幅	高さ	文様	形態				
6229-B	165	41	あり	1+4	113	F 8	A	10	K	16	5		直立縁				
6233-B	154	56	なし	1+4+8	106	F 8	A	11	S 32	13	8		傾斜縁 I	同じ			
6235-B	183	56	あり	1+5	123	F 8	A	19	S 16	11	8		三角縁	同じ			
6271-B	(207)	67	あり	1+8+10	141	F ?	A	21	S(?)	12	13	MV(?)	三角縁				
6271-C	175	56	あり	1+4+10	119	F 6	A	14	S 29	14	17	MV(?)	三角縁				
6272-A	181	60	あり	1+4+8	113	F 8	A	15	S 32	19	6	RV 56	三角縁		424	90	
6272-B	190	54	なし	1+4+8	114	F 8	A	13	S 33	25	4	RV(58)	三角縁				
6273-A	186	70	あり	1+5+9	132	F 8	A	13	S 40	14	13	RV 64	三角縁	同じ	447	62	
6273-B	180	64	あり	1+5+9	128	F 8	A	13	S 40	13	12	RV 64	三角縁	同じ			
6273-D	(179)	70	あり	1+5+9	125	F 8	A	13	S 40	14	10	RV 64	三角縁				
6274-Ab	185	59	あり	1+5+9	126	F 8	A	13	S 40	17	13	LV 42	三角縁	90°	376	60	
6275-A	182	57	なし	1+4+12	116	F 8	A	12	S 43	21	11	LV 32	傾斜縁 II	同じ			
6275-D	196	54	なし	1+4+8	108	F 8	A	13	S 36	31	14	LV 21	三角縁		464	44	
6278-B	185	61	なし	1+5+10	131	F 8	A	16	S 35	14	9	LV 52	三角縁	同じ			
6279-Ab	176	47	なし	1+8	104	F 8	A	12	S 31	24	13	LV 27	傾斜縁 I		431	59	
6281-Aa	173	55	なし	1+4+8	109	F 8	B	14	S 32	18	10	LV 46	三角縁	同じ	490		
6281-Ba	184	62	あり	1+8+8	120	F 8	B	13	S 32	19	11	LV 37	三角縁	同じ			

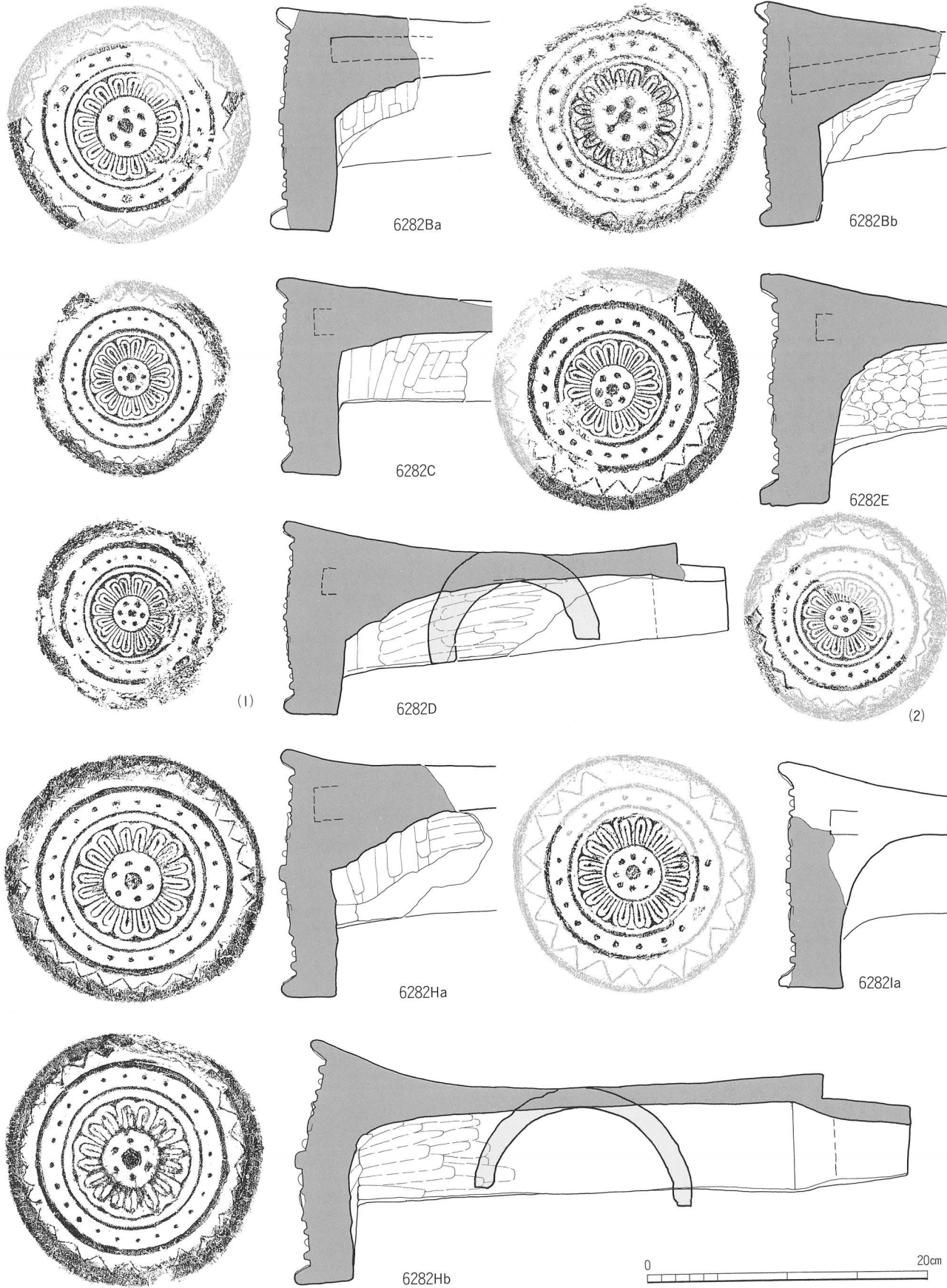

型式・種	直径	内				区		外区		外縁				丸瓦 取り付け	全長	玉縁長
		中房径	圏線	連子数	弁区径	弁数	間弁	幅	文様	幅	高さ	文様	形態			
6282-Ba	162	45	あり	1+6	86	F 8	B	20	S 24	15	9	LV 24	傾斜縁 I	361	53	
6282-Bb	162	42	あり	1+6	90	F 8	B	16	S 24	21	9	LV 24	傾斜縁 I	361		
6282-C	132	27	あり	1+6	64	F 8	B	20	S 24	14	9	LV 24	傾斜縁 III	341	37	
6282-D	132	27	あり	1+6	64	F 8	B	20	S 24	14	9	LV 24	傾斜縁 III	341	39	
6282-E	160	34	あり	1+6	76	F 8	B	24	S 24	18	13	LV 24	傾斜縁 I	387	37	
6282-Ha	174	40	あり	1+6	96	F 8	B	23	S 24	16	16	LV 22	傾斜縁 I	57		
6282-Hb	176	38	あり	1+6	100	F 9	B	17	S 24	21	12	LV(?)	傾斜縁 I	431	56	
6282-Ia	160	41	あり	1+8	90	F 8	B	16	S 20	19	14	LV 20	傾斜縁 II			

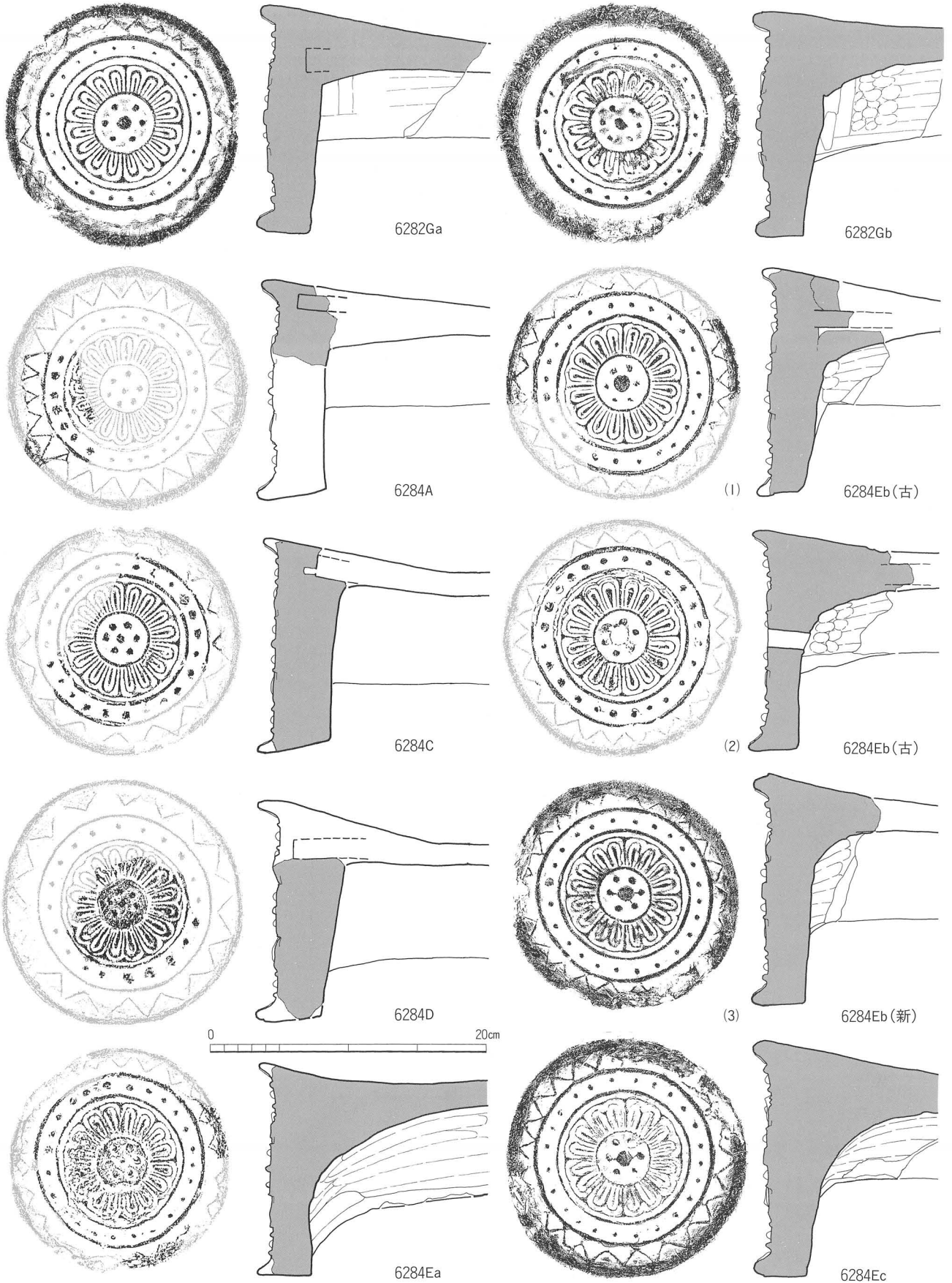

型式・種	直径	内 区						外 区		外 縁				丸瓦 取り付け	全長	玉縁長
		中房径	圏線	連子数	弁区径	弁数	間弁	幅	文様	幅	高さ	文様	形態			
6282-Ga	160	46	あり	1+6	90	F 8	B	17	S 24	18	11	LV 25	傾斜縁Ⅲ			
6282-Gb	170	45	あり	1+6	97	F 8	B	14	S 24	34	14	LV (27)	傾斜縁Ⅲ			
6284-A	155	35	あり	1+6	83	F 8	B	18	S 24	18	13	LV 23	傾斜縁Ⅰ	同じ		
6284-C	155	40	あり	1+6	89	F 8	B	20	S 24	13	11	LV 16	傾斜縁Ⅰ	180°	375	48
6284-D	163	38	あり	1+6	91	F 8	B	16	S 20	20	20	LV 16	傾斜縁Ⅰ	同じ		
6284-Ea	155	38	あり	1+6	93	F 8	B	15	S 24	16	10	LV (?)	傾斜縁Ⅰ	180°		
6284-Eb	158	40	あり	1+6	92	F 8	B	20	S 24	13	14	LV 24	傾斜縁Ⅰ	180°	360	42
6284-Ec	158	40	あり	1+6	92	F 8	B	20	S 24	13	14	LV 24	傾斜縁Ⅰ	180°	360	42

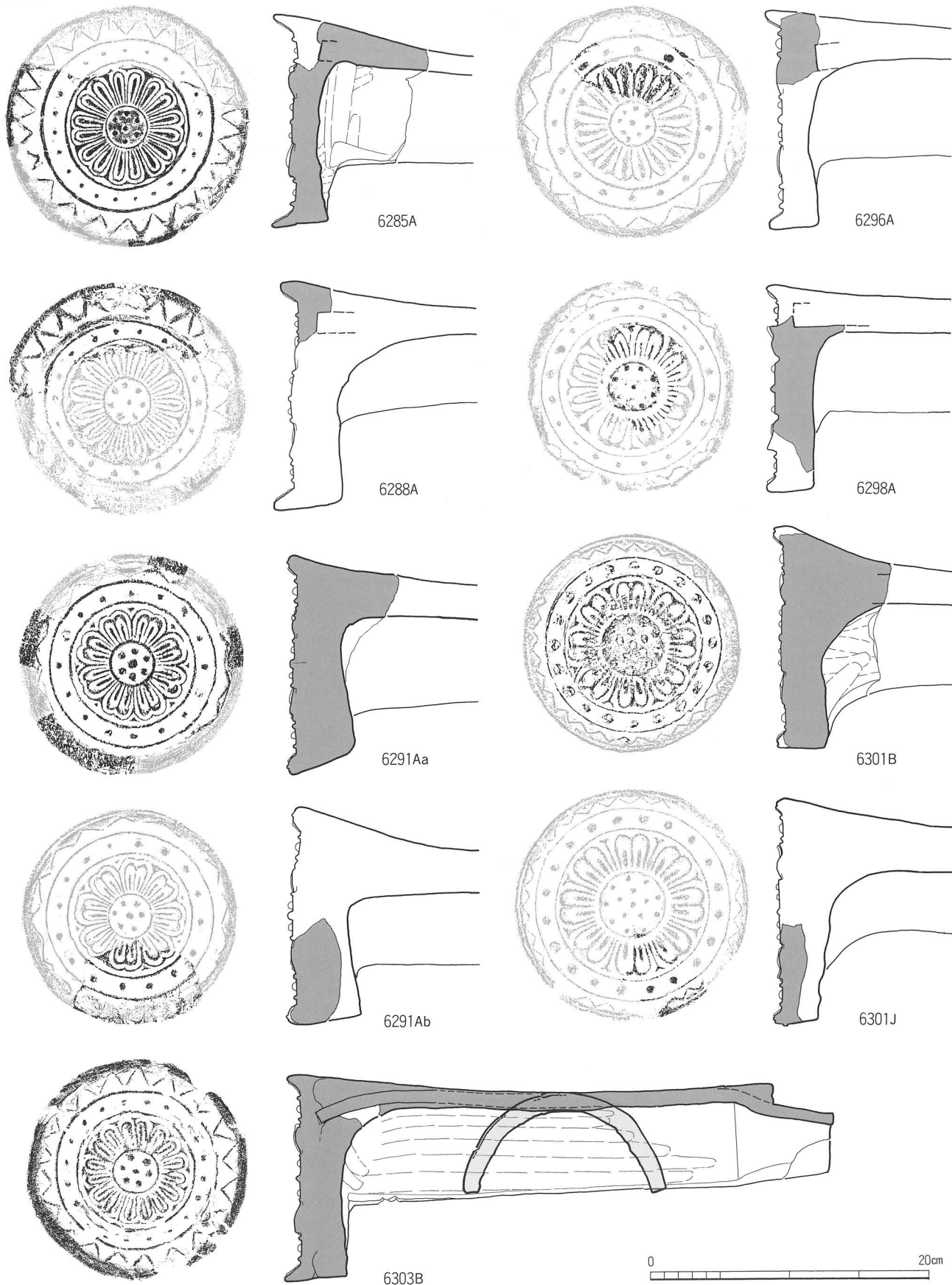

型式・種	直径	内							区		外				縁		丸瓦 取り付け	全長	玉縁長
		中房径	圏線	連子数	弁区径	弁数	間弁	幅	文様	幅	高さ	文様	形態	傾斜縁	傾斜縁				
6285-A	160	30	あり	1+6	88	F 8	B	16	S 23	20	21	LV 22	傾斜縁Ⅱ	同じ	370	55			
6288-A	158	33	あり	1+7	90	F 7	B	11	S 18	23	13	LV(?)	傾斜縁Ⅱ						
6291-Aa	161	35	あり	1+6	87	F 8	B	18	S 16	19	8	LV 16	傾斜縁Ⅲ	90°	370	41			
6291-Ab	161	33	あり	1+6	87	F 8	B	18	S 16	19	8	LV 16	傾斜縁Ⅲ						
6296-A	166	36	あり	1+8	99	F 8	なし	16	S 16	17	12	LV 17	傾斜縁Ⅰ						
6298-A		40	なし	1+8		F (9)	A						傾斜縁Ⅰ						
6301-B	166	48	なし	1+5+9	106	F 8	A	15	S 20	15	8	LV 30	三角縁	90°					
6301-J	163	48	なし	1+5+9	108	F 8	A	14	S 20	13	9	LV(?)K	傾斜縁Ⅰ						
6303-B	153	33	あり	1+6	85	F 8	B	15	S 20	19	11	LV 20	傾斜縁Ⅱ	180°	397	46			

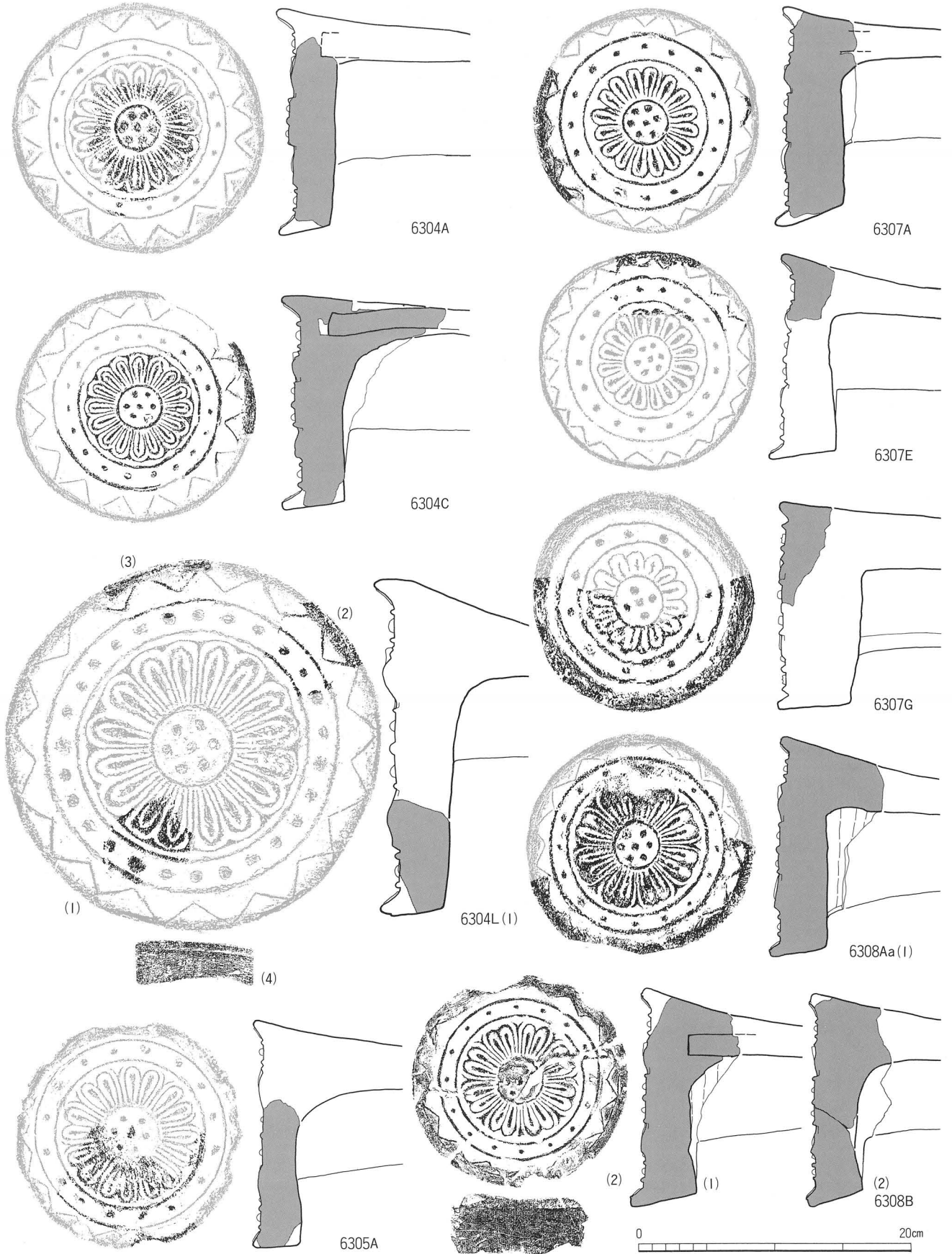

型式・種	直径	内						外		外				丸瓦 取り付け	全長	玉縁長
		中房径	圏線	連子数	弁区径	弁数	間弁	幅	文様	幅	高さ	文様	形態			
6304-A	162	35	あり	1+6	99	F 8	B	15	S 17	16	16	LV 16	傾斜縁Ⅱ	同じ		
6304-C	160	32	あり	1+6	88	F 8	B	15	S 19	21	17	LV 16	傾斜縁Ⅱ			
6304-L	255	61	あり	1+6	159	F 8	B	23	S 27	25	14	LV 17	傾斜縁Ⅱ	180°		
6305-A	165	41	なし	1+6	107	F 8	A	14	S 16	15		LV(?)	三角縁			
6307-A	168	35	あり	1+6	92	F 8	なし	20	S 16	18	10	LV 16	傾斜縁Ⅱ	同じ		
6307-E	153	35	あり	1+6	85	F 8	なし	17	S 17	17	10	LV 21	傾斜縁Ⅱ			
6307-G	156	35	あり	1+4	86	F 7	なし	17	S 11	18	9		傾斜縁Ⅰ	180°	361	50
6308-Aa	162	35	あり	1+6	94	F 8	A	11	S 16	23	8	LV 16	傾斜縁Ⅱ			
6308-B	162	36	あり	1+6	93	F 8	A	13	S 16	24	7	LV 16	傾斜縁Ⅰ	180°	377	

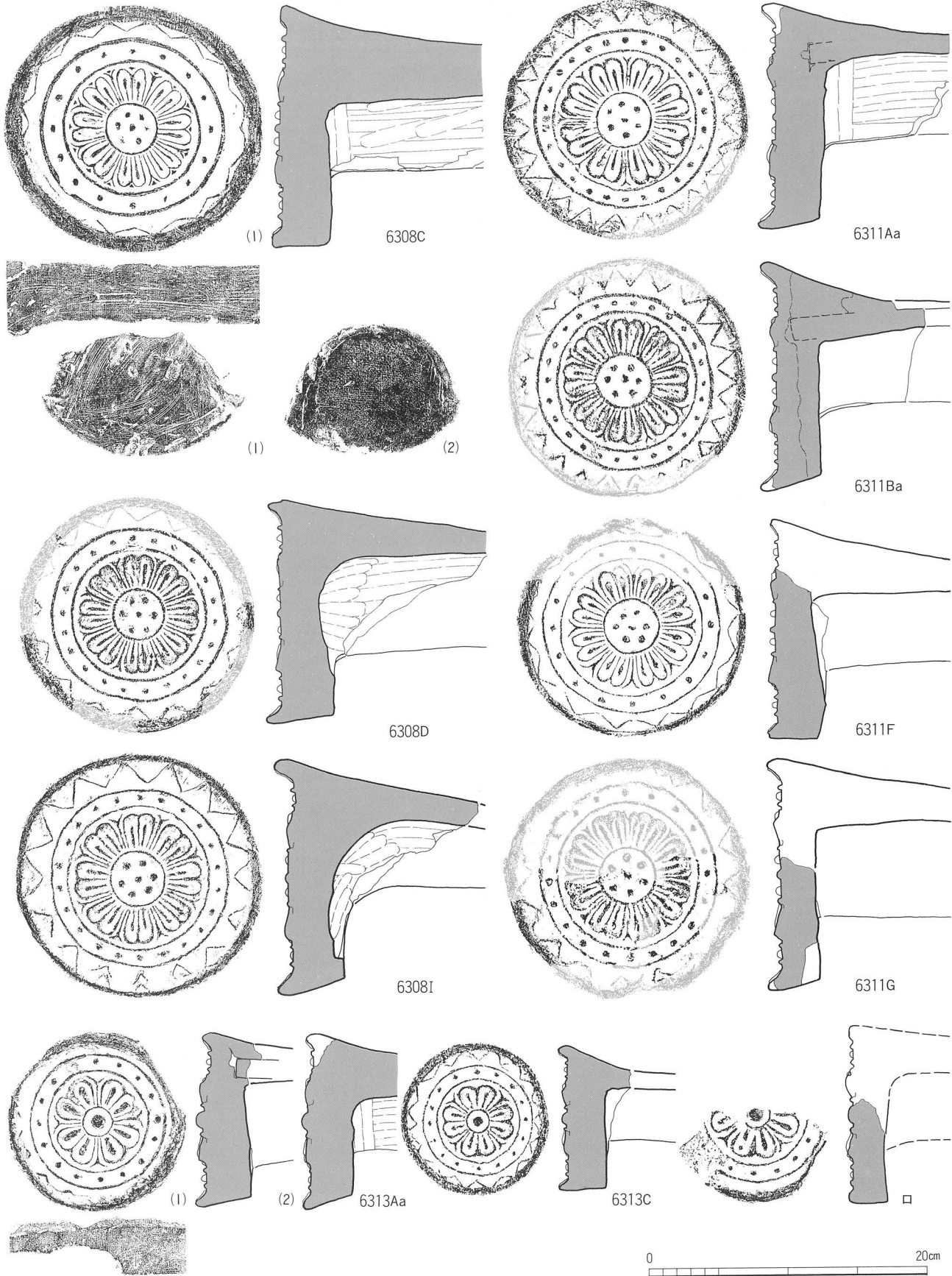

型式・種	直径	内 区							外 区		外 縁			丸瓦 取り付け	全長	玉縁長
		中房径	圏線	連子数	弁区径	弁数	間弁	幅	文様	幅	高さ	文様	形態			
6308-C	176	37	あり	1+6	98	F 8	A	16	S 16	23	8	LV 16	傾斜縁 I	同じ		
6308-D	163	36	あり	1+6	92	F 8	A	15	S 22	13	5	LV 16	傾斜縁 II	90°	405	55
6308-I	162	37	あり	1+6	98	F 8	A	12	S 22	20	15	LV 16	傾斜縁 II	同じ		
6311-Aa	161	40	あり	1+6	96	F 8	A	15	S 26	17	11	LV 23	傾斜縁 II	同じ	395	56
6311-Ba	162	43	あり	1+6	92	F 8	A	13	S 26	20	13	LV 23	傾斜縁 II	180°	376	
6311-F	159	38	あり	1+6	99	F 8	A	13	S 16	18	8	LV 16	三角縁	同じ	368	50
6311-G	163	38	あり	1+(6)	97	F 8	A	12	S 20	21	10	LV(?)	傾斜縁 II	同じ		
6313-Aa	123	24	あり	1	71	F 4	A	16	S 16	10	8	LV 16	傾斜縁 II		312	42
6313-C	95	15	あり	1	57	F 4	A	8	S 16	9	6	LV 16	傾斜縁 II		333	38
口			あり	1		T	A	13	S(?)	16	3		傾斜縁 I			

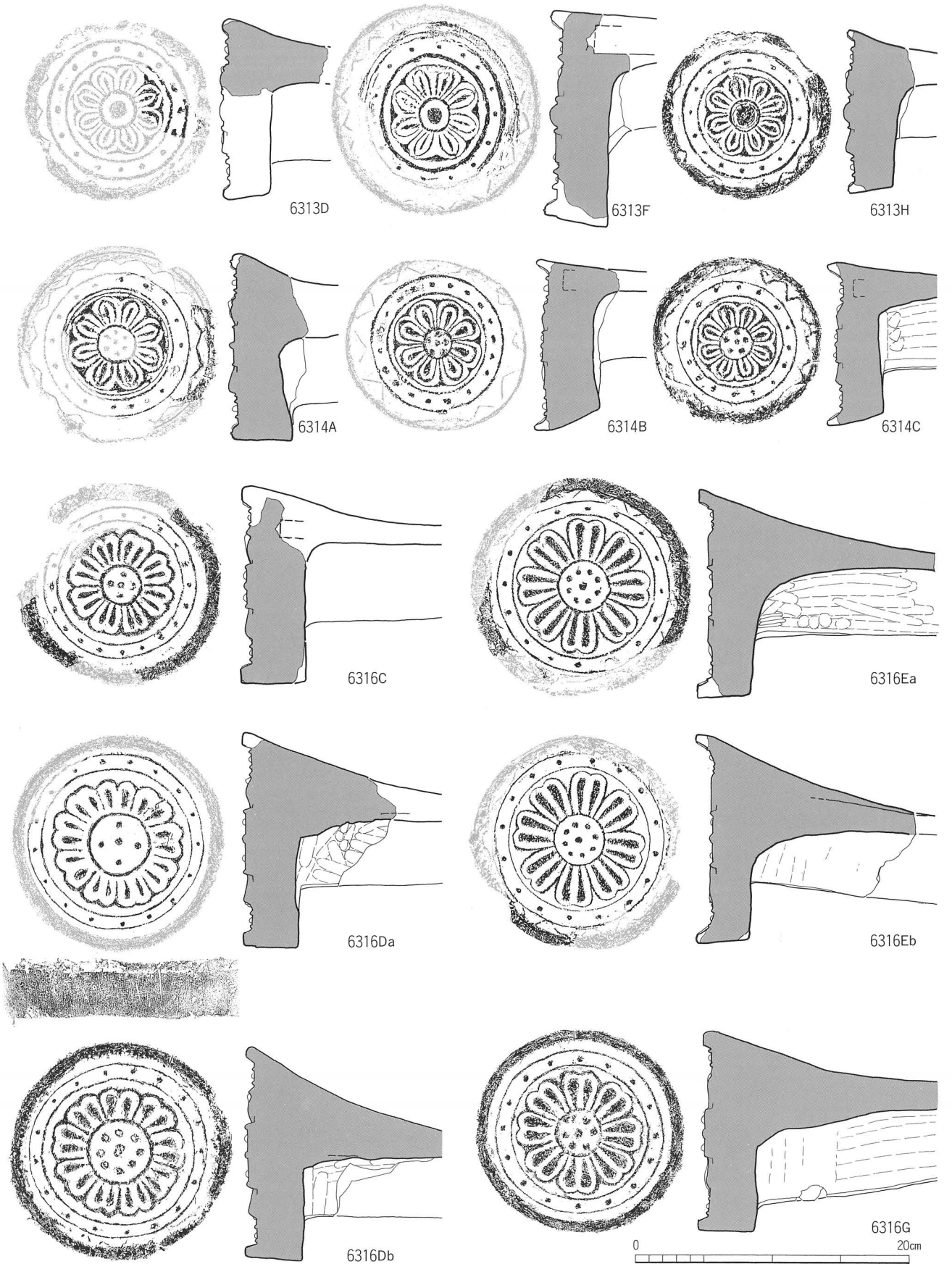

型式・種	直径	内					区			外		外 縁			丸瓦 取り付け	全長	玉縁長
		中房径	圏線	連子数	弁区径	弁数	間弁	幅	文様	幅	高さ	文様	形態				
6313-D	124	26	あり	1	74	F 4	B	13	S 16	12	6	LV(?)	傾斜縁 I	同じ	286	46	
6313-F		25	あり	1	83	F 4	B	12	S(?)	22	8	LV(?)	傾斜縁 I				
6313-H		117	あり	1	68	T 8	B	11	S 16	8	5	LV(?)	直立縁				
6314-A	140	30	あり	1+6	38	80	F 4	B	15	S 16	15	6	LV 16	直立縁	364	52	
6314-B		121	あり	1+5	34	67	F 4	B	15	S 19	12	10	LV(?)	傾斜縁 II			
6314-C		118	あり	1+5	30	78	F 4	B	11	S 16	9	13	LV(16)	傾斜縁 II			
6316-C	144	31	あり	1+4	27	89	F 8	なし	10	S 20	18	9	LV(?)	直立縁	90°		
6316-Da		153	あり	1+4	27	107	F 9	なし	10	S 17	13	9	直立縁				
6316-Db		155	あり	1+8	31	111	F 9	なし	9	S 17	13	9	直立縁				
6316-Ea	152	35	あり	1+8	31	102	F 8	なし	10	S 16	15	10	LV(?)	直立縁	90°		
6316-Eb		(153)	あり	1+8	32	105	F 8	なし	10	S 16	14	10	LV(?)	直立縁			
6316-G		147	なし	1+7	99	F 8	なし	10	S 16	14	7	LV(?)	直立縁				

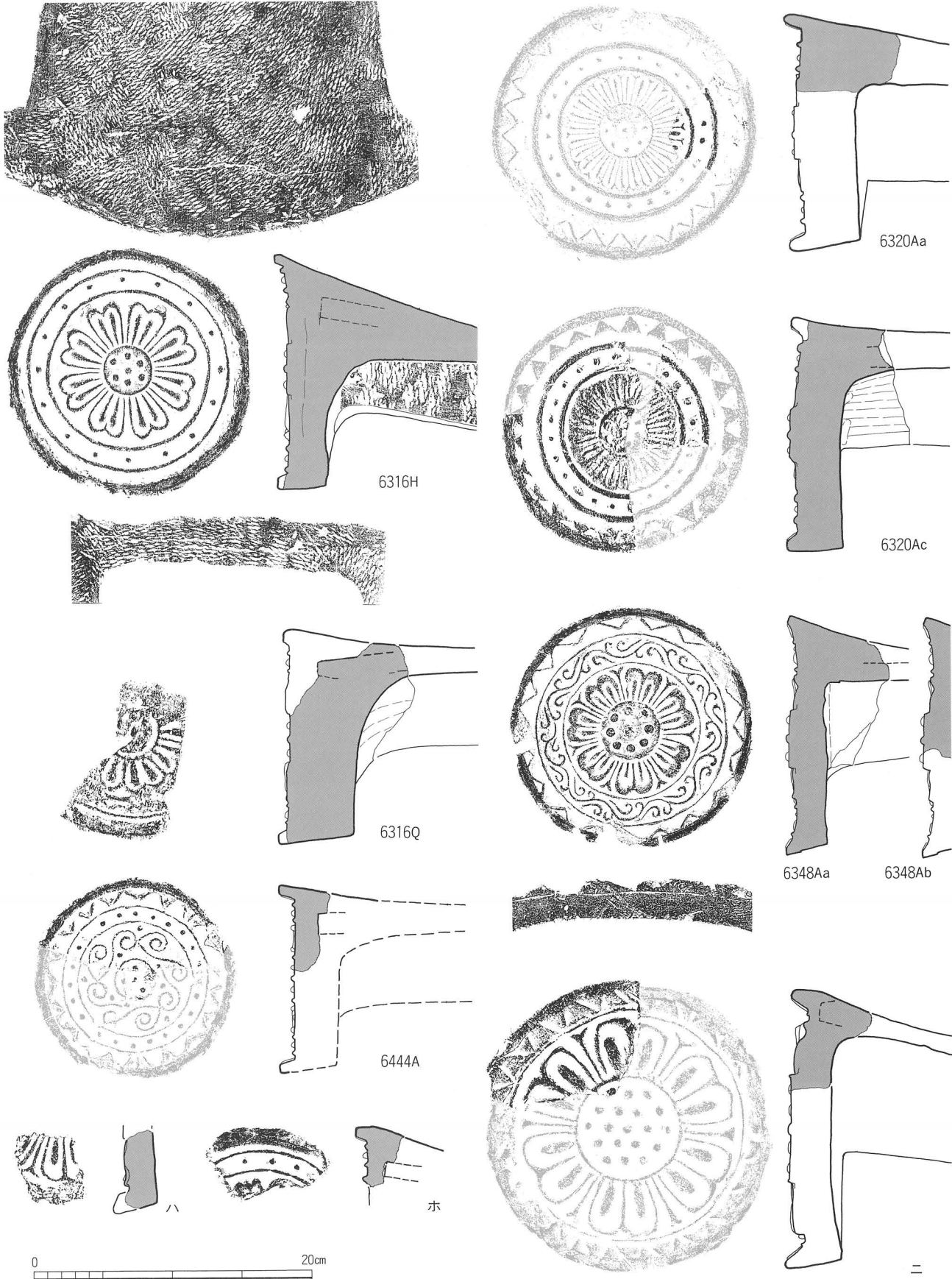

型式・種	直径	内				区		外 区		外 縁			丸瓦 取り付き	全長	玉縁長
		中房径	圏線	連子数	弁区径	弁数	間弁	幅	文様	幅	高さ	文様			
6316-H	171	35	なし	1+6	113	F 8	なし	16	S 16	13	11		傾斜縁 I	180°	
6316-Q			なし	1+?		F(?)	B					LV	傾斜縁 I		
6320-Aa	168	38	あり		96	F(?)	なし	28	S(?)	22	14	LV(?)	傾斜縁 I	180°	
6320-Ac	(170)	37	なし	1+8	92	F?	なし	16	S(?)	23	13	RV(?)	傾斜縁 I		
6348-Aa	181	47	なし	1+8	105	F 7	A	23	HK	15	7	LV 19	傾斜縁 I	180°	
6348-Ab	185	45	なし	1+8	103	F 7	A	23	HK	18	8	LV(?)	傾斜縁 I		
6444-A			あり			HK・S	なし	11	S(?)	14	11	LV(?)	直立縁		
二	228	78	あり	1+6+12	156	F	A	4		17	17	MV	傾斜縁 I		

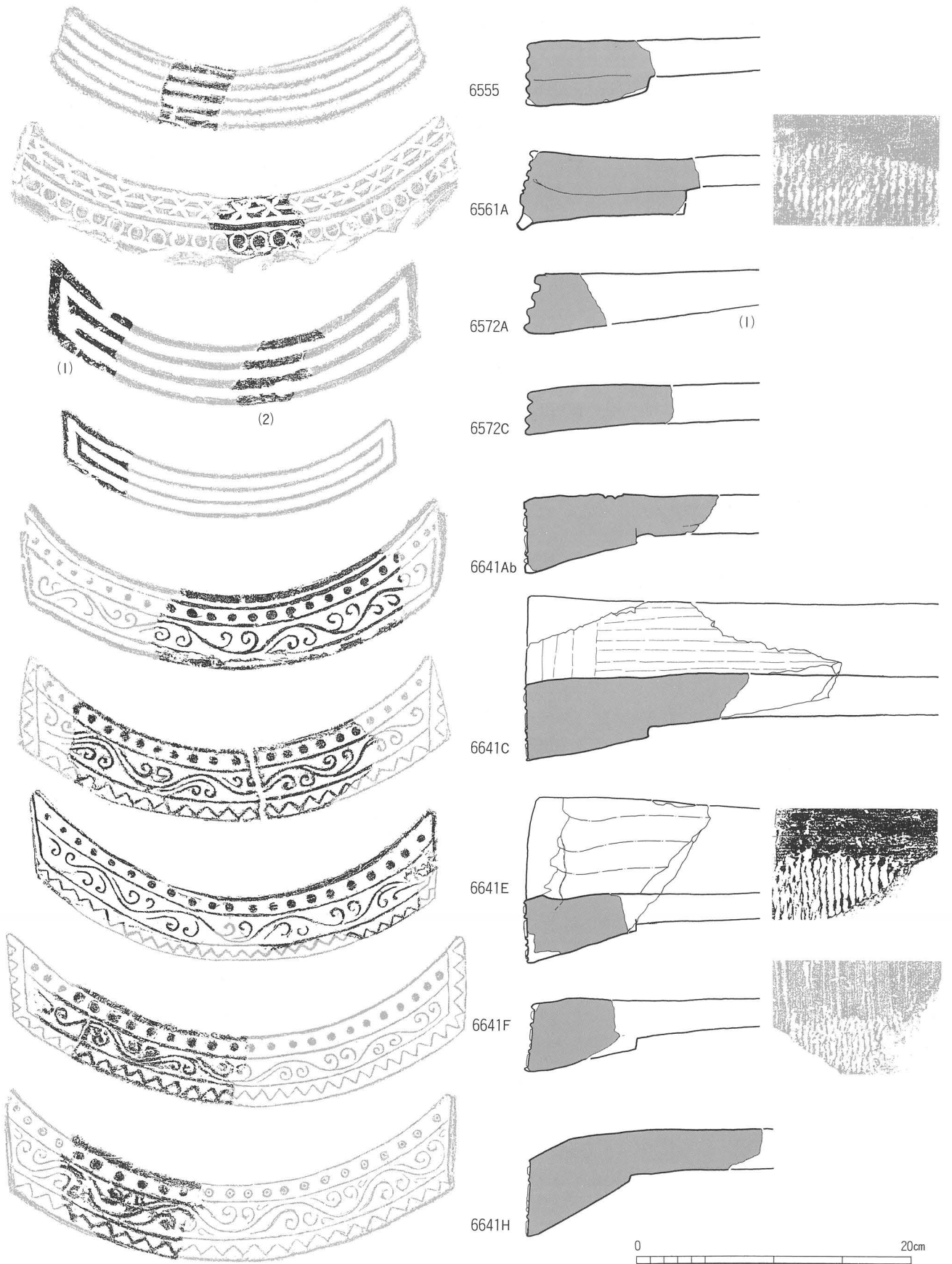

型式・種	最大幅	弧深	厚さ	内区		上外区		下外区		脇区		外縁			顎	形態		
				厚	文様	厚	文様	厚	文様	幅	文様	幅	高さ	形態		全長	段	直
6555															段			—
6561-A	334	60	48	12	G										段			—
6572-A	265	63	45	10	J													—
6572-C	(234)	47	30	10	J													—
6641-Ab			49	21	HK	12	S 23	—		—		8	3		段			—
6641-C	292	64	52	24	HK	13	S 23	14	LV 19	14	LV 4	—	2		段			—
6641-E	314	63	50	24	HK	14	S 21	13	LV 26	—	LV	—	2		段			タテ
6641-F	324	77	50	20	HK	15	S 24	14	LV 26	10	LV 5	—	2.5		段			タテ
6641-H	308	70	54	26	HK	13	S 23	—	LV 21	—		—	2		段			—

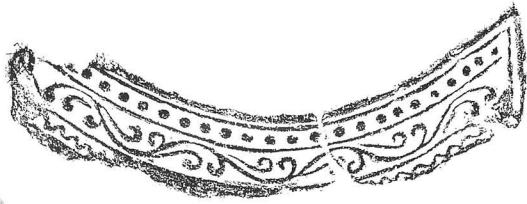
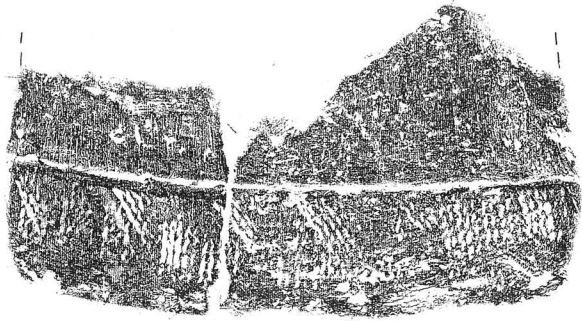
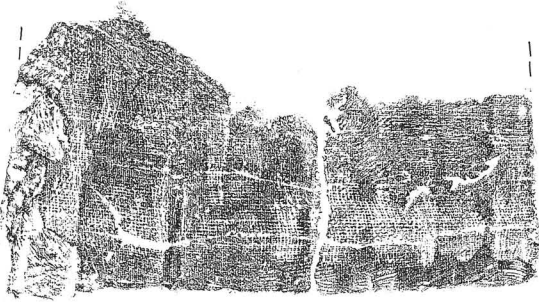

6641P

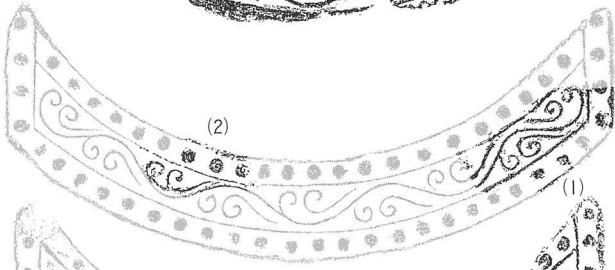
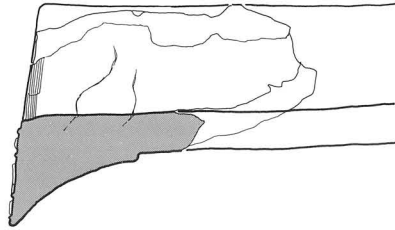

6643C

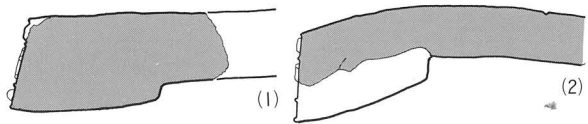

6643D

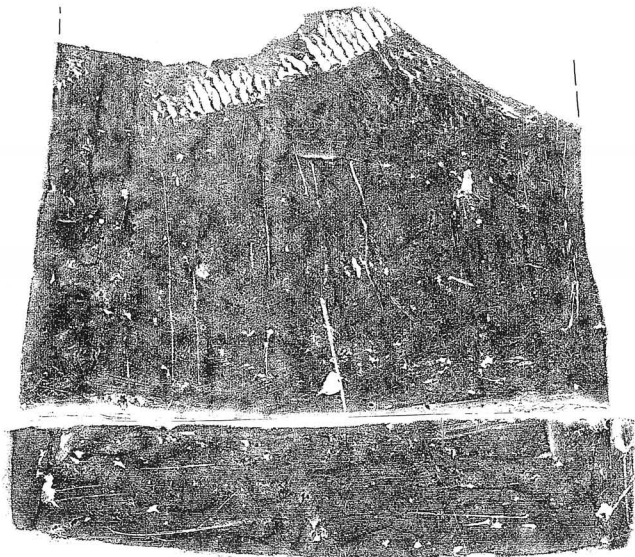
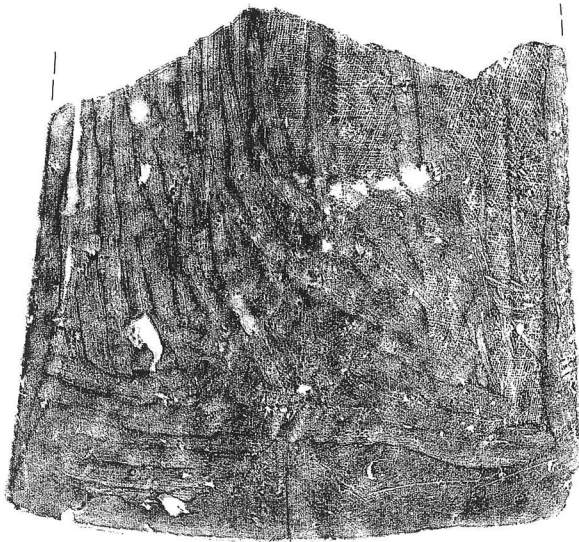

6644A

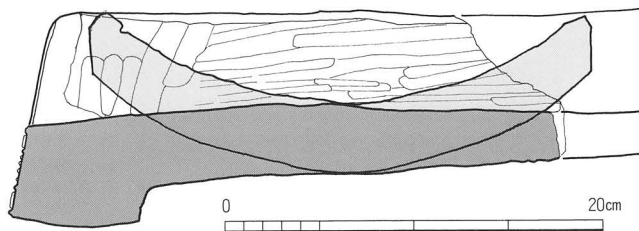

型式・種	最大幅	弧深	厚さ	内区		上外区		下外区		脇区		外縁			顎		形態			叩き方向
				厚	文様	厚	文様	厚	文様	幅	文様	幅	高さ	形態	全長	段	直	曲Ⅰ	曲Ⅱ	
6641-P				21	HK	12	S(?)	12	LV(?)	9		6		なし	383	段			タテ・ナナメ	
6643-C	305	78	51	25	HK	13	S 22	12	S 23	14	S 4	—	5	なし		段			—	
6643-D		60	46	19	HK	12	S	12	S	13	S 4	—	2	なし		段			—	
6644-A	295	56	52	21	HN	12	S 17	14	LV 21	—		—	3	なし	段			ナナメ		
6644-B	255	47	47	14	HN	13	S 15	12	LV 18	—		—	3	なし	段			—		
6644-C			47	13	HN	13	S 17	13	LV(?)	—		—	2	なし	段			—		
6654-A			49	26	KK	11	S(?)	13	LV(?)	14	LV 3	—	1	なし	段			—		

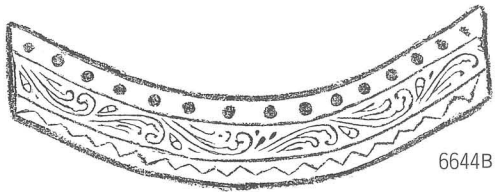

6644B

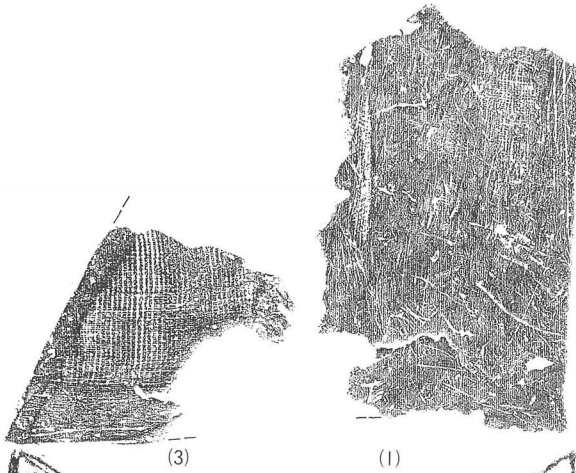
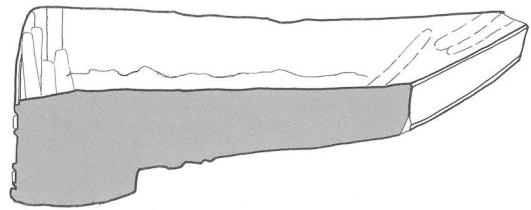

(3)

(1)

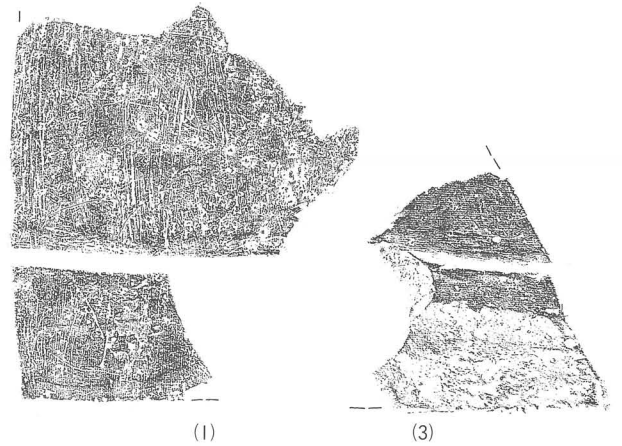

(1)

(3)

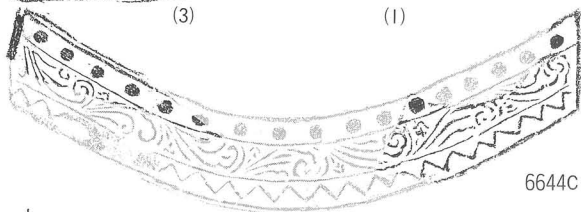

6644C

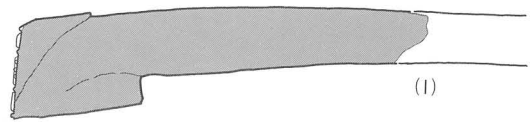

(1)

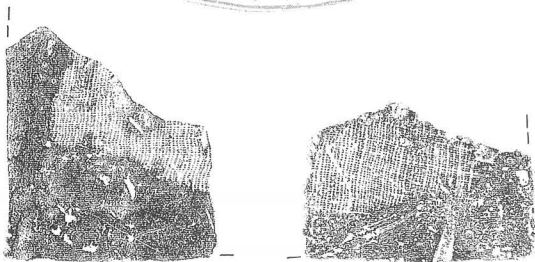

(2)

(1)

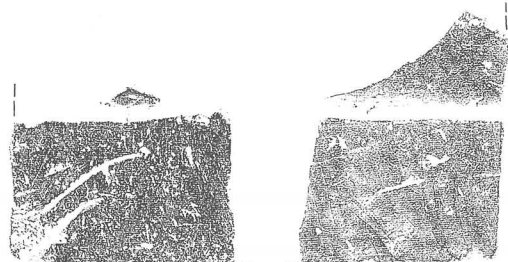

(1)

(2)



6654A

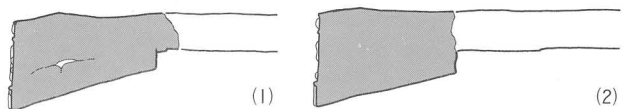

(1)

(2)

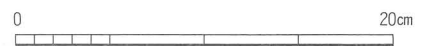

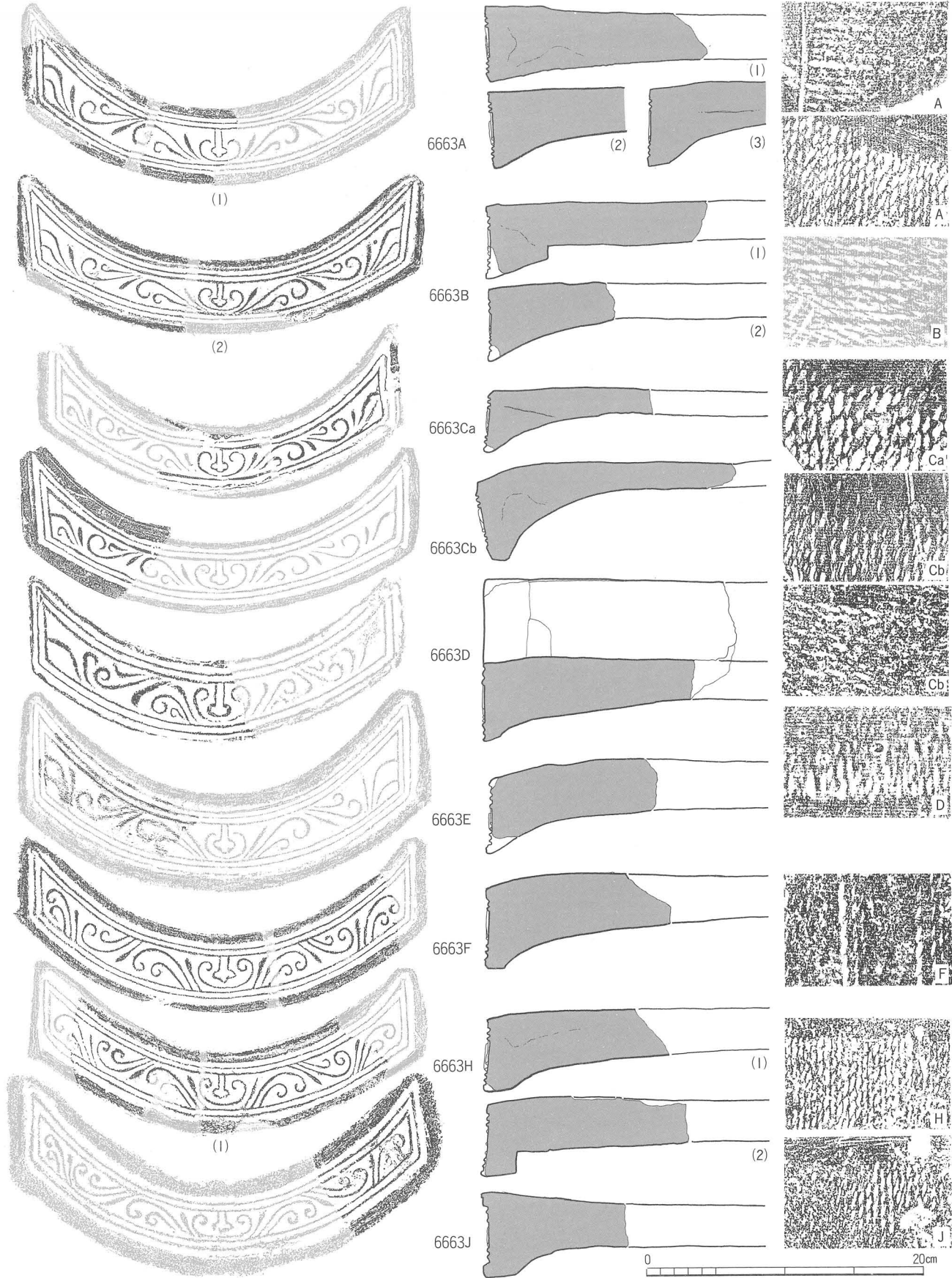

型式・種	最大幅	弧深	厚さ	内区		上外区		下外区		脇区		外縁			顎	形態	叩き方向			
				厚	文様	厚	文様	厚	文様	幅	文様	幅	高さ	形態				全長	段	直
6663-A	284	77	57	27	KK	5	K	4	K	4	K	10	2	1段	253	段	直	曲Ⅰ	曲Ⅱ	タテ・ヨコ
6663-B	283	66	59	23	KK	5	K	4	K	4	K	11	2	1段				曲Ⅰ		タテ・ヨコ
6663-Ca	280	72	53	26	KK	5	K	5	K	6	K	11	3	1段	376	段	直	曲Ⅰ		タテ
6663-Cb	278	72	49	23	KK	4	K	5	K	5	K	7	3	1段				曲Ⅰ		タテ・ヨコ
6663-D	248	60	67	31	KK	6	K	6	K	5	K	9	3	1段	380	段	直		曲Ⅱ	—
6663-E	282	69	67	28	KK	3	K	4	K	4	K	14	3	1段				曲Ⅱ		—
6663-F	290	66	55	30	KK	4	K	4	K	6	K	11	3	1段	380	段	直		曲Ⅱ	タテ
6663-H	290	66	55	25	KK	4	K	4	K	4	K	9	4	1段				曲Ⅱ		タテ
6663-J	290	66	63	23	KK	5	K	6	K	6	K	14	4	1段				曲Ⅱ		タテ

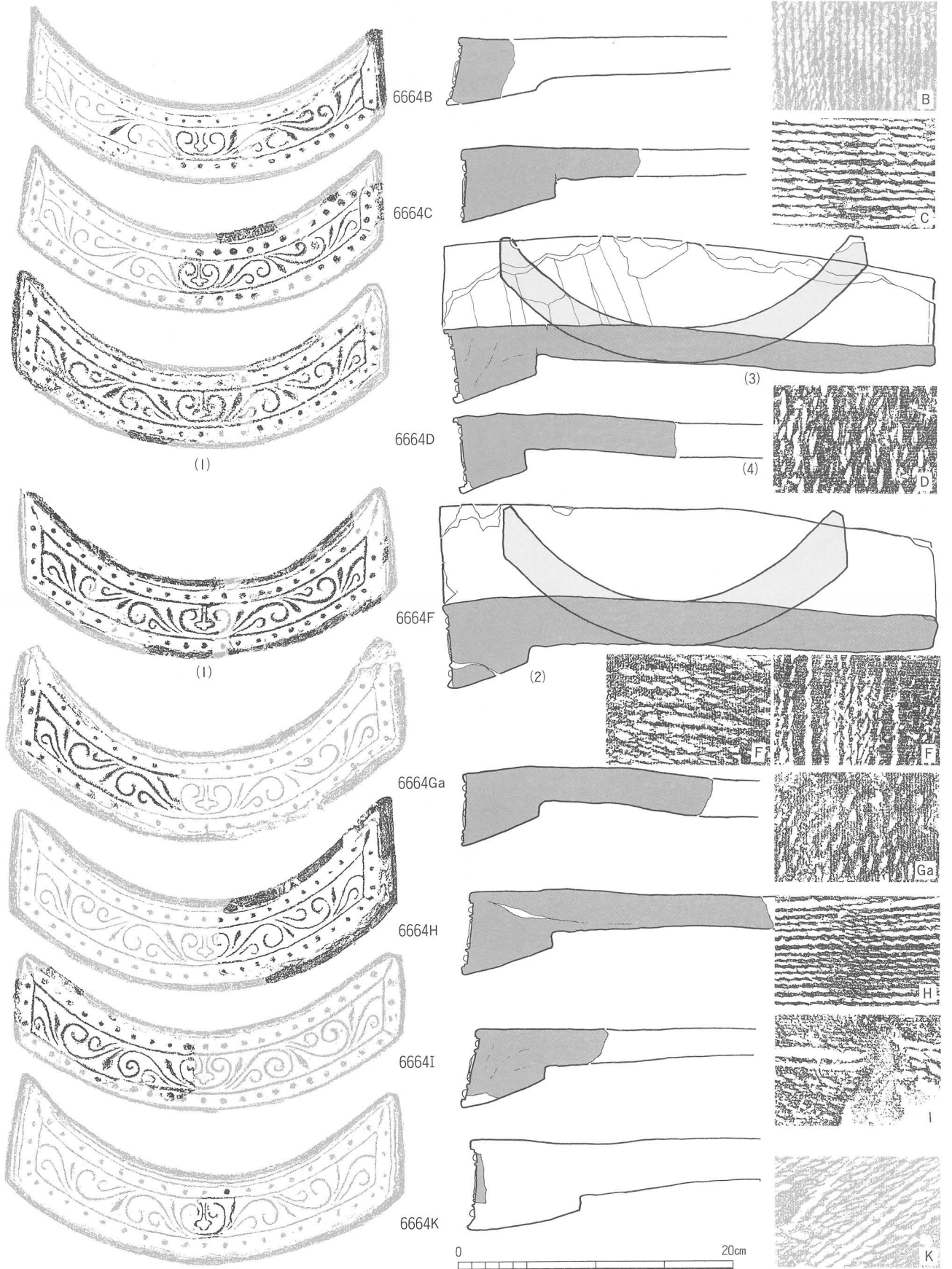

型式・種	最大幅	弧深	厚さ	内区		上外区		下外区		脇区		外縁			顎	形態			叩き方向
				厚	文様	厚	文様	厚	文様	幅	文様	幅	高さ	形態		全長	段	直	
6664-B	245	61	54	24	KK	8	S 21	9	S 21	10	S 3	6	4	2段	376	段			—
6664-C	240	62	51	24	KK	12	S 21	11	S 21	10	S 3	5	4	1段	358	段			ヨコ
6664-D	240	60	60	22	KK	11	S 17	12	S 19	12	S 3	6	5	1段	375	段			タテ
6664-F	245	61	58	27	KK	10	S 19	11	S 21	12	S 3	7	5	1段	371	段			タテ・ヨコ
6664-G	263	80	60	23	KK	11	S 17	9	S 17	11	S 3	6	6	1段	376	段			タテ
6664-H	272	68	57	24	KK	12	S 21	11	S 21	12	S 3	8	6	1段	383	段			ヨコ
6664-I	236	51	52	24	KK	12	S 21	10	S 21	9	S 3	4	4	段なし	400	段			ヨコ
6664-K	265	66	62	28	KK	9	S 17	11	S 19	10	S 4	8	6	段					—

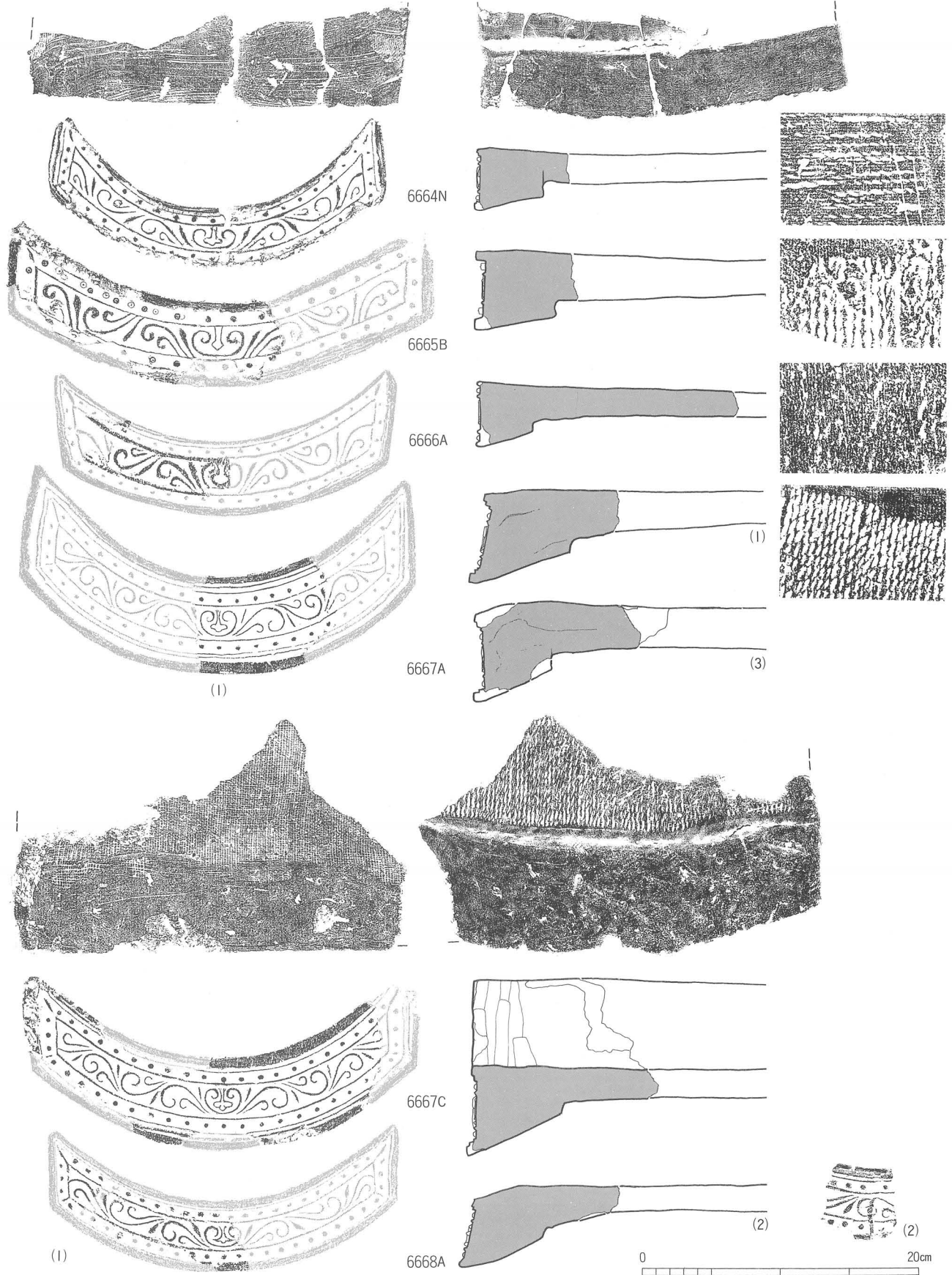

型式・種	最大幅	弧深	厚さ	内 区		上外区		下外区		脇 区		外 縁			顎 形 態				
				厚	文様	厚	文様	厚	文様	幅	文様	幅	高さ	形態	全長	段	直	曲 I	曲 II
6664-N	235	67	44	19	KK	8	S 18	8	S(17)	9	S 4	5	4	1段	321	段			ヨコ
6665-B	296	52	58	23	KK	10	S 15	10	S 15	12	S 3	8	4	段なし		段			タテ
6666-A	222	57	51	22	KK	10	S 19	7	S 18	7	S 3	4	5	段なし		段			タテ
6667-A	269	76	65	25	KK	11	S 21	11	S 21	11	S 3	8	8	2段		段			タテ
6667-C			66	25	KK	11	S(?)	11	S(?)	12	S 3	9		2段		段			タテ
6668-A	244	52	47	22	KK	8	S 22	11	S 23	10	S 3	6	3	1段	段			—	

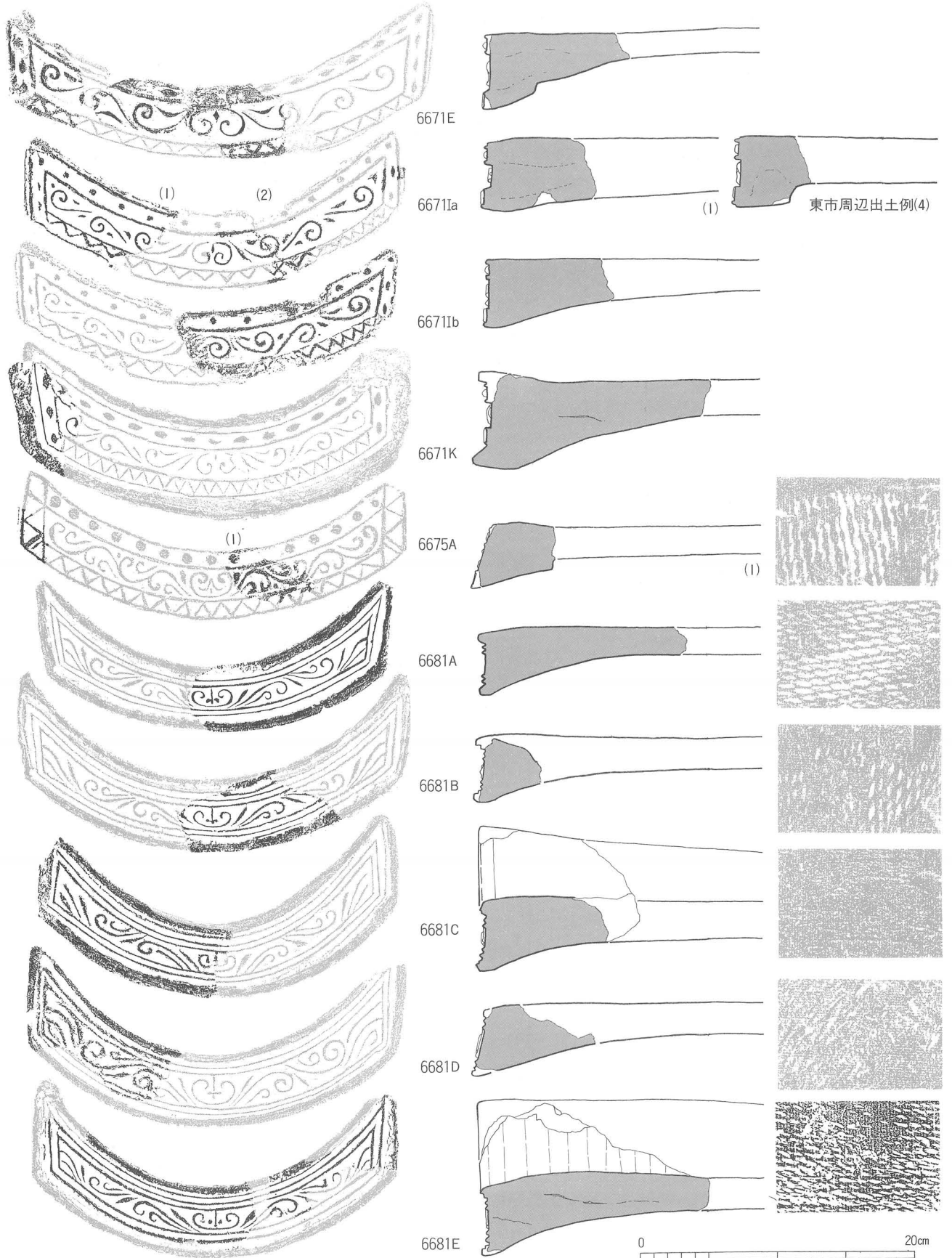

型式・種	最大幅	弧深	厚さ	内区		上外区		下外区		脇区		外縁			顎	形態																																											
				厚	文様	厚	文様	厚	文様	幅	文様	幅	高さ	形態		全長	段	直	曲I	曲II	叩き方向																																						
6671-E			57	31	KK	12	GS(?)	12	LV(?)	15	GS 4	—	—	なし	355	直直	—	—	—																																								
6671-Ia			49	22	KK	14	S(?)	13	LV(?)	10	GS 3	—	—	なし						355	直直	—	—	—																																			
6671-Ib			50	20	KK	14	S(?)	12	LV(?)	12	GS 3	—	3	なし											355	直直	—	—	—																														
6671-K			65	20	KK	13	S(?)	12	LV(?)	12	GS 3	—	—	なし																355	直直	—	—	—																									
6675-A	267	59	49	26	KK	12	S 15	14	LV 17	16	LV 1	—	1	なし																					355	直直	—	—	—																				
6681-A	250	60	45	18	KK	5	K	4	K	4	K	11	5	なし																										355	直直	—	—	ヨコ															
6681-B	274	80	55	22	KK	6	K	7	K	7	K	14	3	2段																															355	直直	—	—	ヨコ										
6681-C	253	73	49	18	KK	6	K	5	K	5	K	17	3	2段																																				355	直直	—	—	ヨコ					
6681-D	250	62	60	26	KK	6	K	5	K	5	K	19	6	1段																																									355	直直	—	—	ヨコ
6681-E	262	64	47	17	KK	7	K	6	K	6	K	17	7	2段																																													

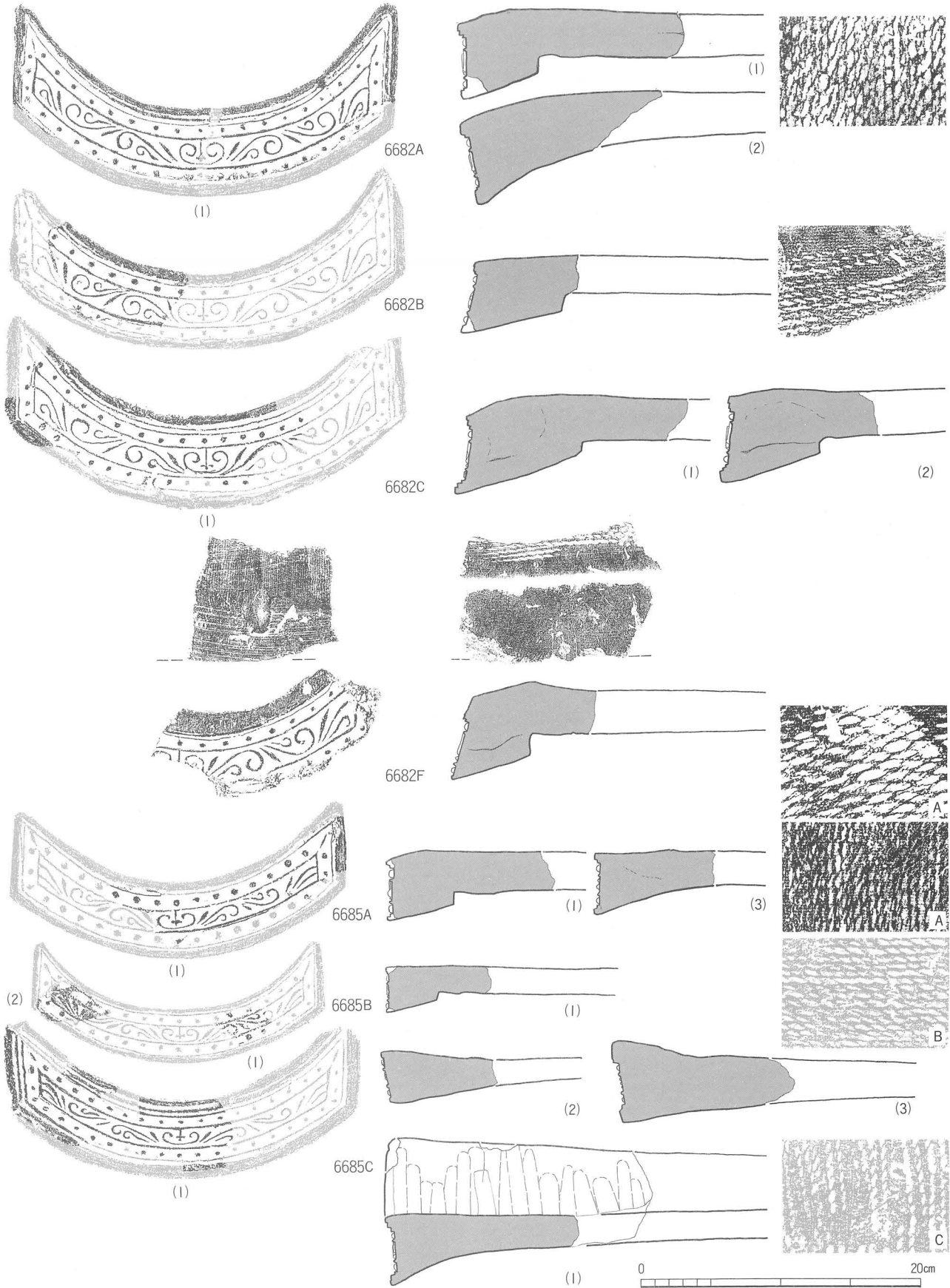

型式・種	最大幅	弧深	厚さ	内区		上外区		下外区		脇区		外縁			顎全長	形態			
				厚	文様	厚	文様	厚	文様	幅	文様	幅	高さ	形態		段	直	曲 I	曲 II
6682-A	264	78	52	24	KK	10	S 17	10	S 17	11	S 3	19	5	2段	350	直	曲 I		タテ
6682-B			47	19	KK	10	S(?)	9	S	9	S 3	10	5	2段					ヨコ
6682-C			60	20	KK	8	S 19	9	S(?)	11	S(4)	12	5	2段					—
6682-F				21	KK	9	S(?)		S(?)		S(?)	11	6	2段					ヨコ
6685-A	222	52	47	16	KK	11	S 15	17	S 15	11	S 2	7	4	2段	339		曲 I		タテ・ヨコ
6685-B	200	51	38	13	KK	9	S 15	10	S 15	11	S 1	6	4	2段	327				—
6685-C	235	54	52	20	KK	9	S 17	9	S 17	10	S 2	12	5	2段		直	曲 I		タテ

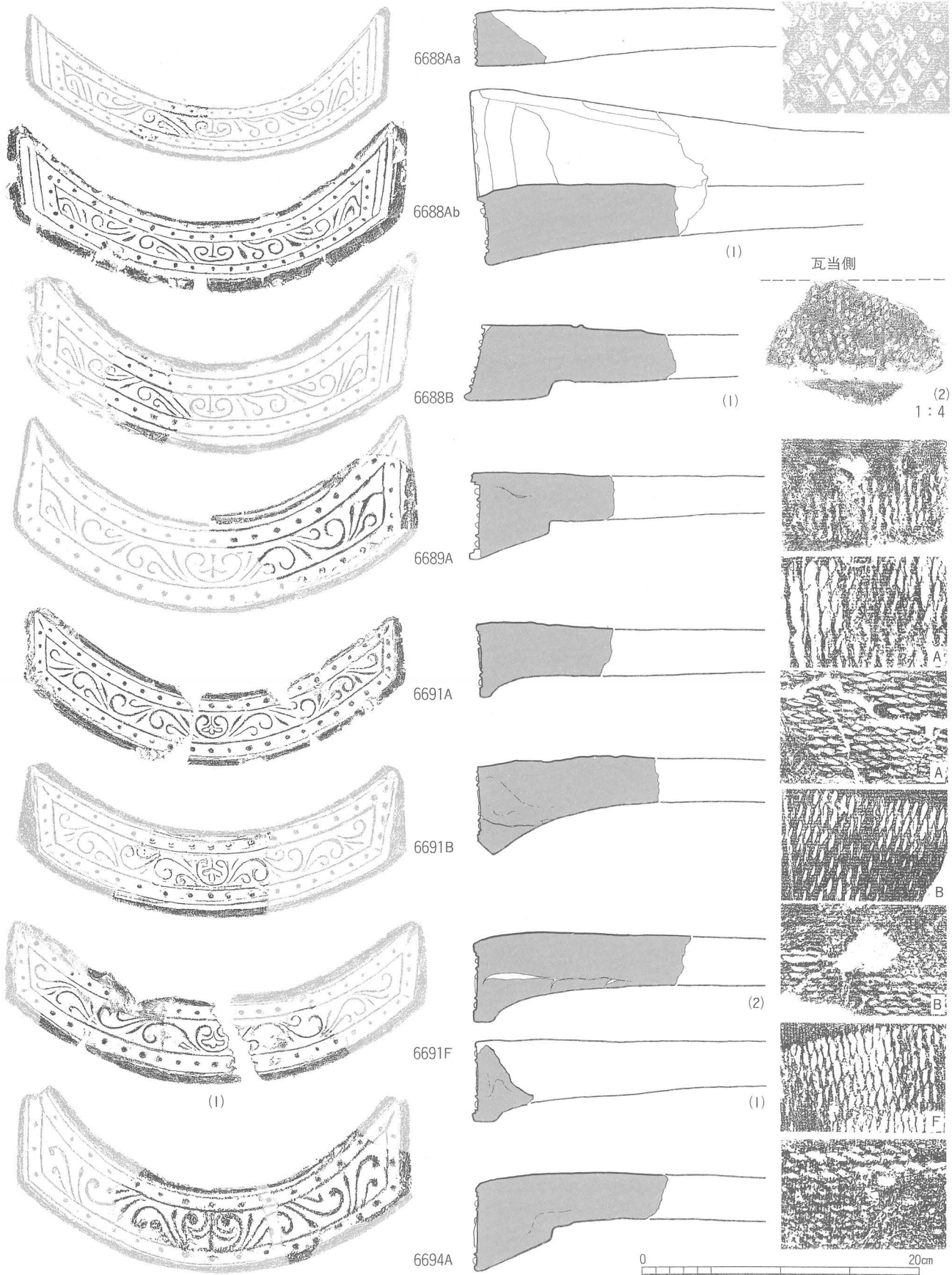

型式・種	最大幅	弧深	厚さ	内区		上外区		下外区		脇区		外縁			顎形態					
				厚	文様	厚	文様	厚	文様	幅	文様	幅	高さ	形態	全長	段	直	曲Ⅰ	曲Ⅱ	叩き方向
6688-Aa	279	71	44	19	KK	9	S 17	9	S 19	11	SL5 SR4K	9	3	1段	359					
6688-Ab	295	69	52	18	KK	8	S 17	8	S 19	11	SL5 SR4K		4	1段		直				
6688-B	280	74	50	16	KK	11	S 17	11	S 16	12	SL5 SR4K		5	1段						
6689-A	268	77	62	28	KK	13	S 17	11	S 17	15	S 3		8	1段						格子
6691-A	286	55	55	25	KK	9	S 21	10	S 21	10	S 3	12	4	1段	345			曲Ⅱ	タテ・ヨコ	
6691-B	257	57	64	27	KK	10	S 17	11	S 16	11	S 3		0	1段			曲Ⅱ	タテ・ヨコ		
6691-F				25	KK	11	S(?)	19	S(?)	9	S 3		3	1段			曲Ⅱ	タテ		
6694-A	235	67	60	32	KK	9	S 15	10	S 14	9	S 3		4	2段	395	段			タテ・ヨコ	

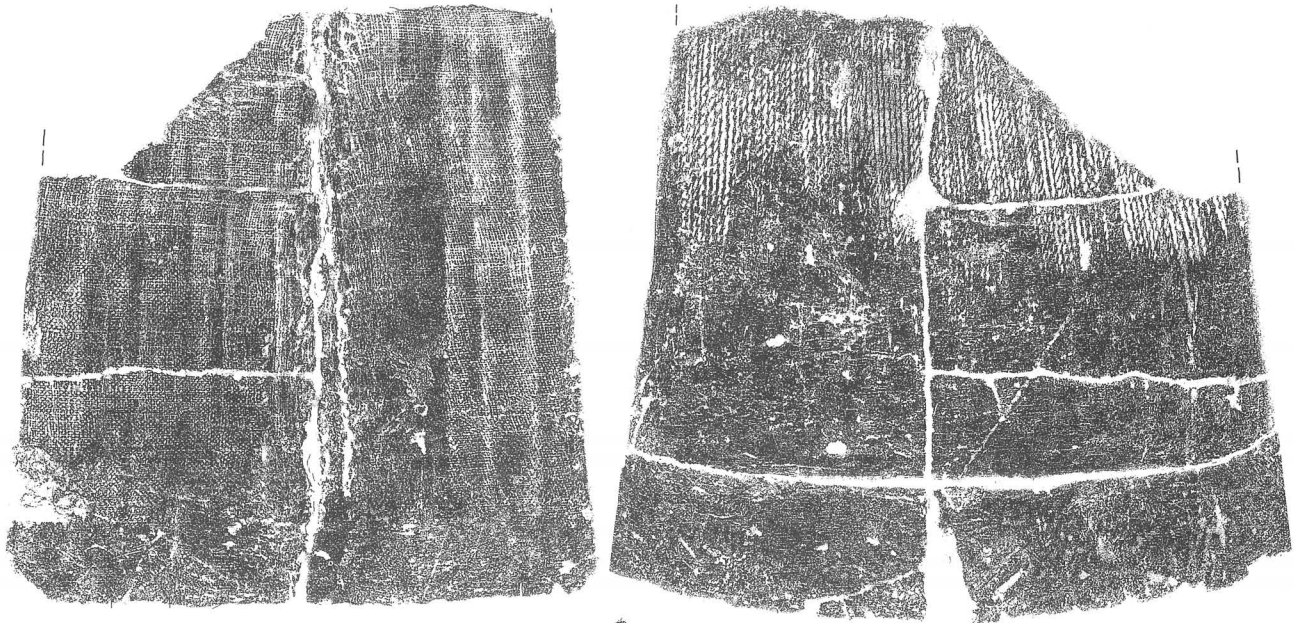

(1)

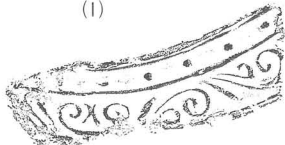

(2)

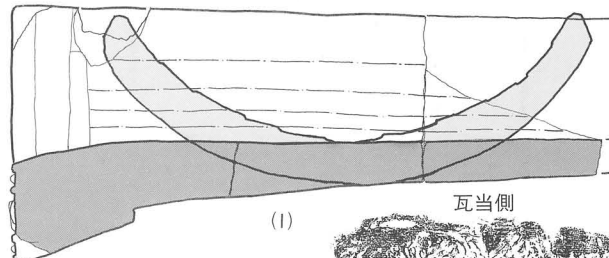
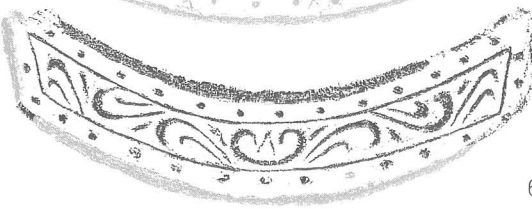
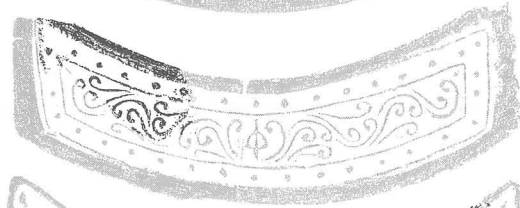
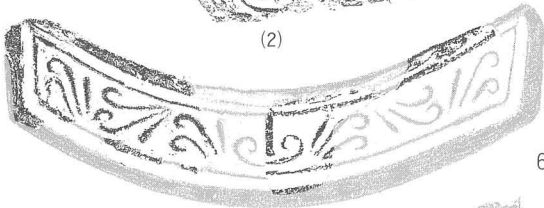

(1)

6700A

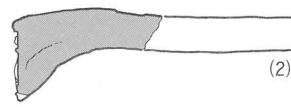

(2)

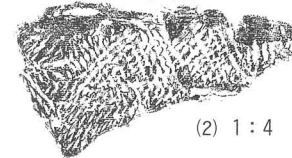

(2) 1:4

6702A

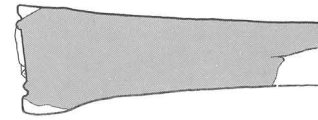

6704A

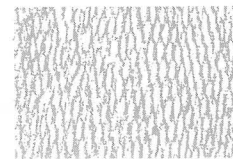
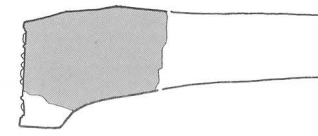

6710A

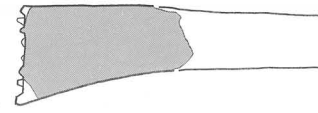

6710C

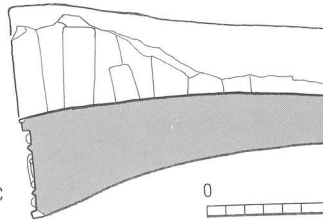

型式・種	最大幅	弧深	厚さ	内区		上外区		下外区		脇区		外縁			顎形態				
				厚	文様	厚	文様	厚	文様	幅	文様	幅	高さ	形態	全長	段	直	曲Ⅰ	曲Ⅱ
6700-A	290	73	50	25	KK	11	S(13)	7	S(?)	10	S 3	4	3	1段			曲		タテ
6702-A	280	40	64	34	KK	12		18		16		9.5	3	段なし	360			曲Ⅱ	タテ
6704-A	260	42	66	28	KK	9	S 13	9	S 13	8.5	S(?)	8.5	3	1段			曲Ⅱ		—
6710-A	264	55	56	22	KK	9	S13×4	10.5	S13×4	8.7	S 3	3	4	段なし	347		直		—
6710-C	266	48	55	25	KK	9	S 12	9	S 13	18	S 3	5	5	1段	355		直		—

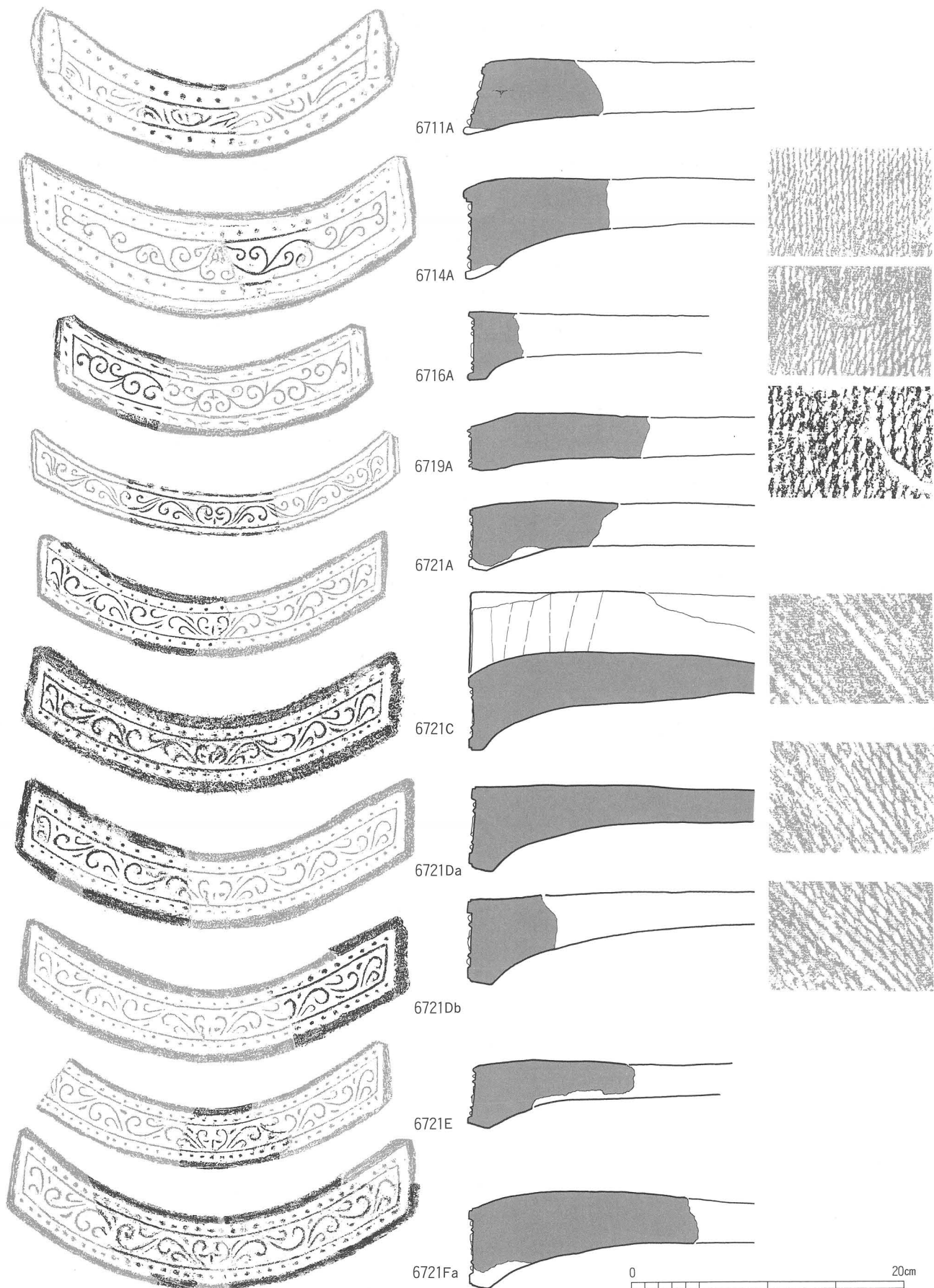

型式・種	最大幅	弧深	厚さ	内区		上外区		下外区		脇区		外縁			顎		形態			
				厚	文様	厚	文様	厚	文様	幅	文様	幅	高さ	形態	全長	段	直	曲Ⅰ	曲Ⅱ	叩き方向
6711-A	267	63	49	20	KK	11	S 20	15	S 18	21	S 3	5	6	范						—
6714-A	281	48	72	30	KK	9	S 20	10	S 18	10.5	S 4	8	3	1段	320			曲Ⅱ	—	
6716-A	217	28	49	24	KK	7	S 17	6.5	S 17	7	SL3 SR2	4.5	3	段なし				曲Ⅱ	—	
6719-A	287	49	32	22	KK	0.5	1	0.5	1	9	1	4.5	2	なし	370		直		タテ	
6721-A	260	54	45	21	KK	6	S 26	6	S 27	3		5.5	3	范	365			曲Ⅱ	ナナメ	
6721-C	265	49	53	25	KK	6	S 26	6.5	S 32	3		11	3	范	359			曲Ⅱ	ナナメ	
6721-D	272	54	53	22	KK	6.5	S 26	7	S 32	4.5		9	3	范				曲Ⅱ	ナナメ	
6721-E	258	54	42	22	KK	5.5	S 31	6.5	S 35	3.5		5	2	范	395			曲Ⅱ	ナナメ	
6721-Fa	289	65	52	26	KK	7	S 33	6.5	S 34	6		6	3	范				曲Ⅱ	ナナメ	

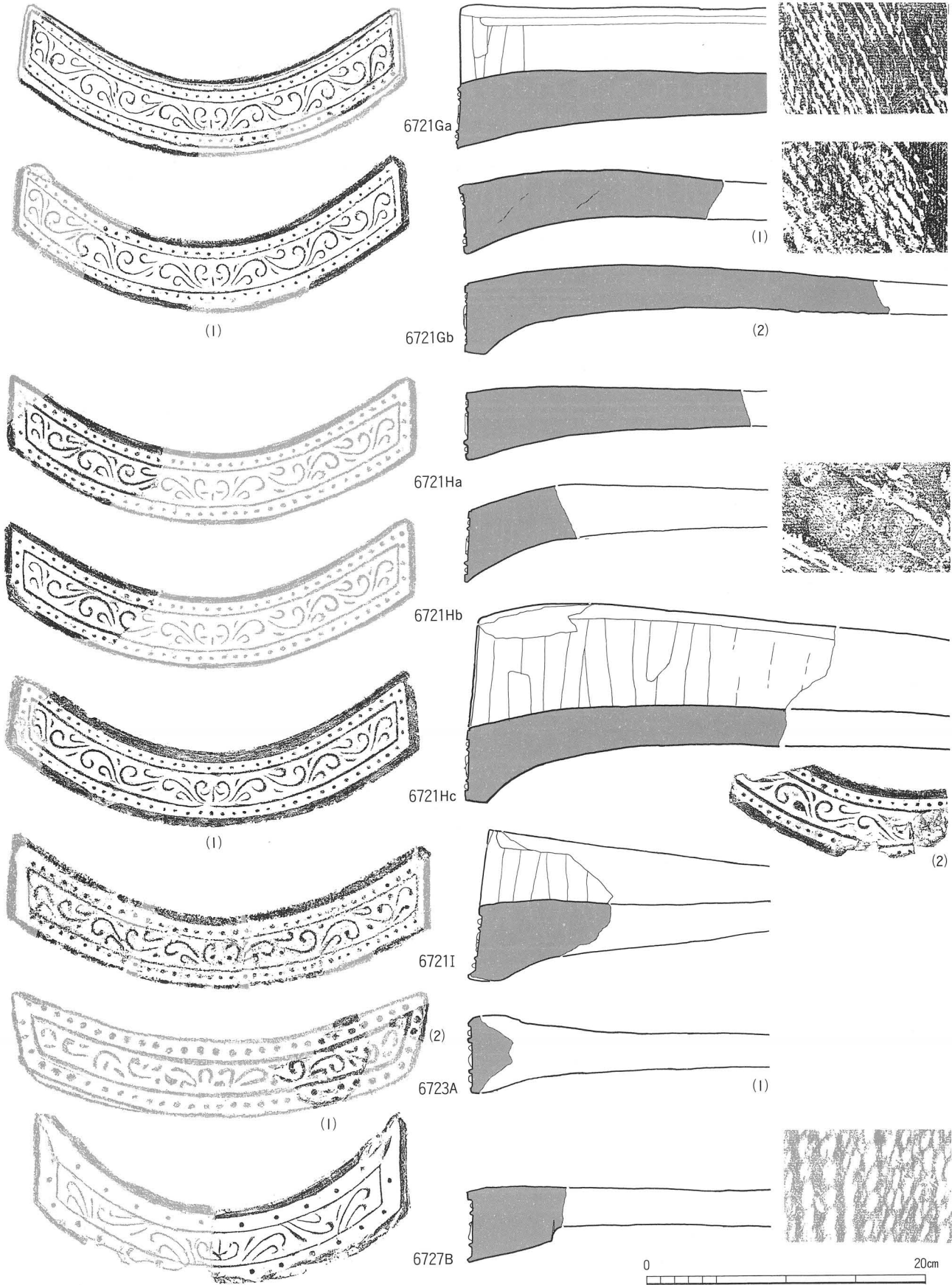

型式・種	最大幅	弧深	厚さ	内区		上外区		下外区		脇区		外縁			顎	形態			
				厚	文様	厚	文様	厚	文様	幅	文様	幅	高さ	形態		全長	段	直	曲 I
6721-Ga	260	60	47	24	KK	7.5	S 34	7.5	S 35	4.5		4	3	範	368	直			ナナメ
6721-Gb	260	60	47	24	KK	6	S 34	7	S 35	3.5		4.5	3	範	368	直		曲 II	ナナメ
6721-Ha	285	69	51	21	KK	8.5	S 33	8	S 34	7	S 3	4.5	3	範		直			ナナメ
6721-Hb	285	69	51	21	KK	7	S 33	7.5	S 34	7	S 3	6.5	3	範		直	曲 I		ナナメ
6721-Hc											S 3	4.7	3	範				曲 II	ナナメ
6721-I	272	49	52	22	KK	15	S 33	15	S 36		S 3							曲 II	一
6723-A	281	36	50	22	KK	9	S 26	12	S 26	9	S 3	4	4	なし		直			一
6727-B	266	78	55	25	KK	11	S 10	9	S 13?	18	S 1	6	5	1段		段			タテ

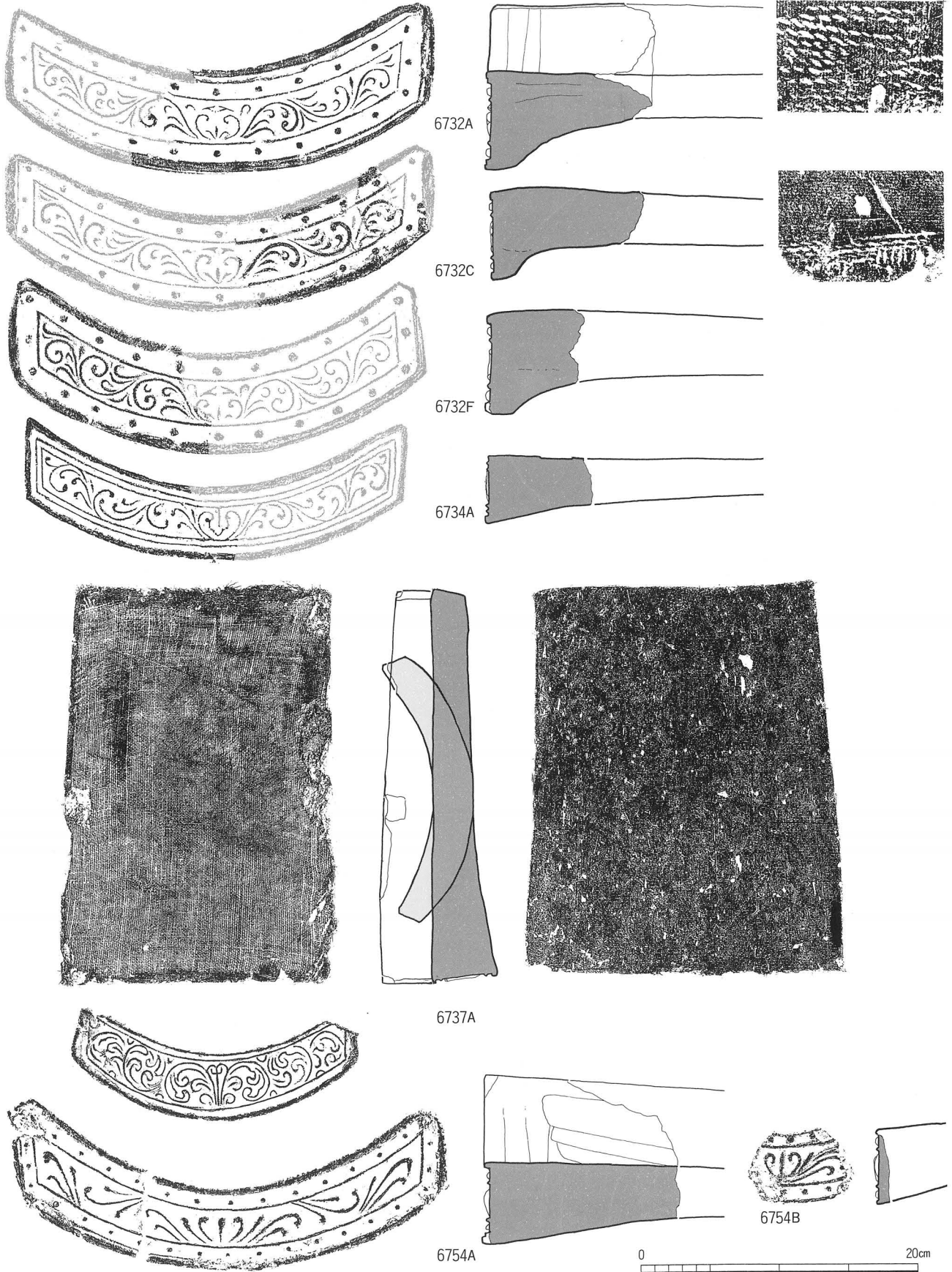

型式・種	最大幅	弧深	厚さ	内区		上外区		下外区		脇区		外縁			顎	形態	全長	段	直	曲Ⅰ	曲Ⅱ	叩き方向
				厚	文様	厚	文様	厚	文様	幅	文様	幅	高さ	形態								
6732-A	285	47	69	36	KK	7.5	S 9	11	S 9	12	S 3	7.5	4	1段	382						タテ・ヨコ	
6732-C	305	44	60	30	KK	3.5	S 9	9.5	S 9	10.5	S 3	8.5	3	段なし	397						タテヨコ	
6732-F	295	33	71	32	KK	16	S 9	19	S(?)	—	S 3	4	4	段なし								
6734-A	262	53	48	26	KK	4	K	3	K	—	K	11	3	段なし	286		直				—	
6737-A	(190)	(30)	46	33	KK	4		8		—		2.5	2	段なし	286		直				—	
6754-A	(307)	64	58	26	KK	9.5	S 13	8.5	S 13	8.5	S 3	5	6	段なし			直				—	
6754-B																		直?				

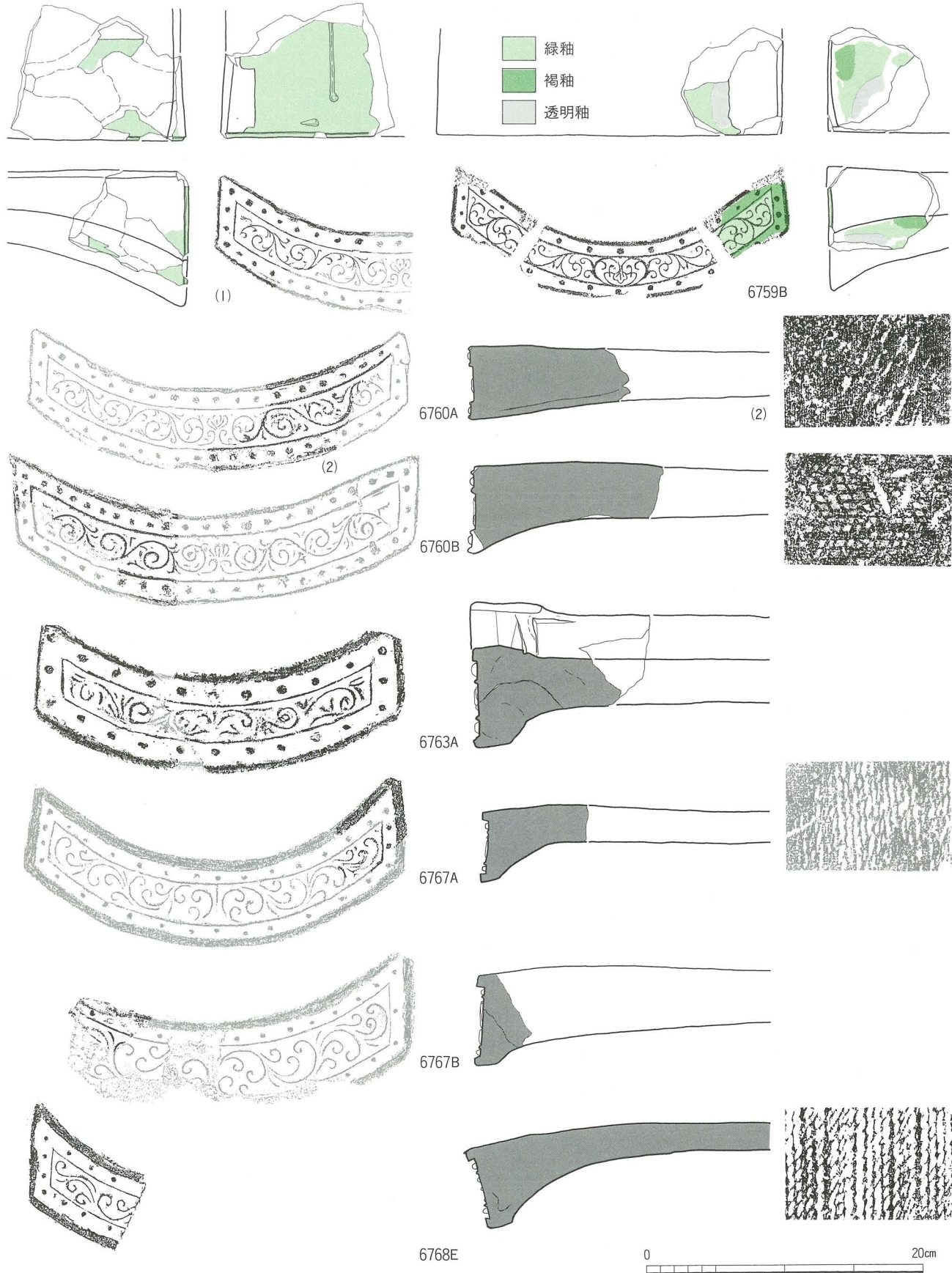

型式・種	最大幅	弧深	厚さ	内区		上外区		下外区		脇区		外縁			顎形態				
				厚	文様	厚	文様	厚	文様	幅	文様	幅	高さ	形態	全長	段	直	曲Ⅰ	曲Ⅱ
6759-B				22	KK		S(?)		S(?)	11	S 2	3.5	5	なし	313	直	曲Ⅰ		—
6760-A	246	41	54	25	KK	10	S 17	10	S 19									曲Ⅰ	
6760-B	280	45	60	25	KK	10	S 20	9	S 18	11	S 4	3.5	3	なし			曲Ⅰ		格子(細)
6763-A	(272)	31	71	26	KK	13	S 8	12	S 9	16	S 3	8.5	5	段なし				曲Ⅱ	タテ
6767-A				22	KK	8.5	S 13	7.5	S 12	8	S 4	8.5	5	段なし				曲Ⅱ	—
6767-B			66	36	KK	7.5	S(?)	7.5	S(?)	7	S 3	7		段なし				曲Ⅱ	—
6768-E			59	24	KK	9	S(?)	11	S(?)	9	S 4	7	7	1段				曲Ⅱ	タテ

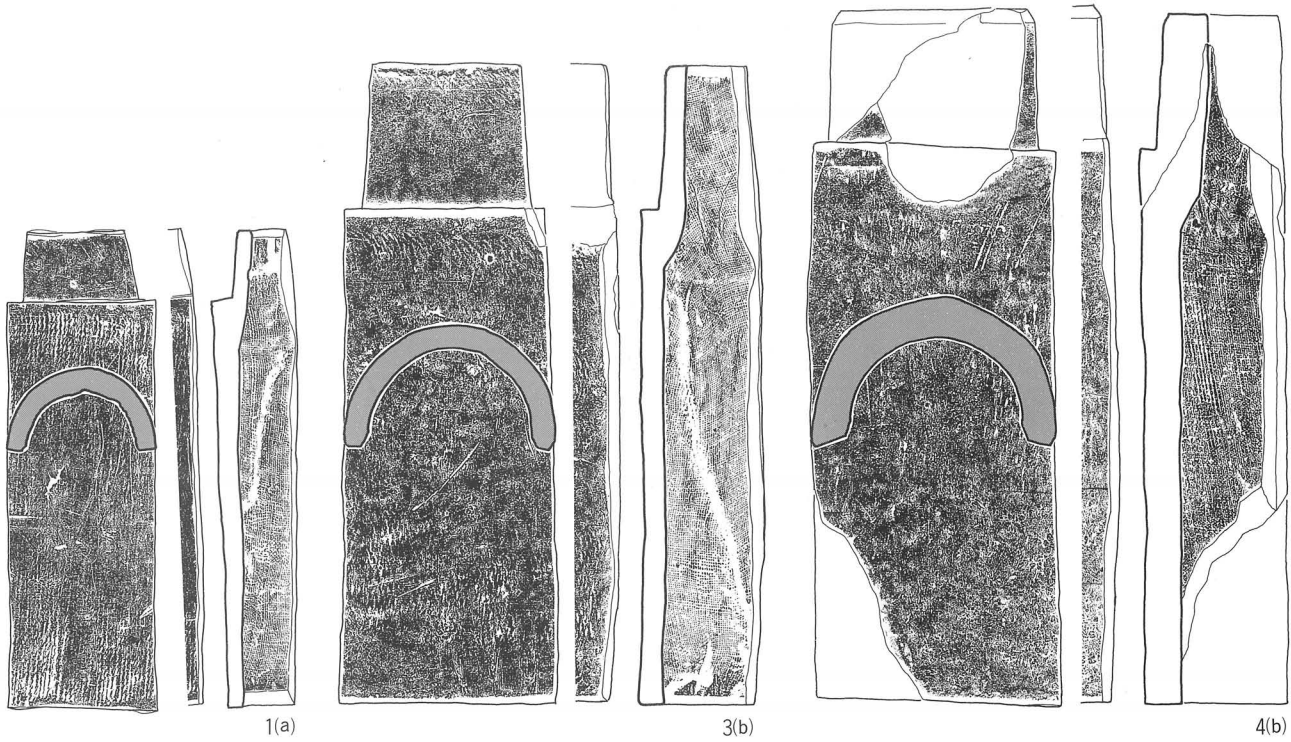

1(a)

3(b)

4(b)

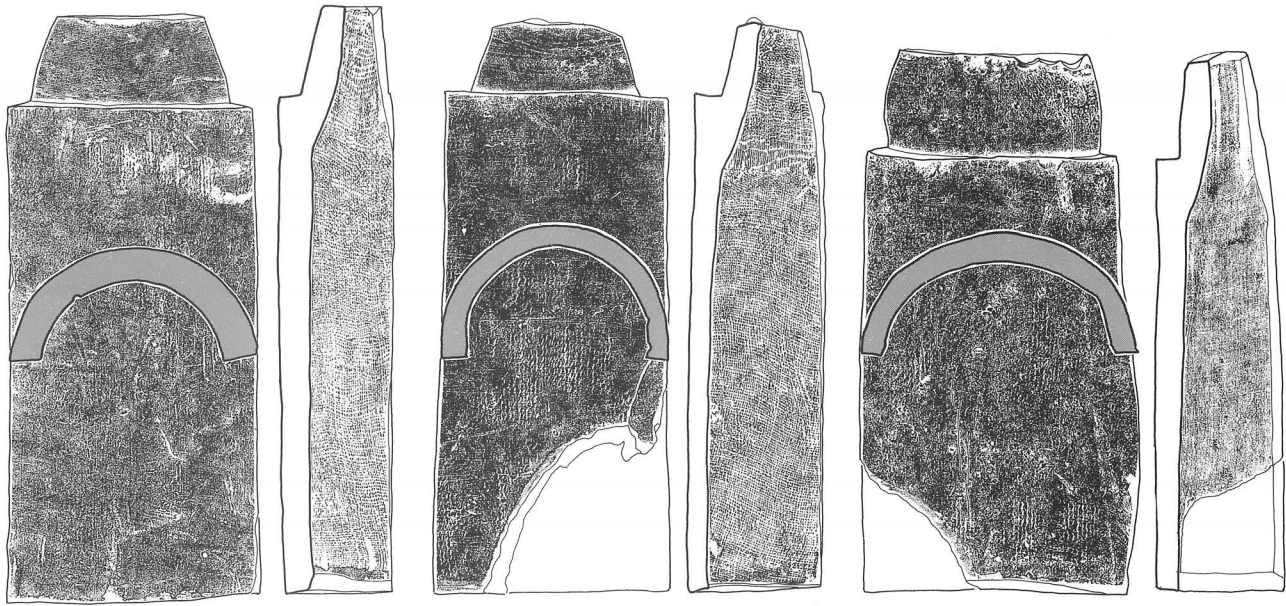

6(c)

7

8

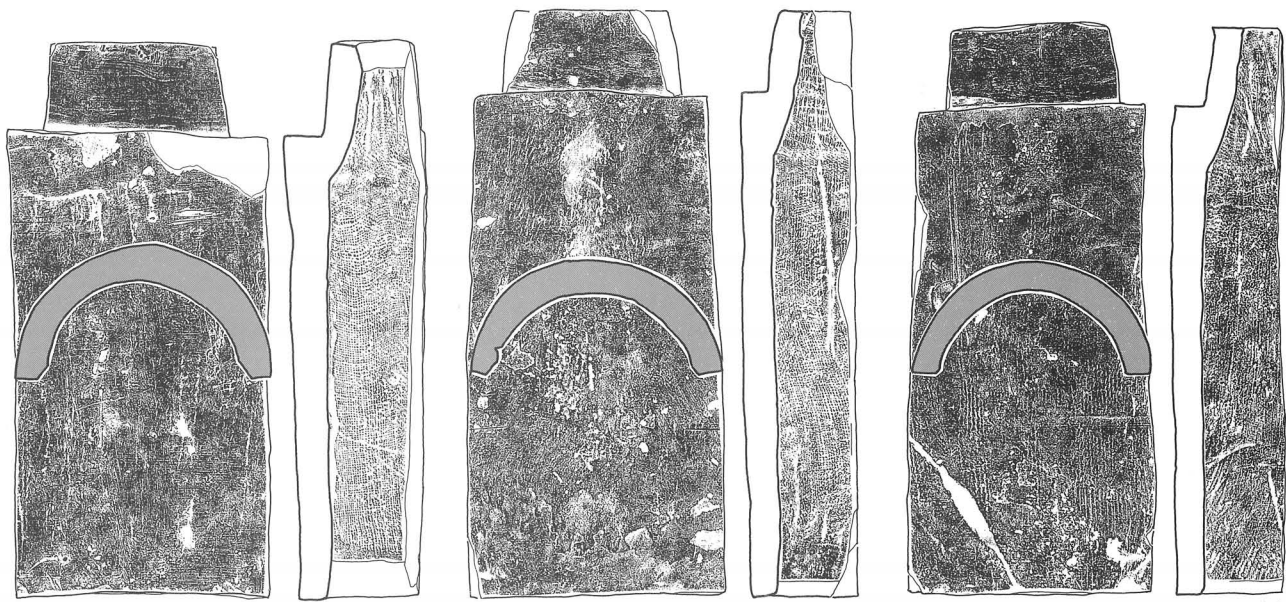

9

11(c)

15(c)

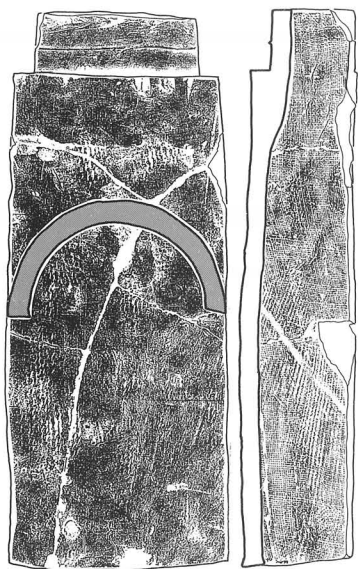

19(e)

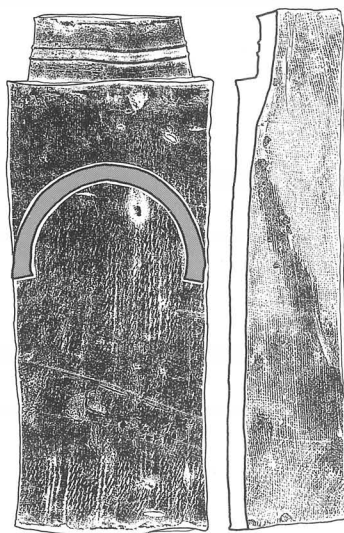

22

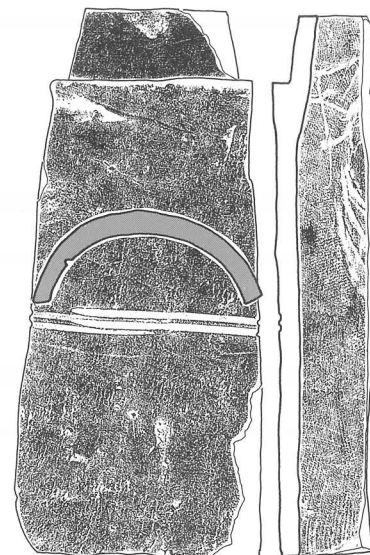

23

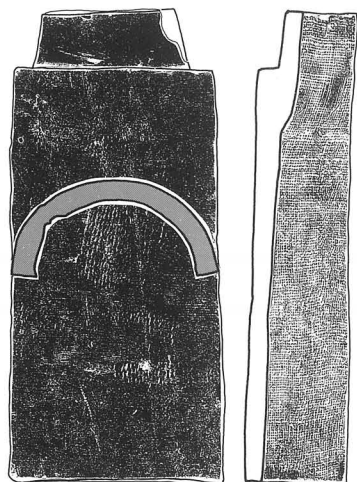

27

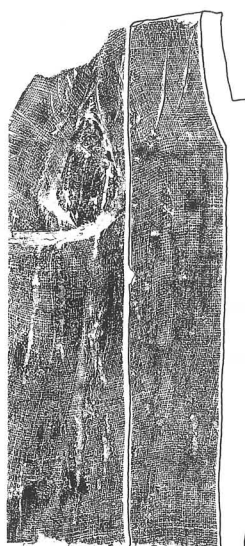

30(d)

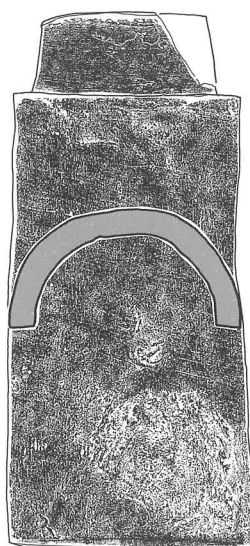

34(d)

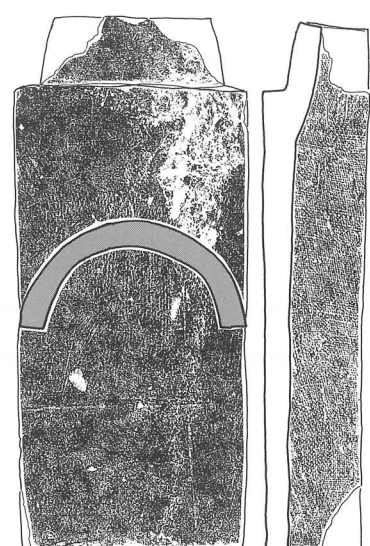

37(d)

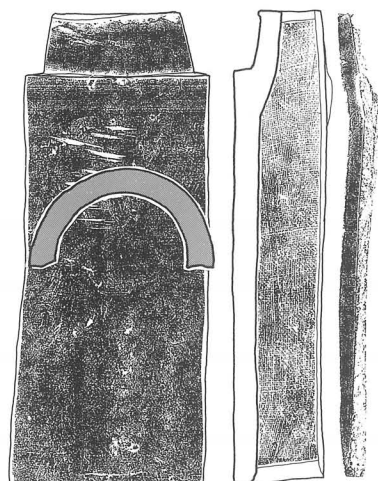

40

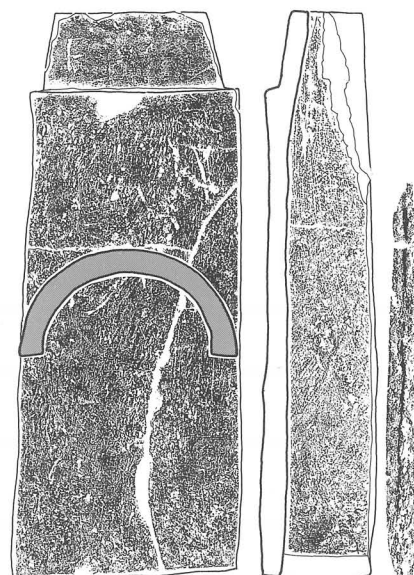

41(d)

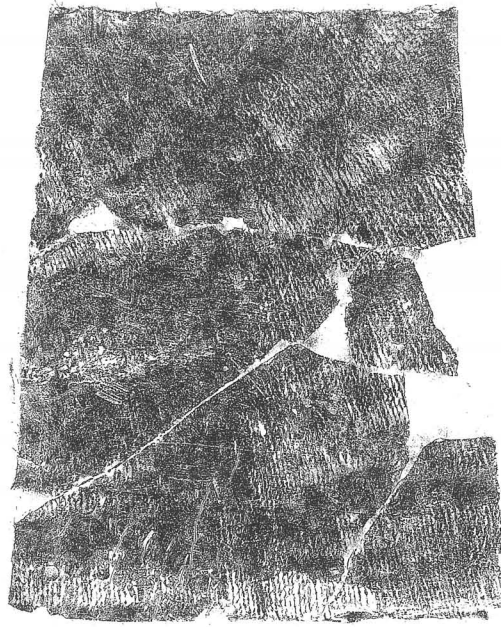
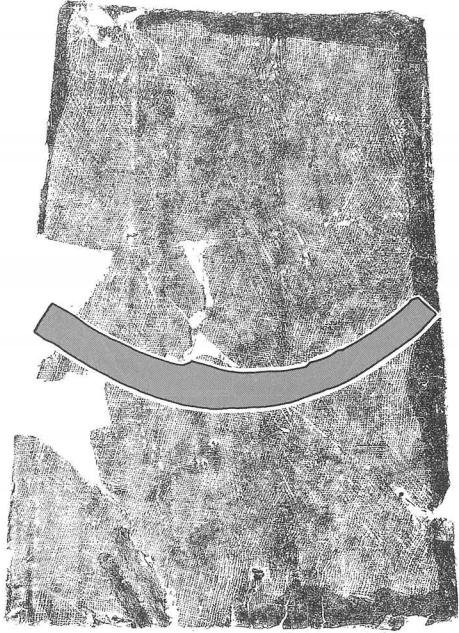

2(a)

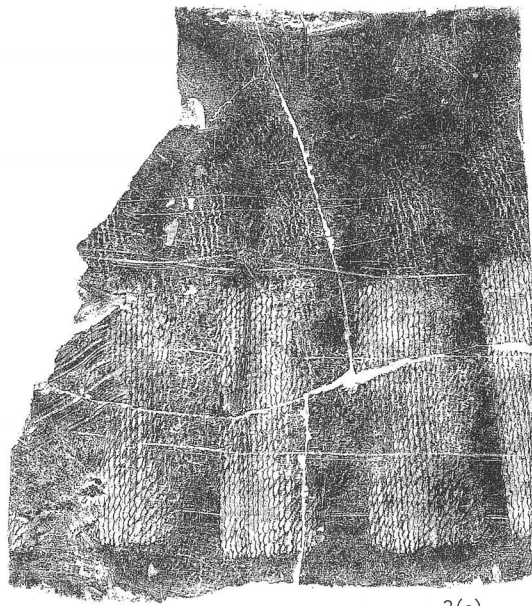
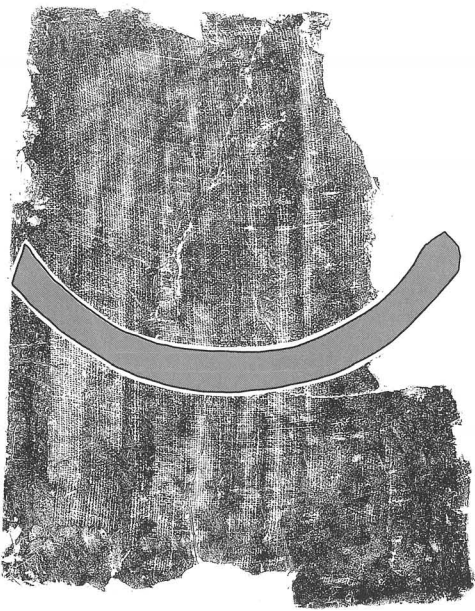

3(a)

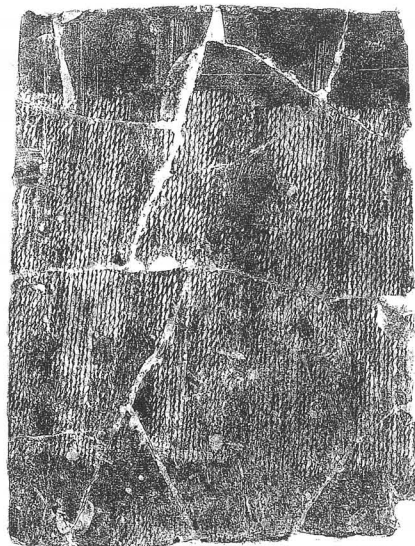
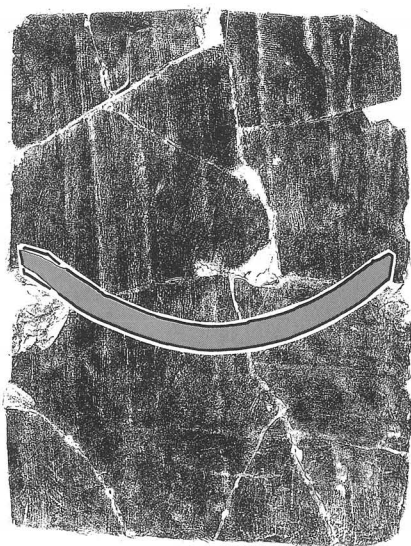

5(b)

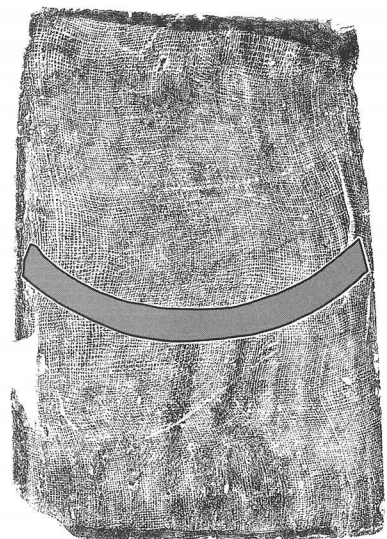

22(e1)

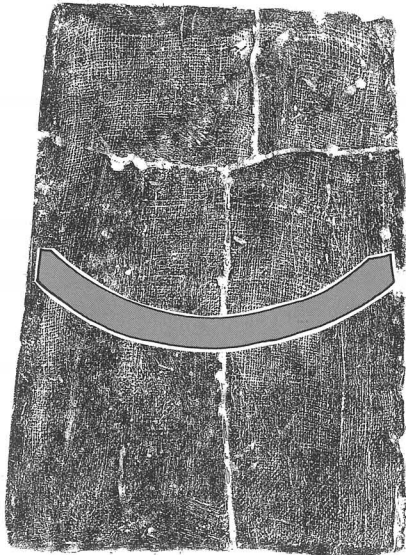

25(e₂)

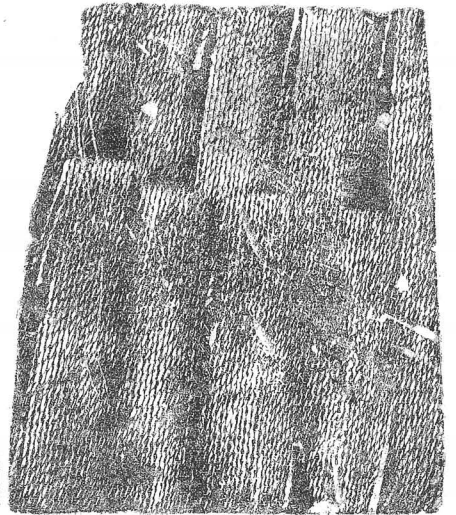
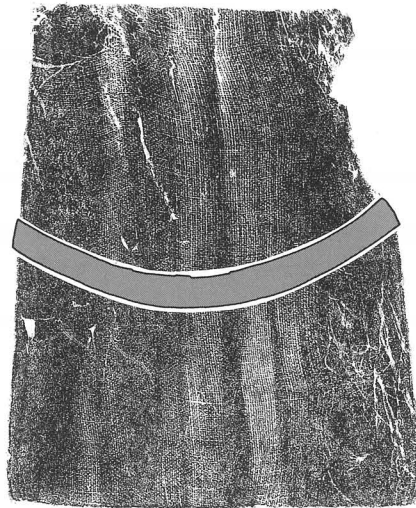

10(c)



25(e₂)

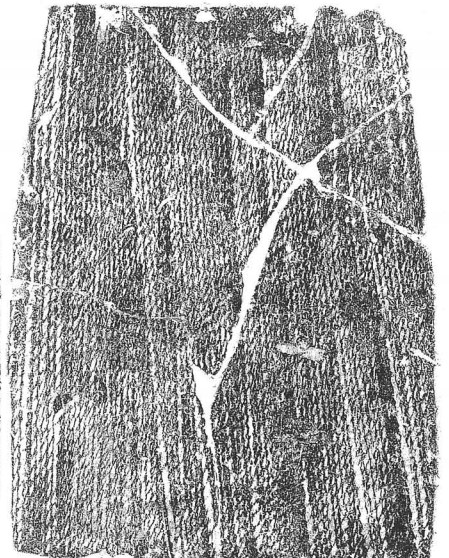
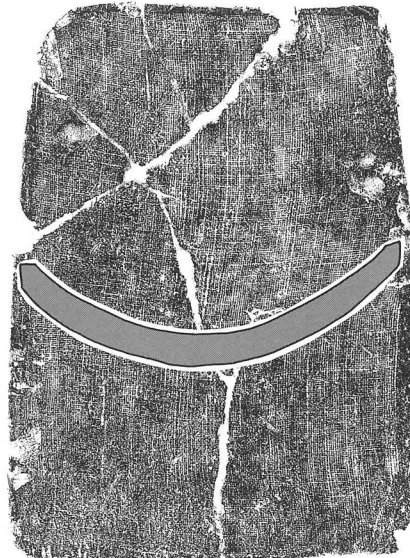

15(d)

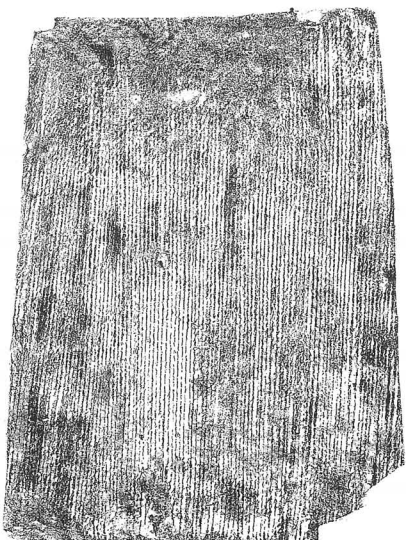

22(e₁)

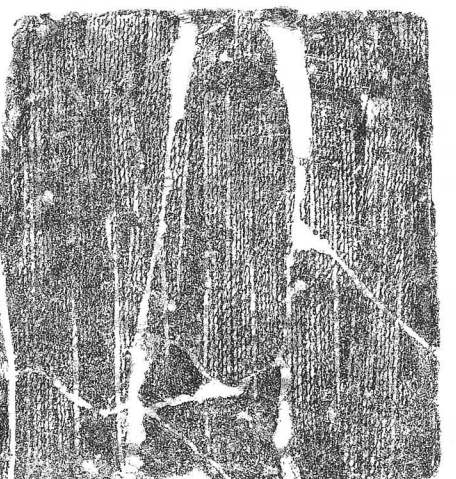
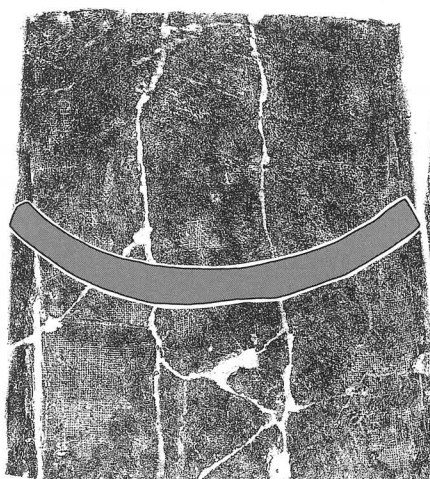

27(f)

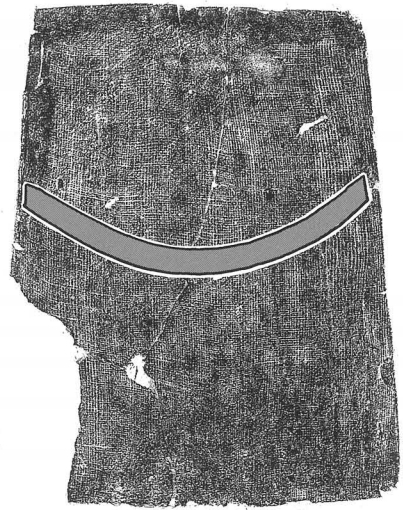
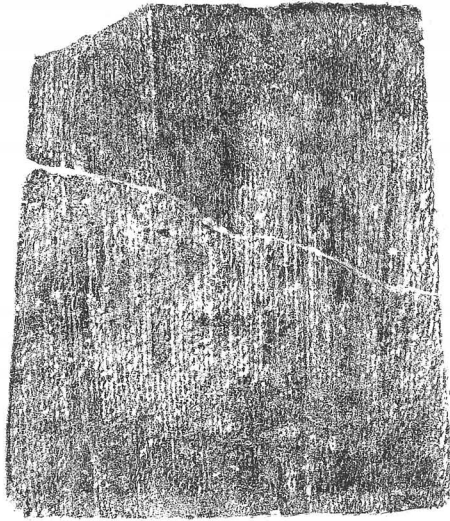
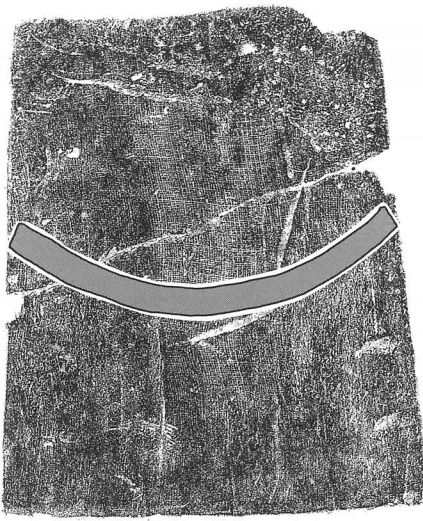

33(g)

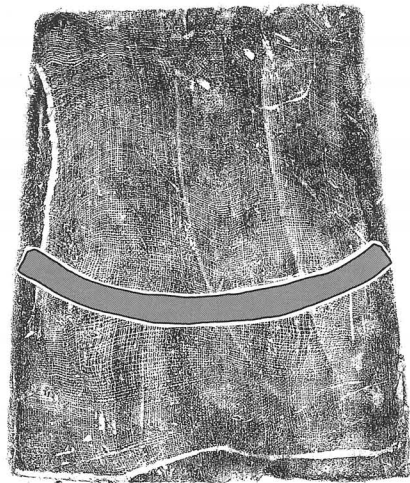
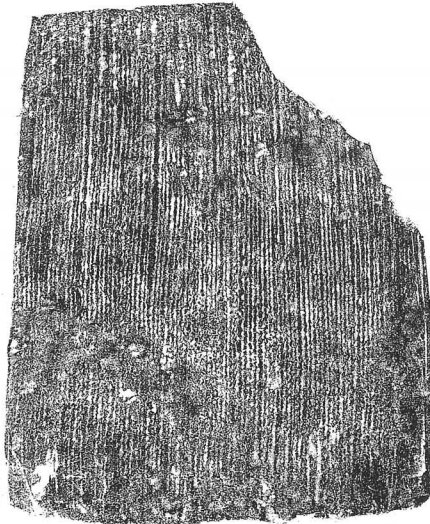
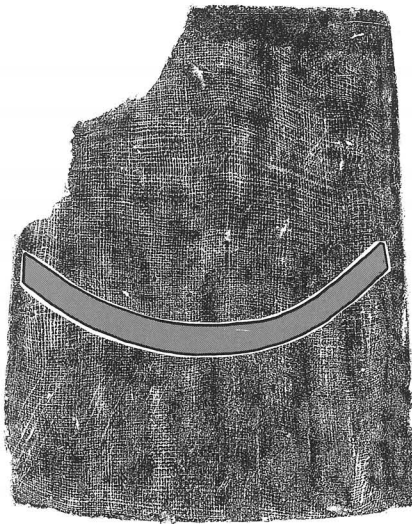

35

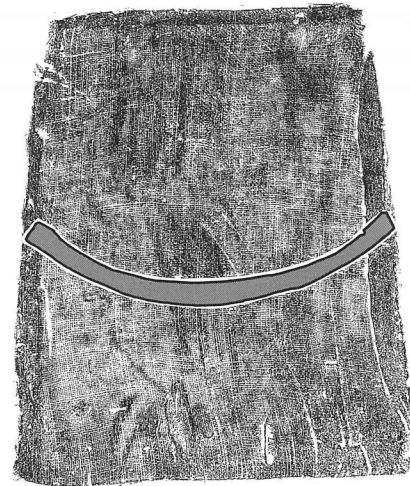
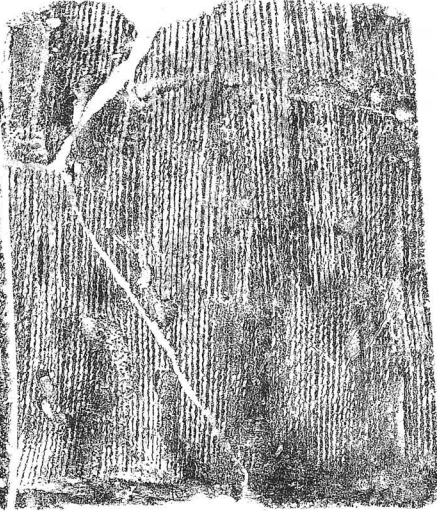
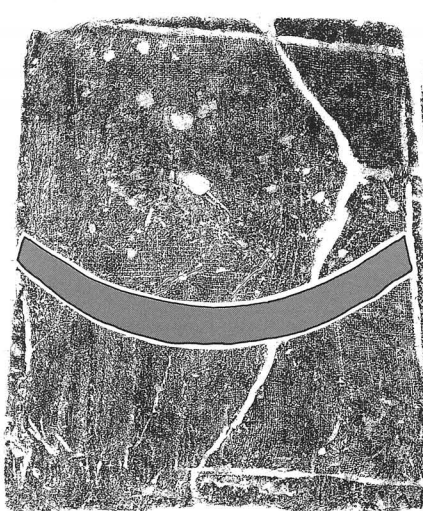

36(h)

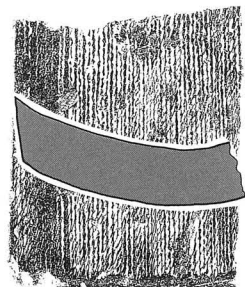
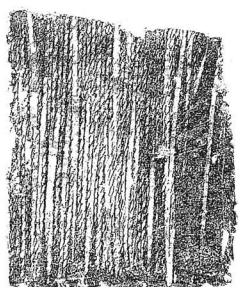

55

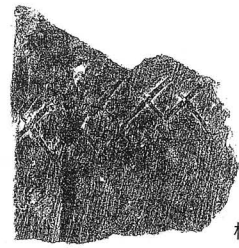
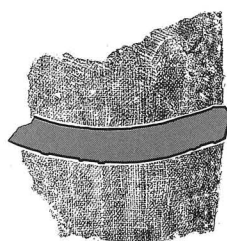

格子1

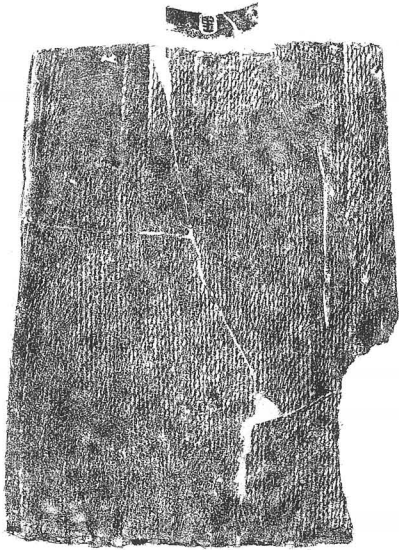

40

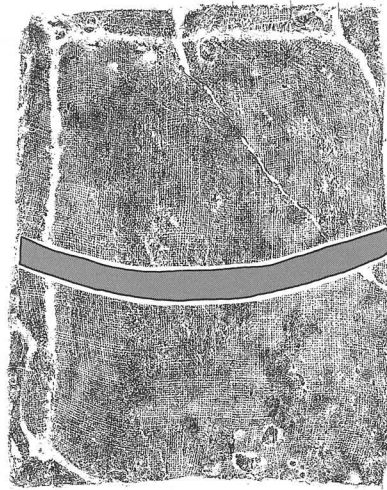

50(K)

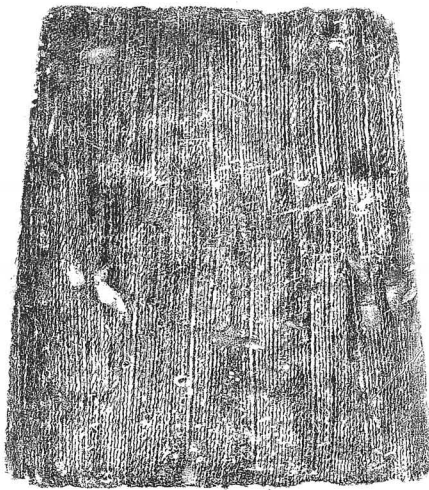

43(j1)

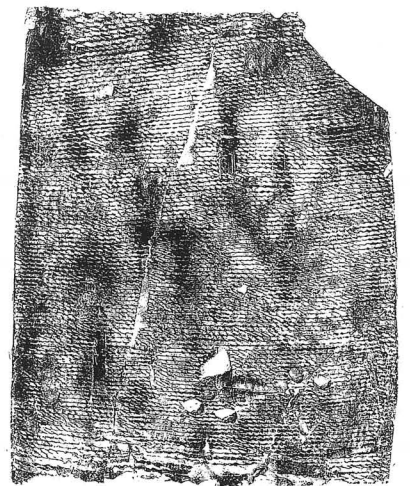
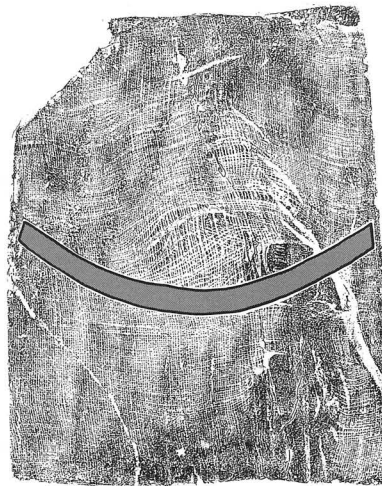

53(l)

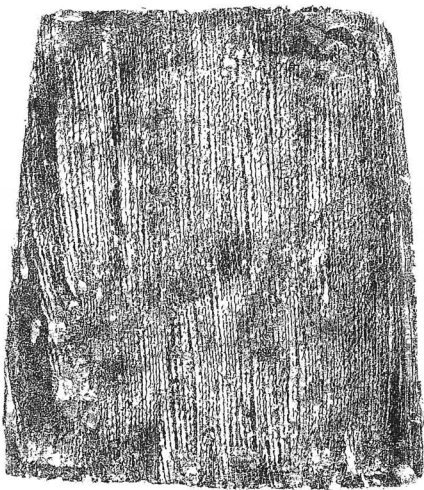

48(j2)

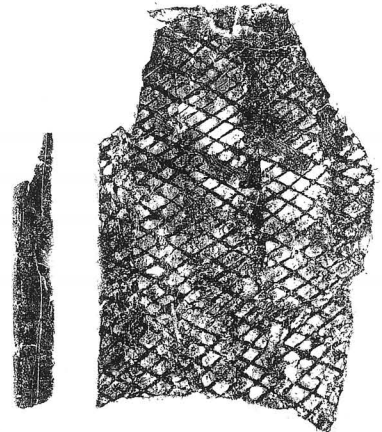
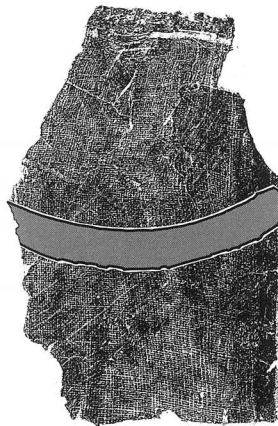

格子3

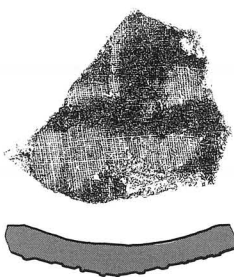

格子2

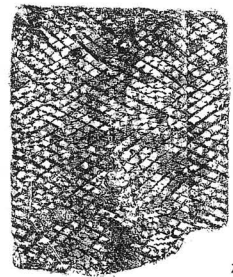
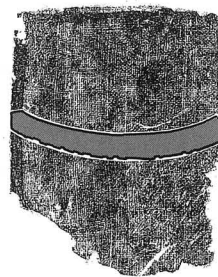

格子4



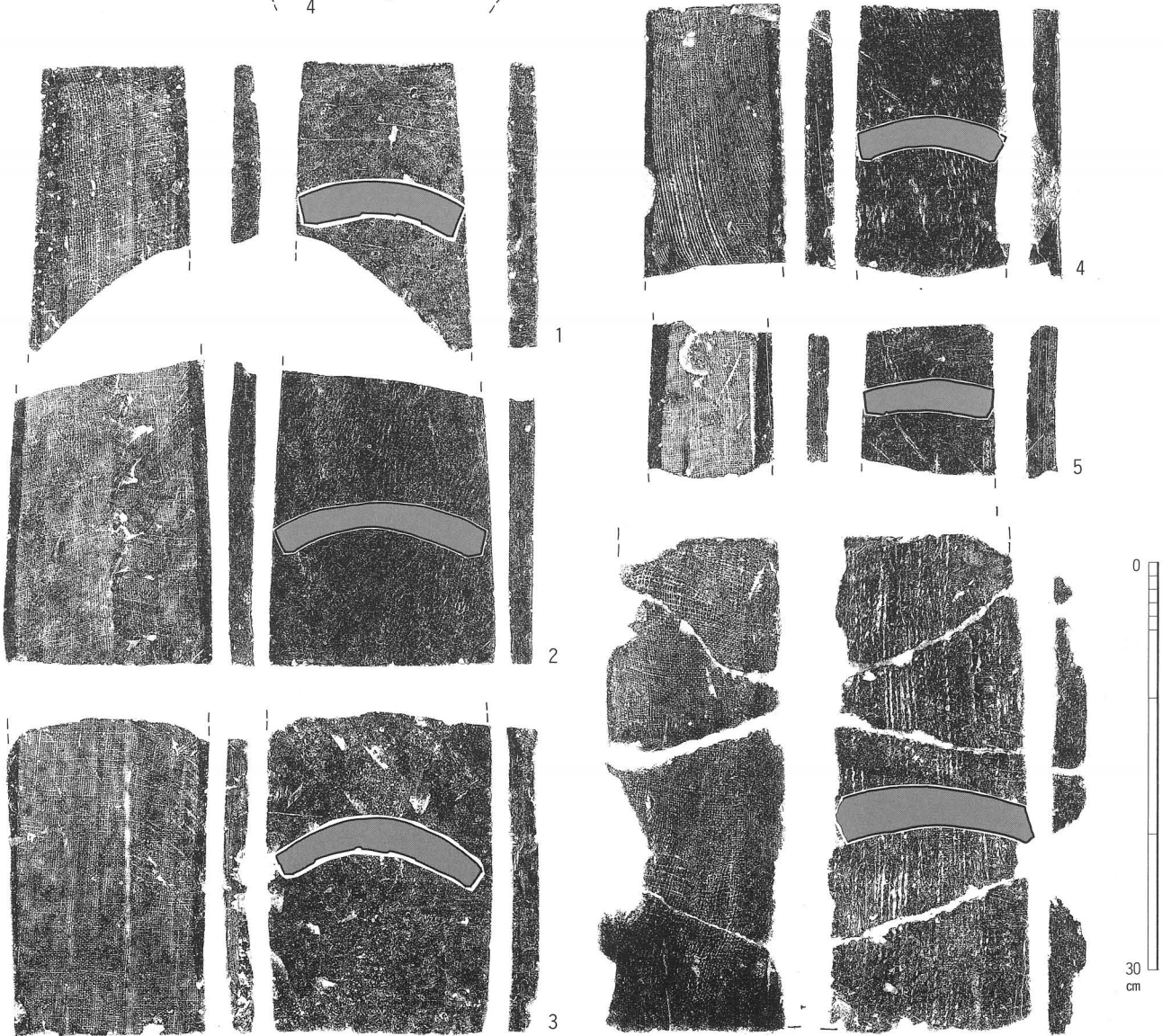
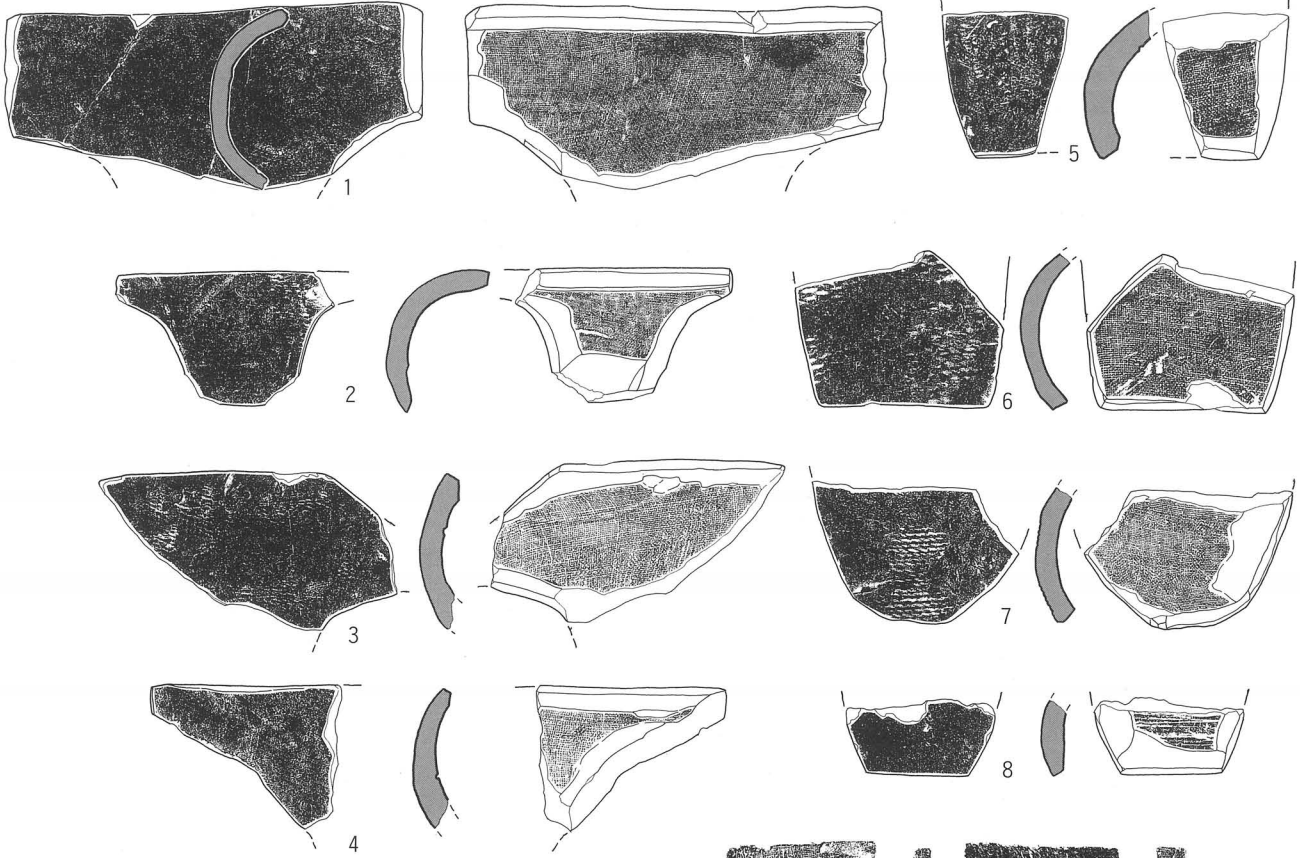

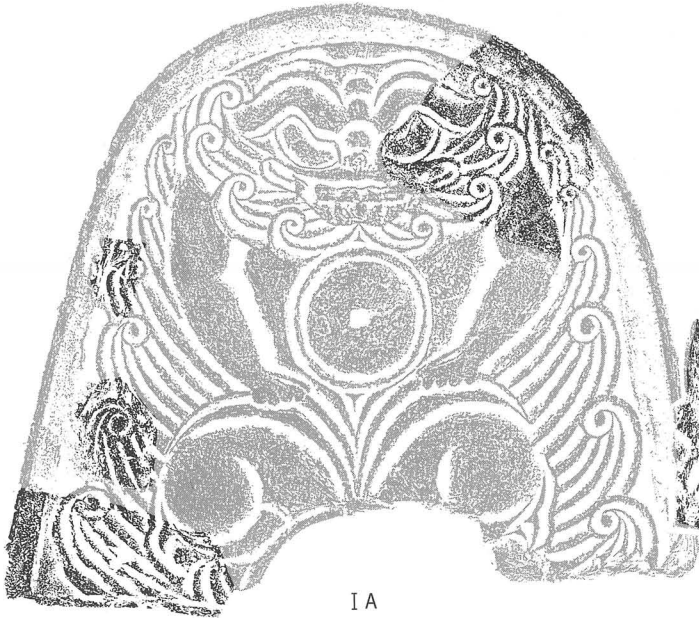

IA

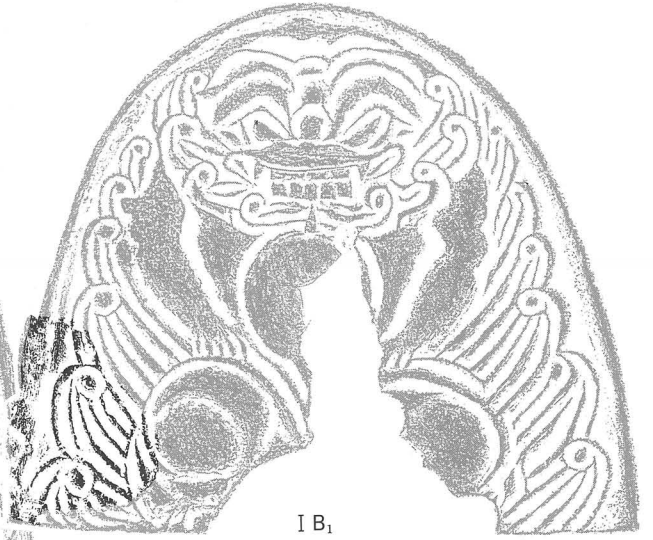

IB₁



II A₁

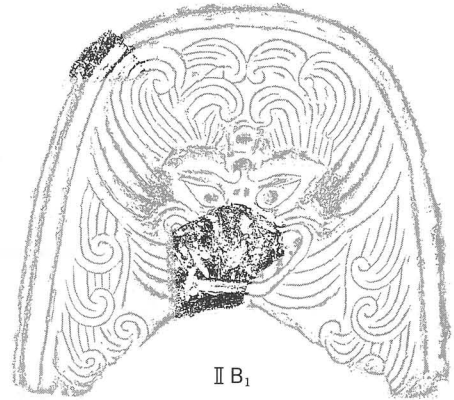

II B₁



III

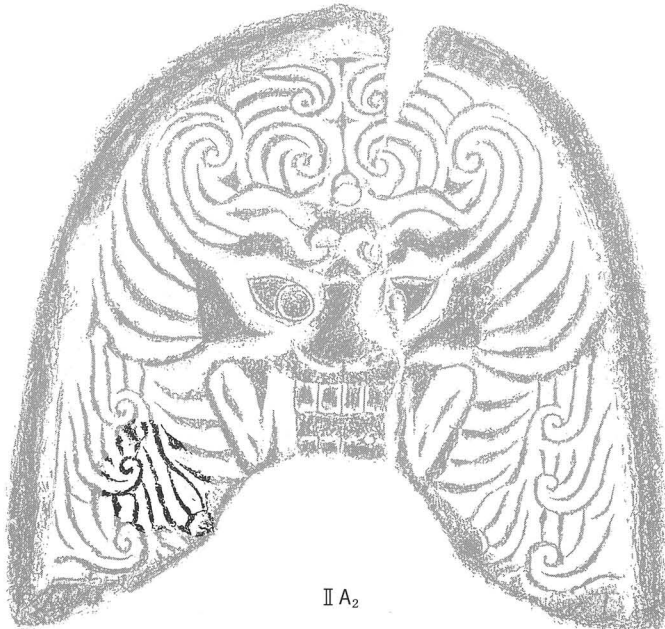

II A₂

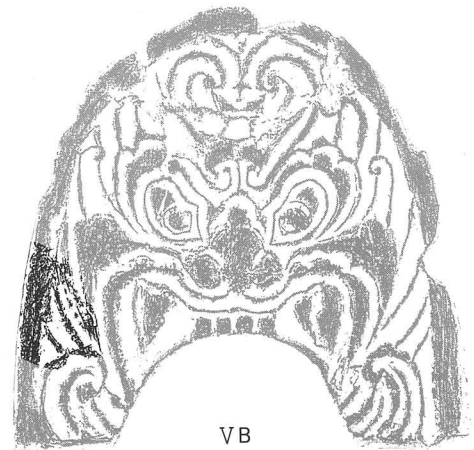

VB



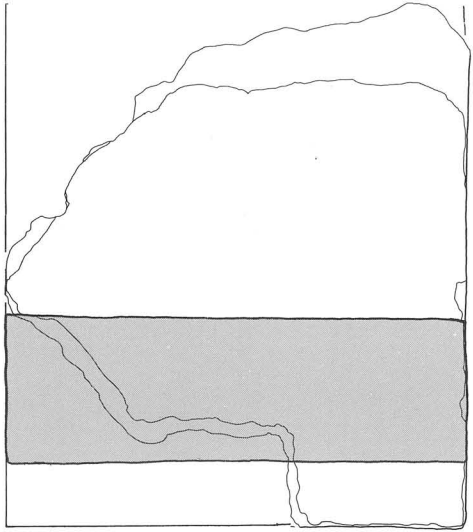

I

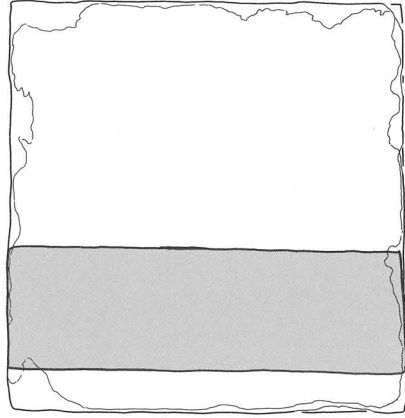

II

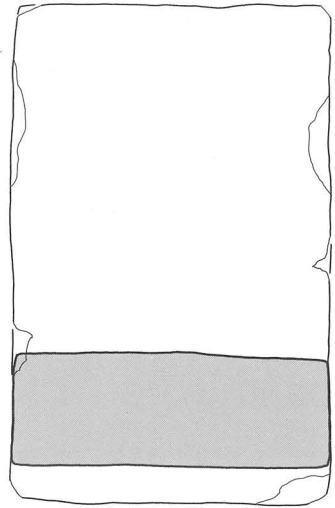

III

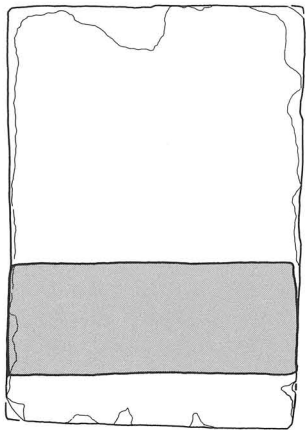

IV

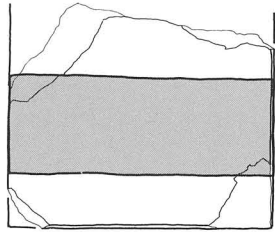

Va

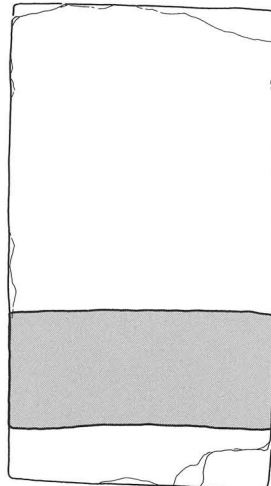

Vb

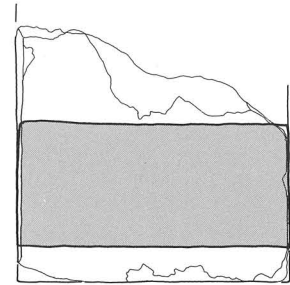

Vc

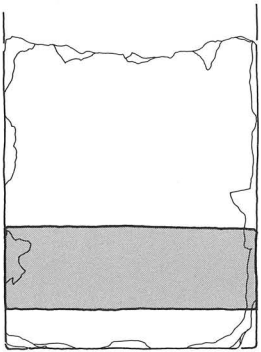

VIa

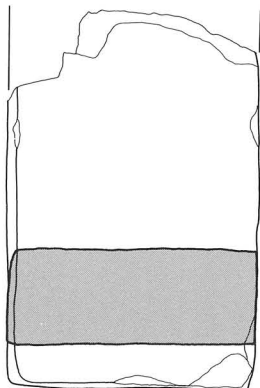

VIb

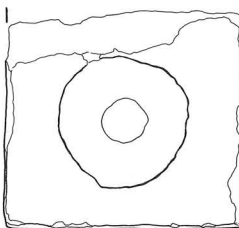
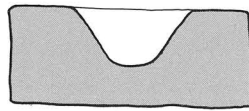

1

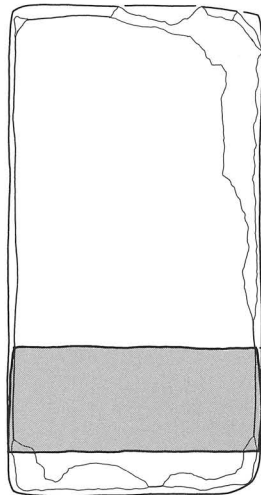

VIc

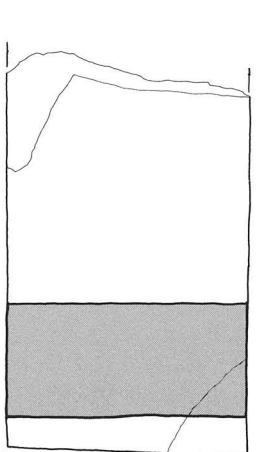
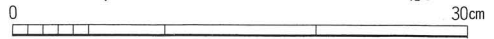

VIIa

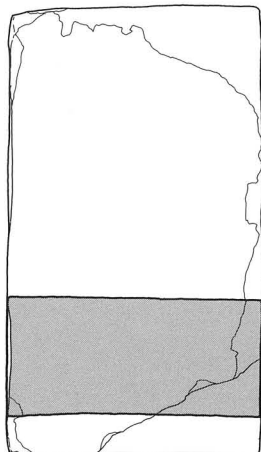

VIIb

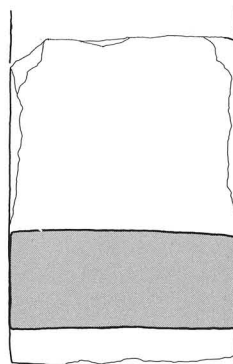

VIIc

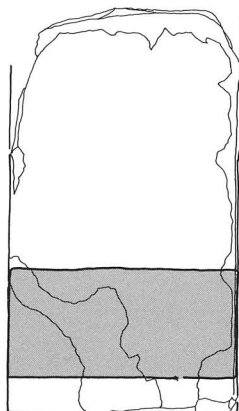

VIIe

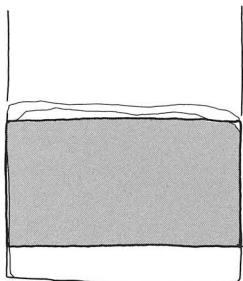

VIIe

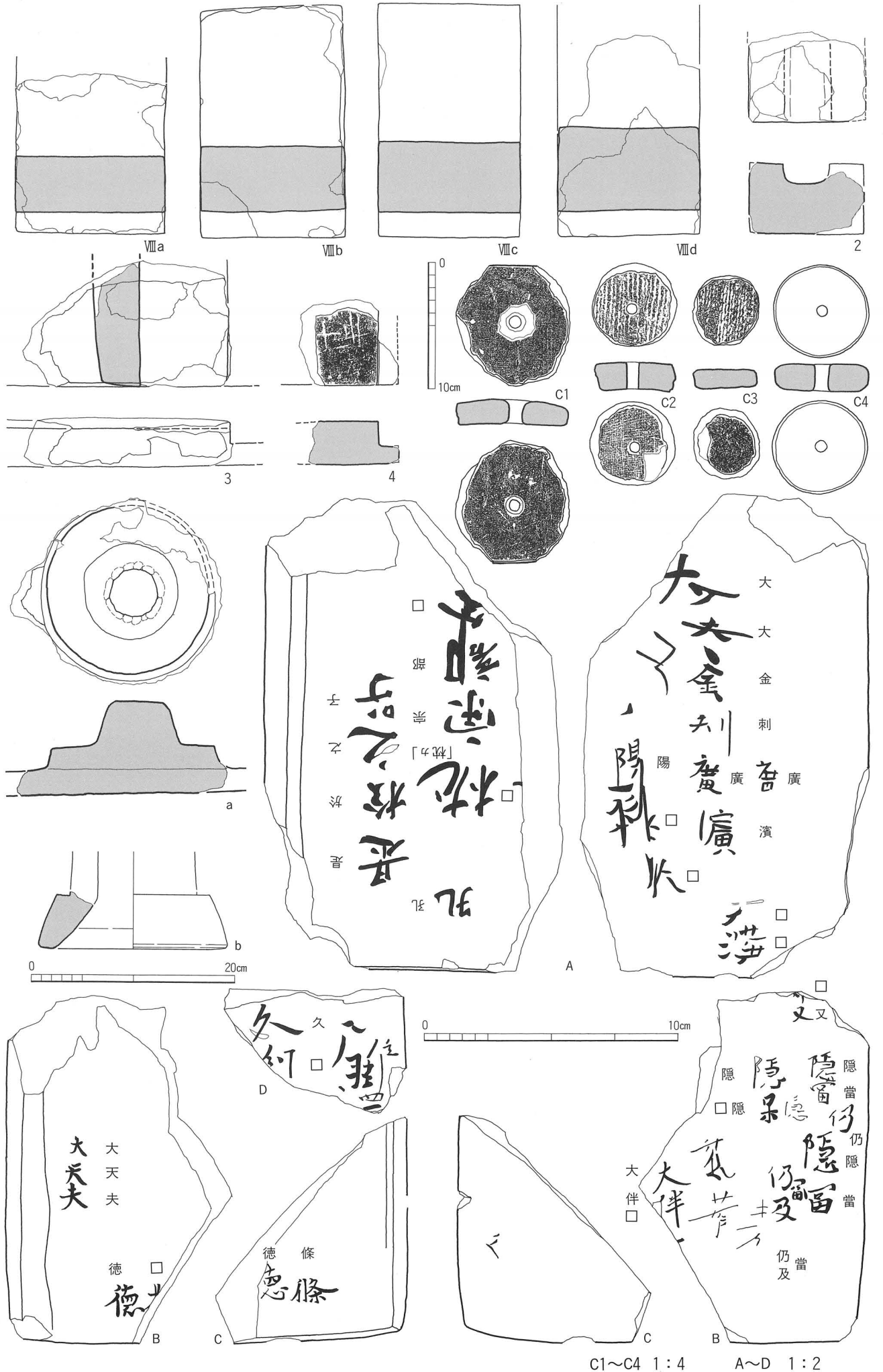

C1~C4 1:4

A~D 1:2

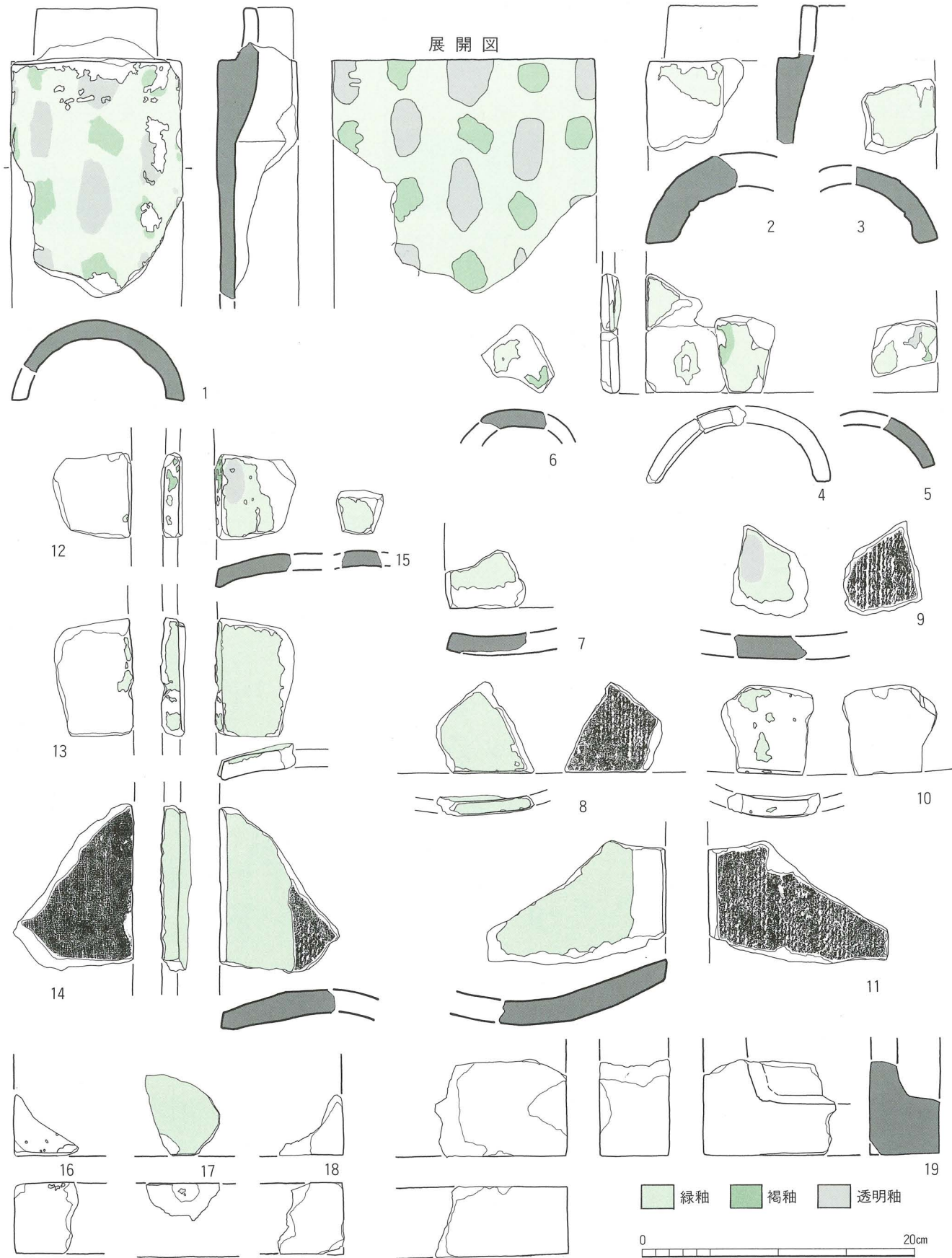

1~6 丸瓦 7~11 平瓦 12~15 鬩斗瓦 16~19 塼
1:4

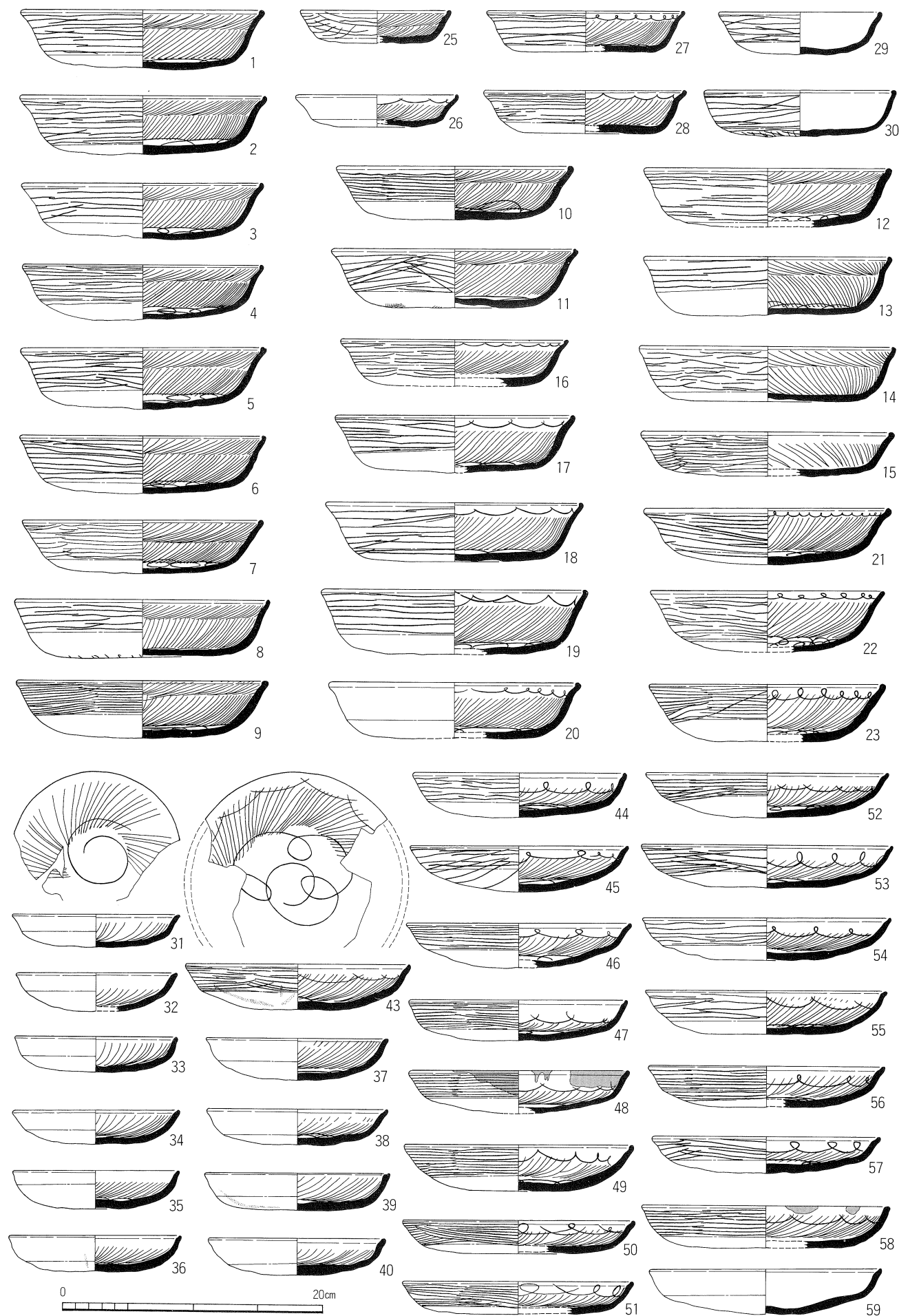

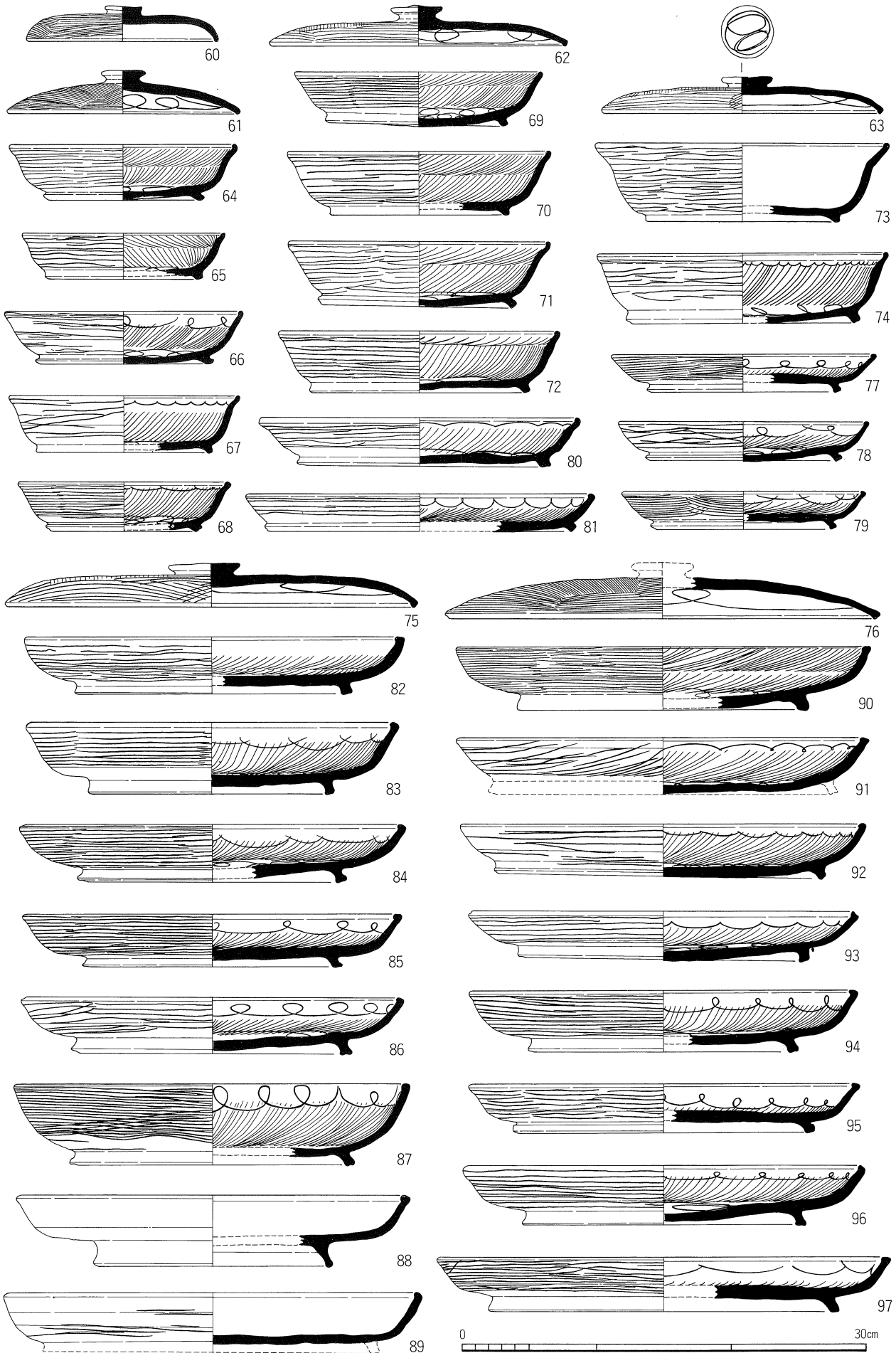

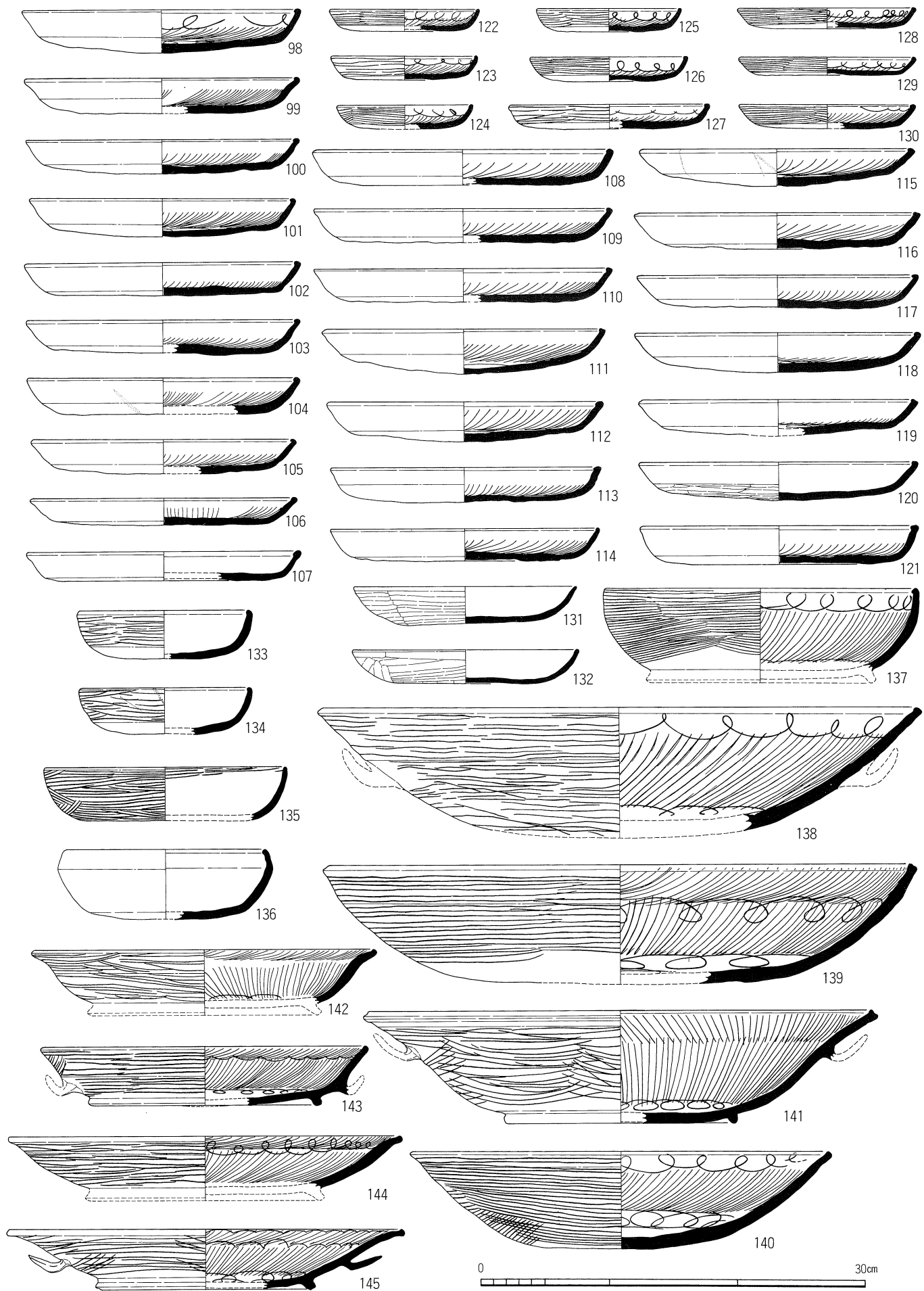

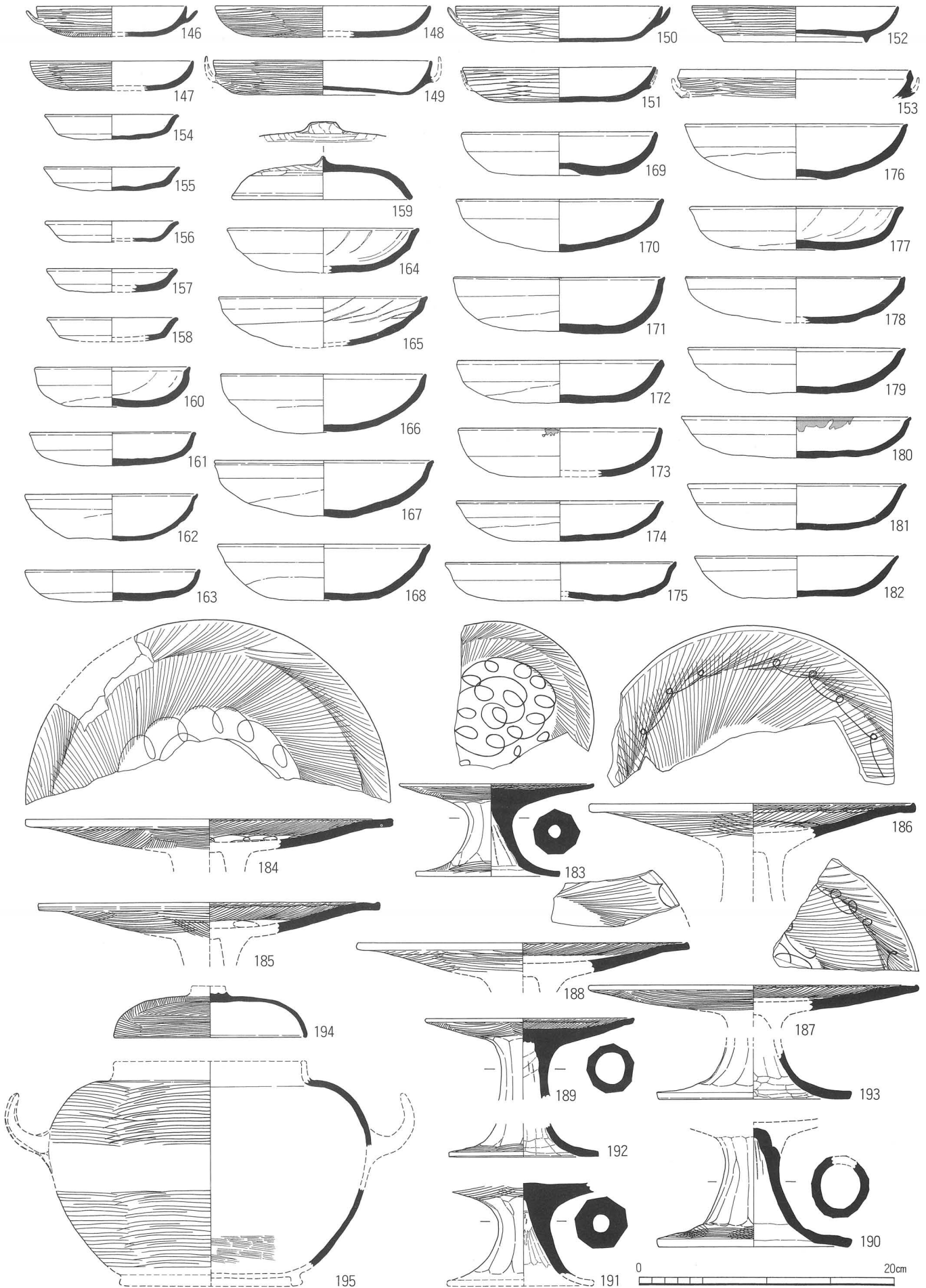

173・180は煤付着 1 : 4

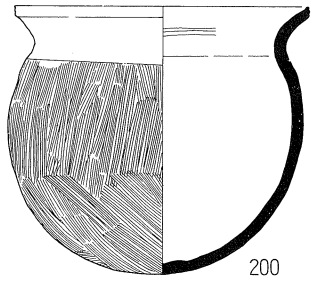

200

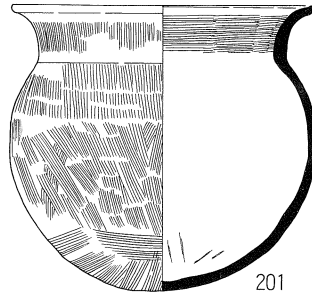

201

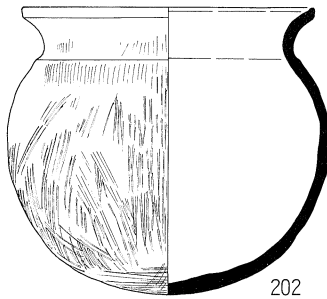

202

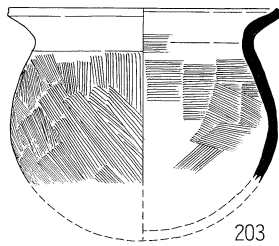

203

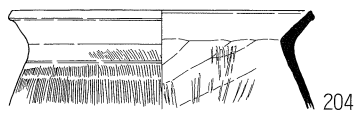

204

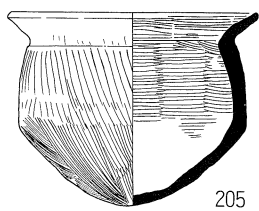

205

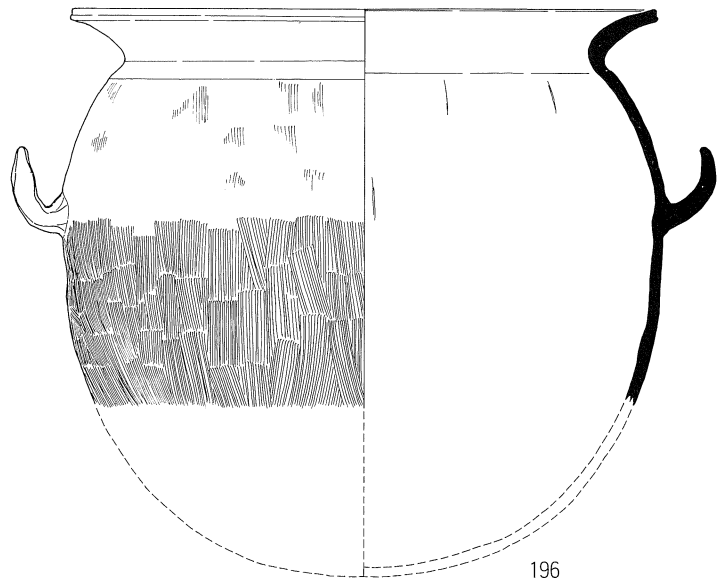

196

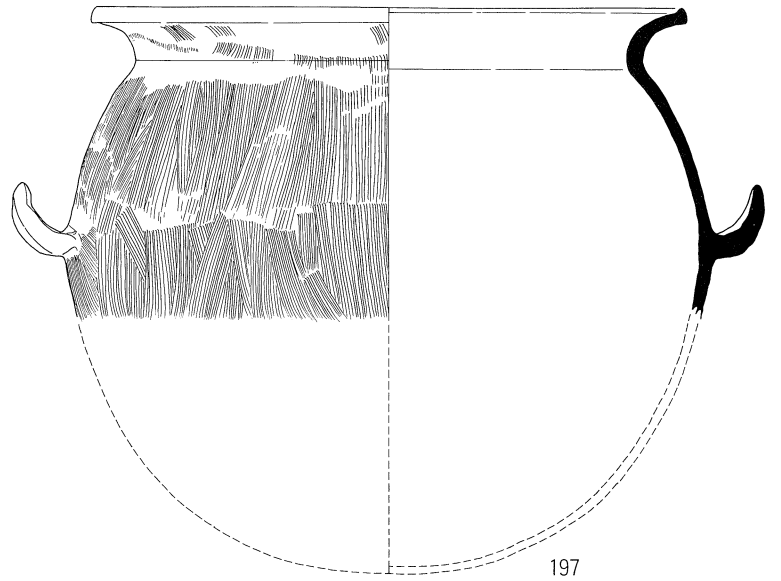

197

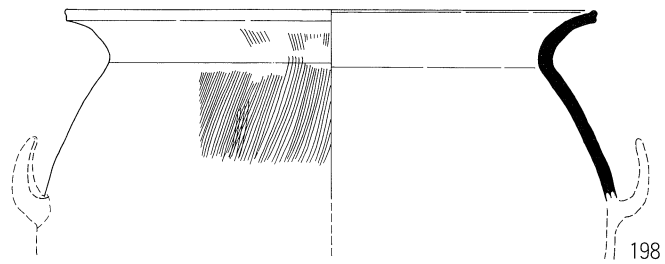

198

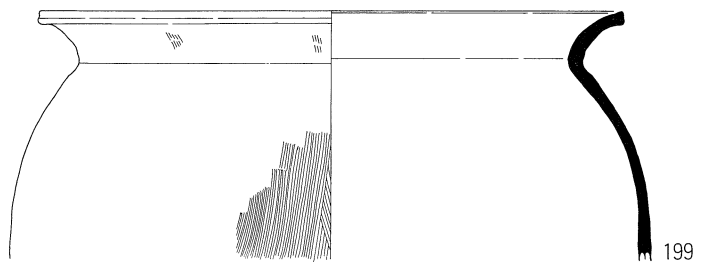

199

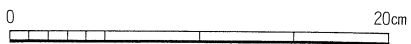

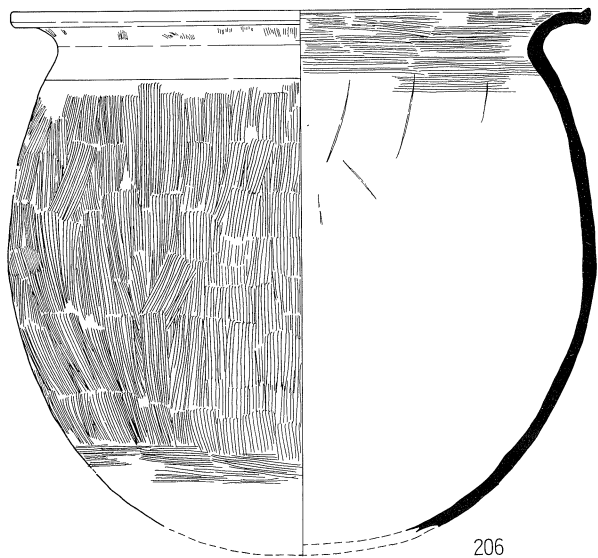

206

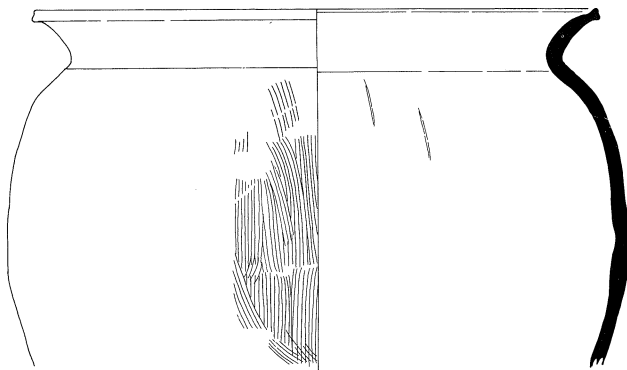

209

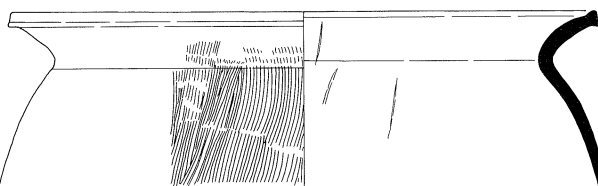

207

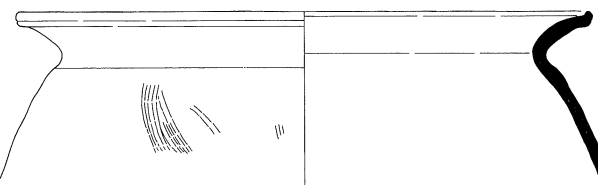

208

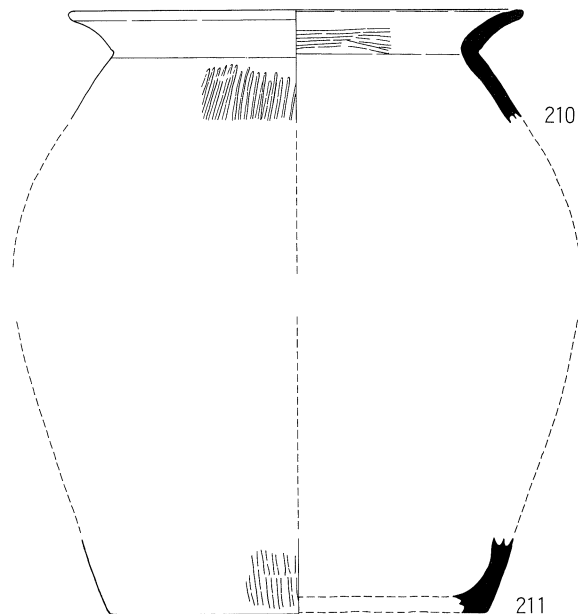

210

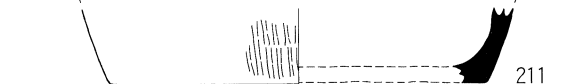

211

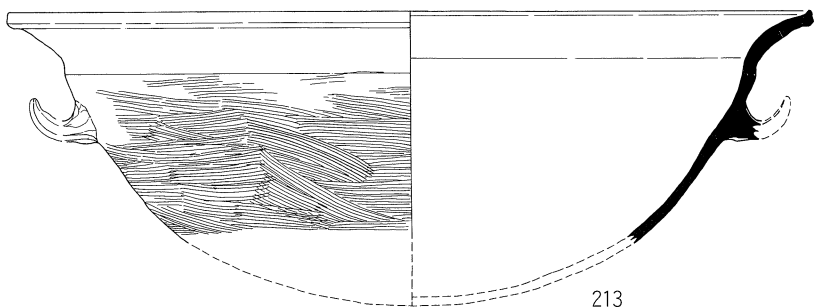

213

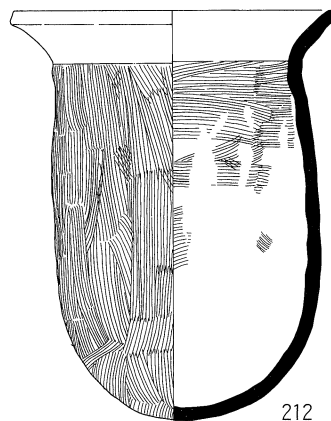

212

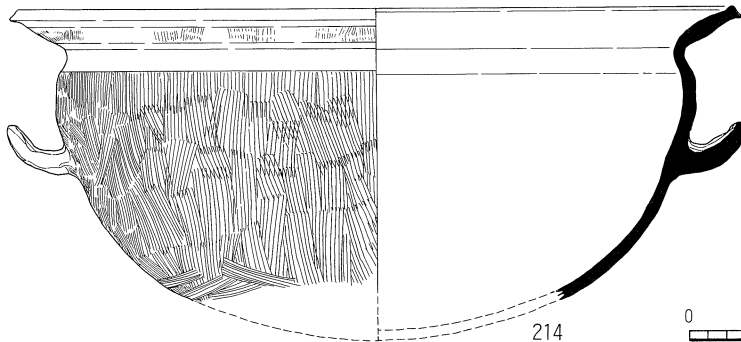

214

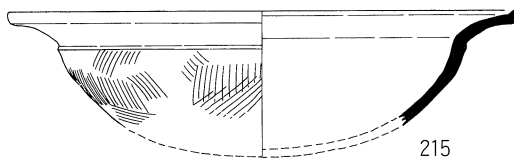

215

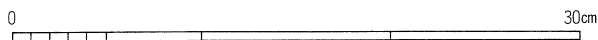

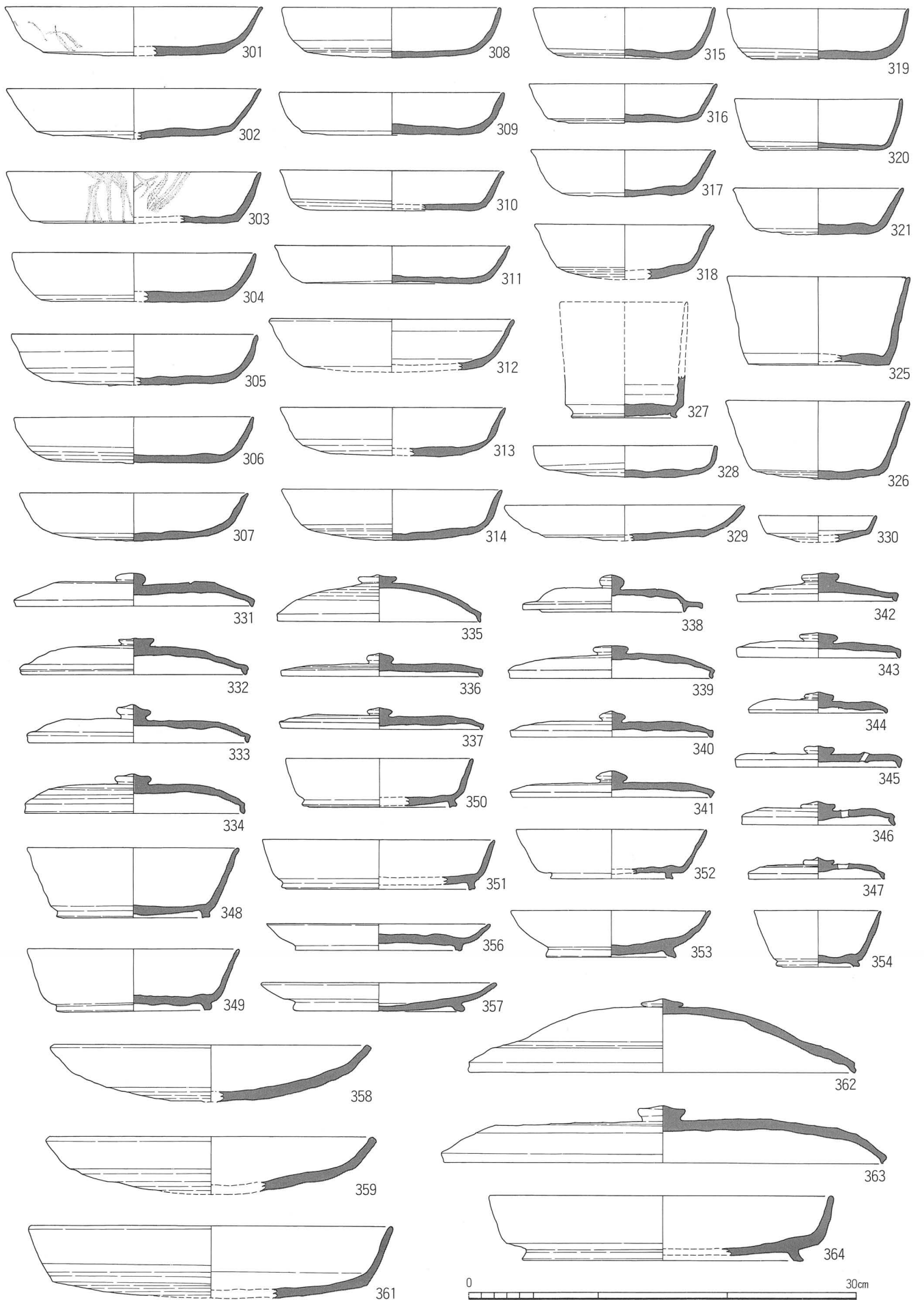

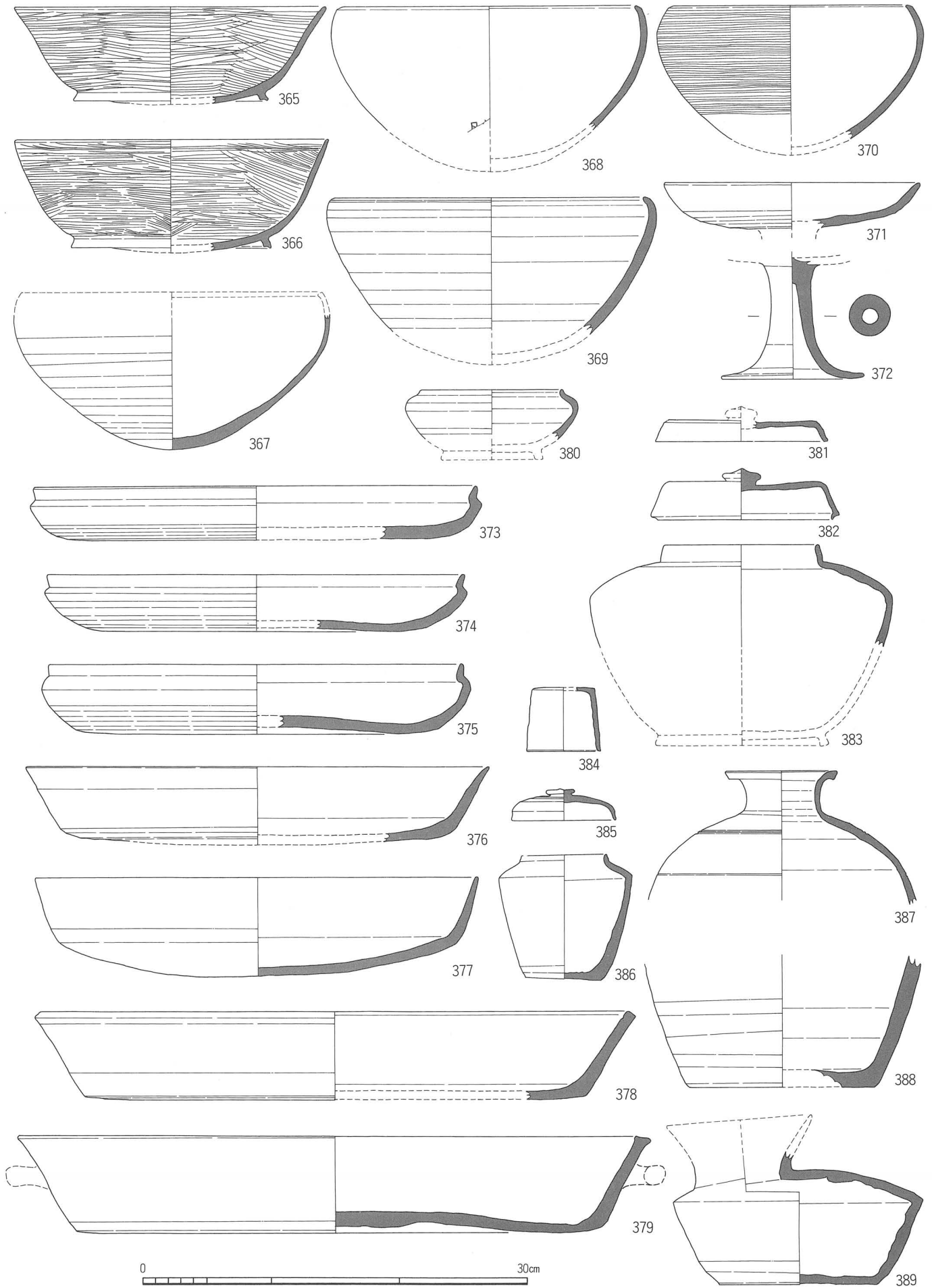

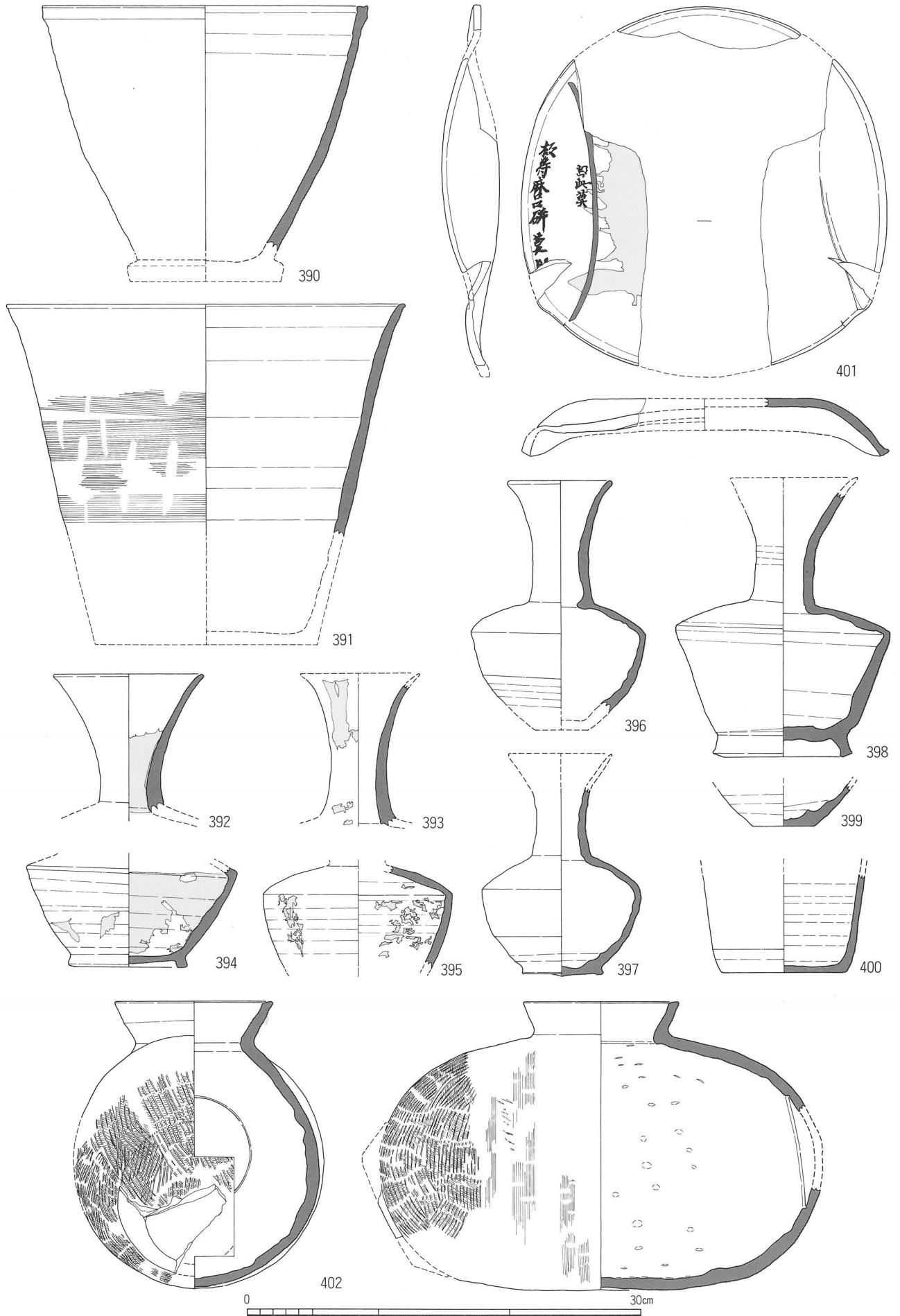

392~395は漆付着

401は墨線と墨痕

1 : 4

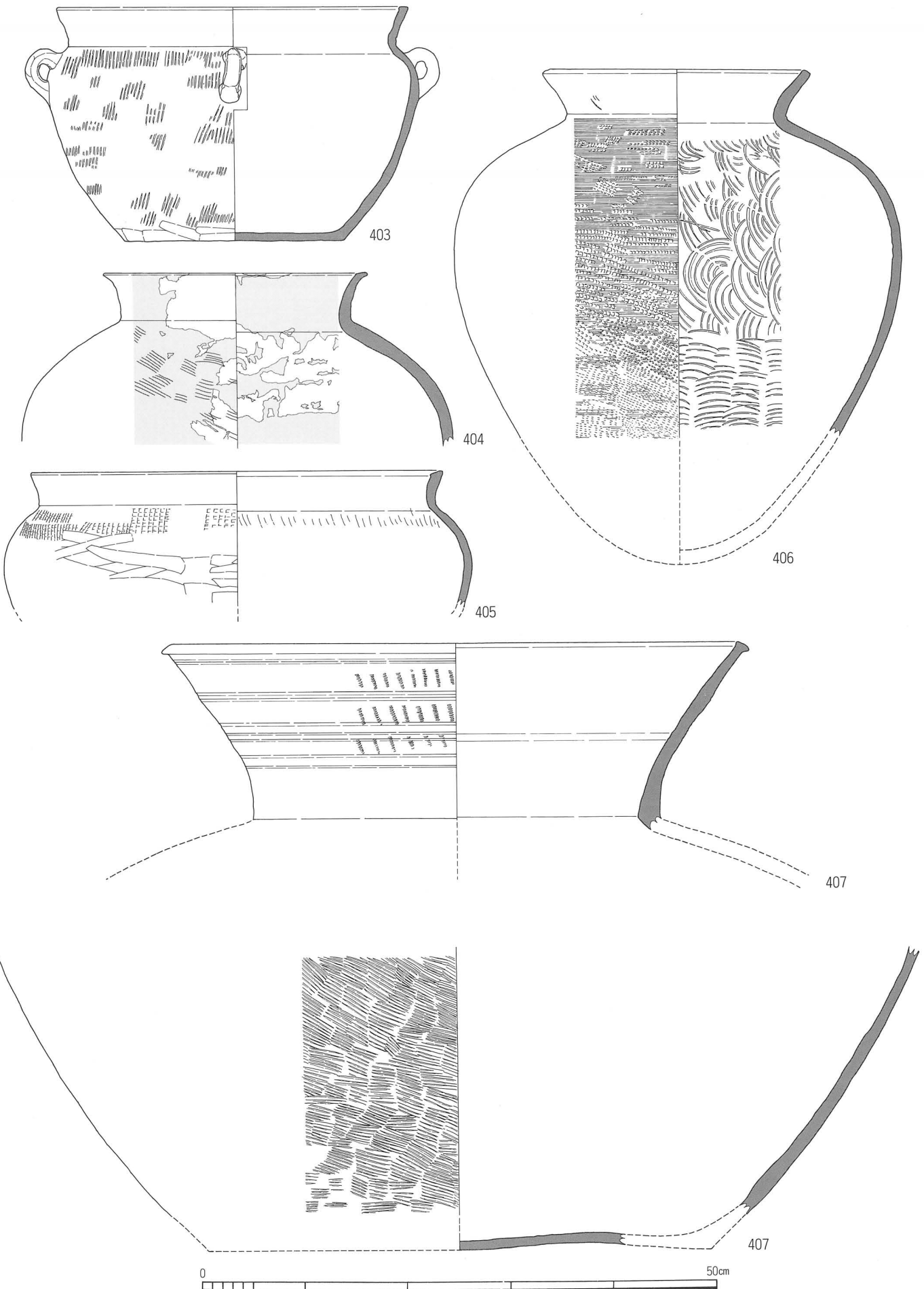

404は漆付着 1:5

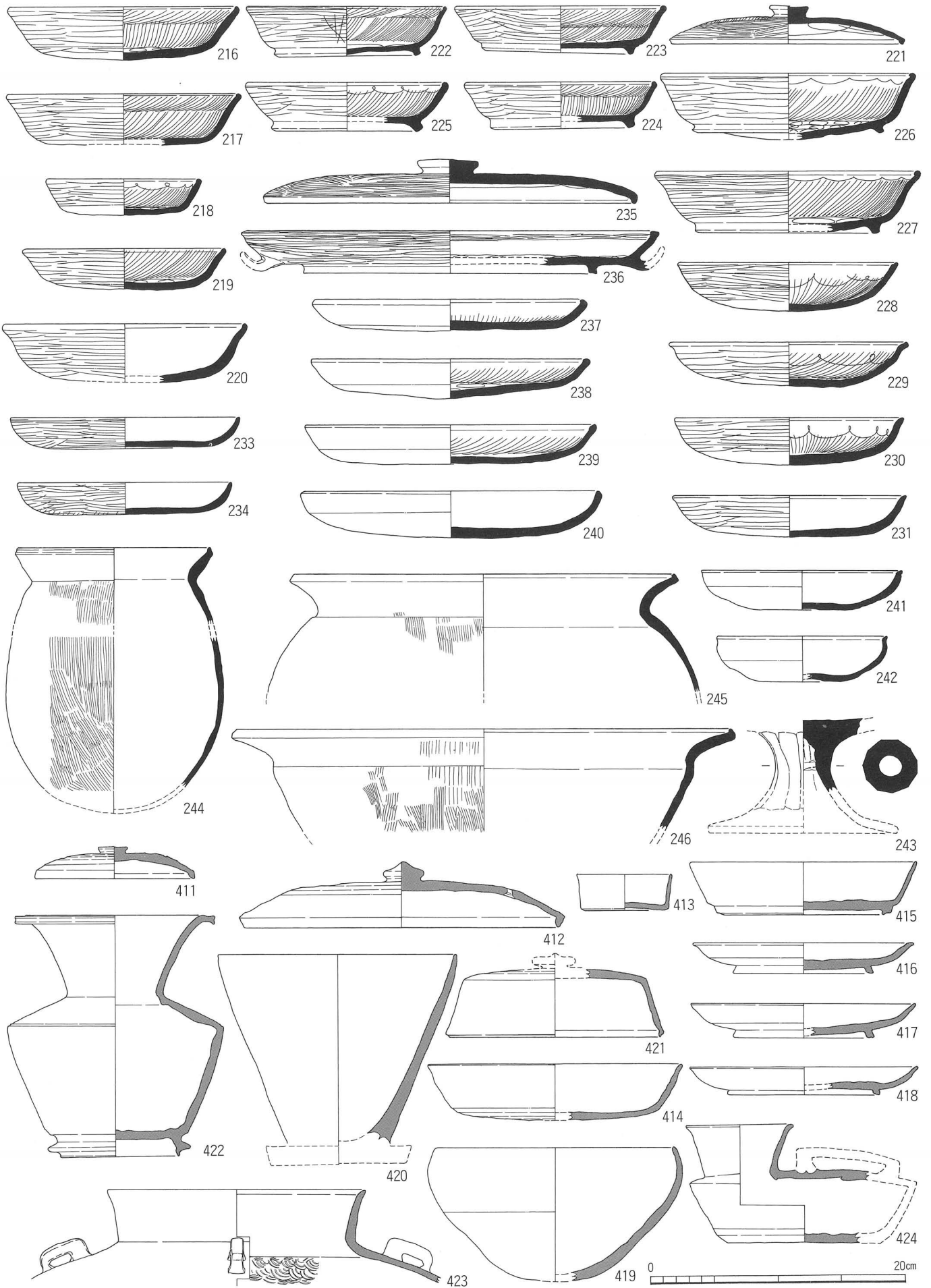

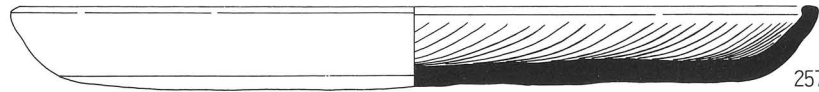

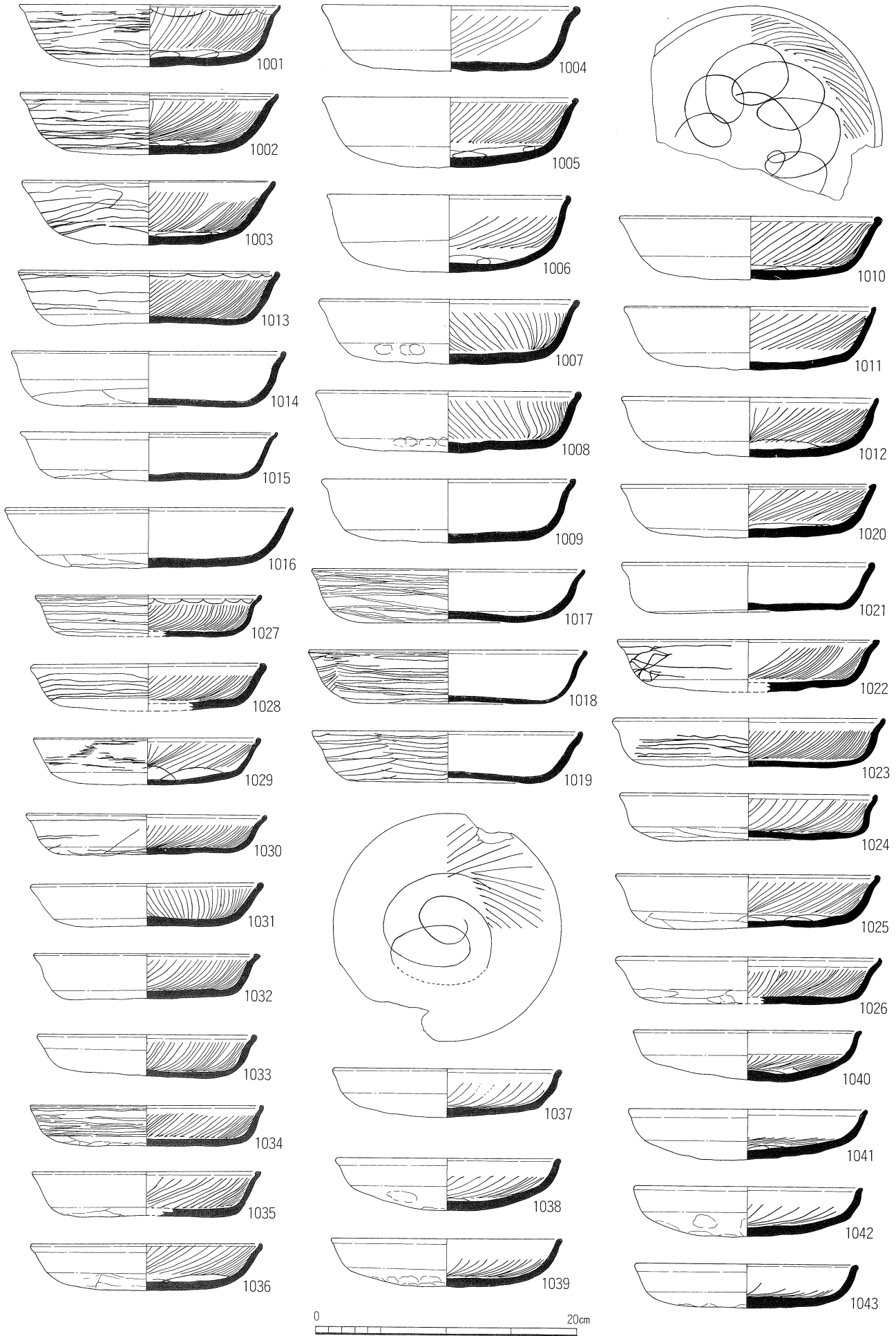

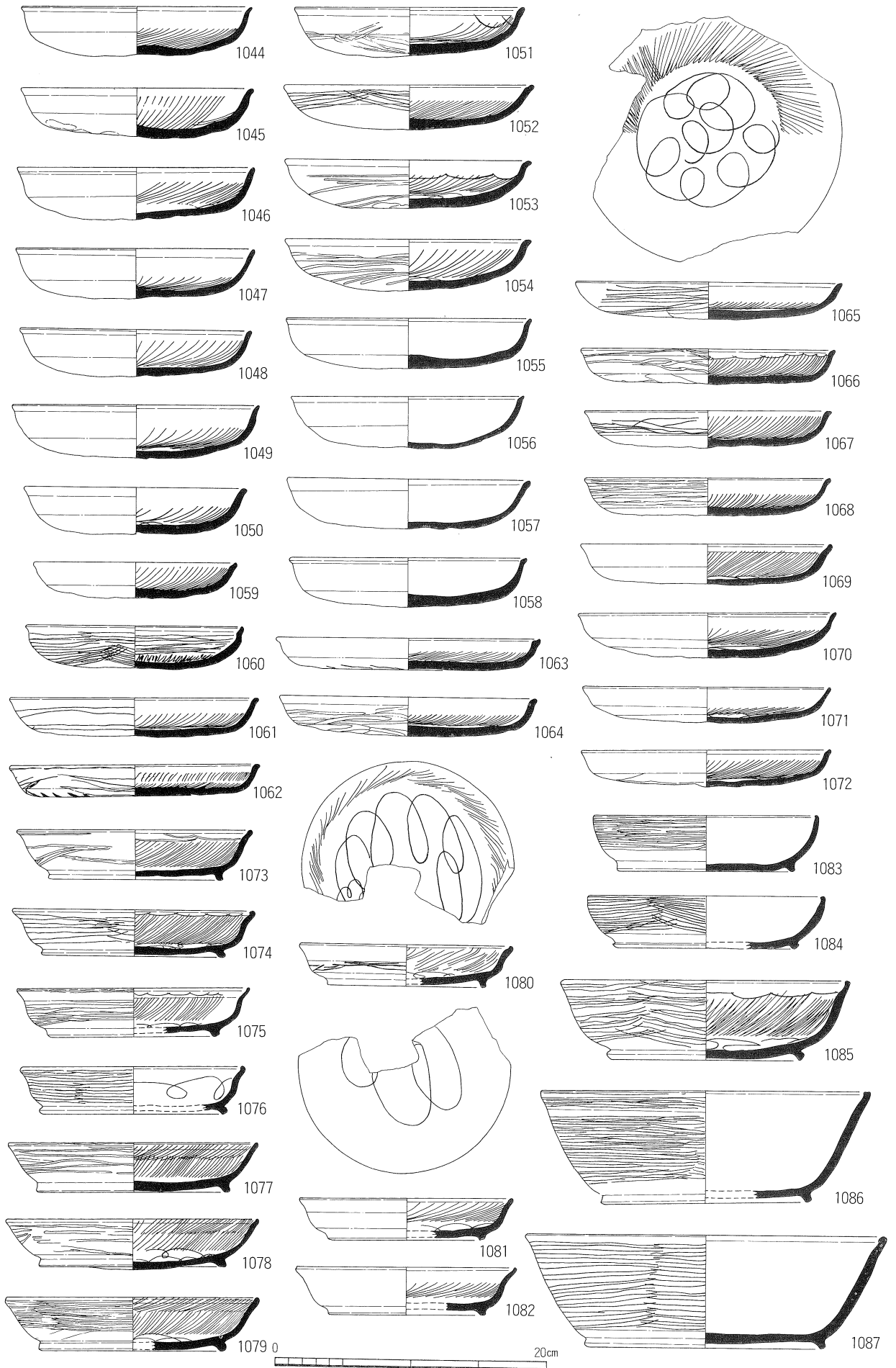

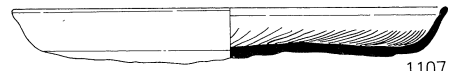
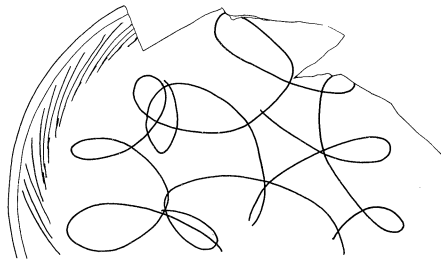
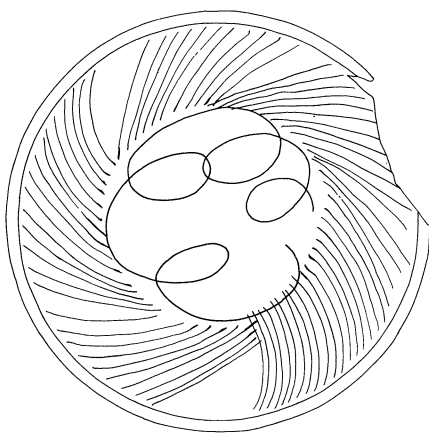

1107

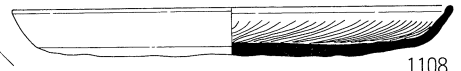

1108

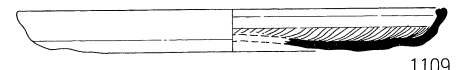

1109

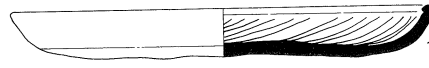

1088

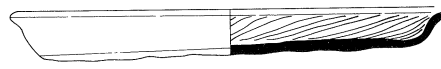

1100

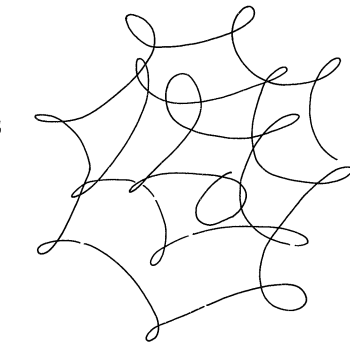
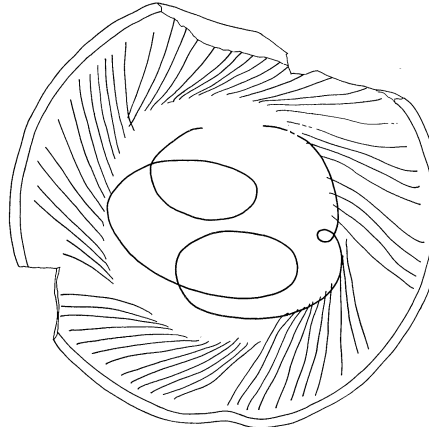
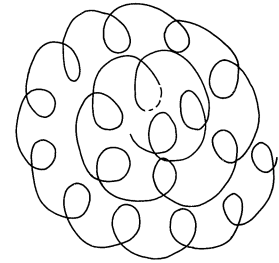

1110



1111



1112

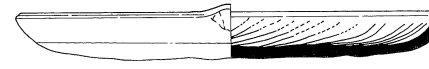

1089

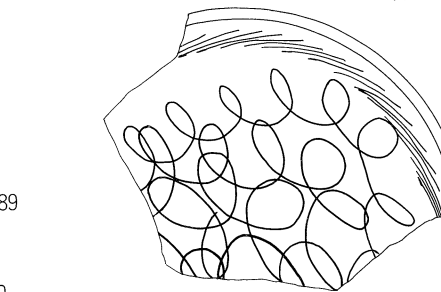

1090



1102

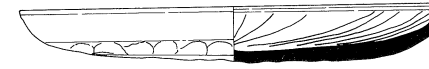

1091

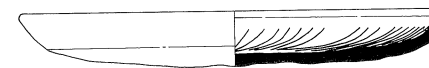

1092



1093

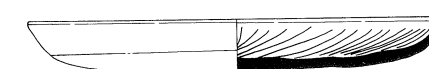

1094



1095

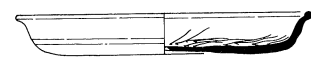
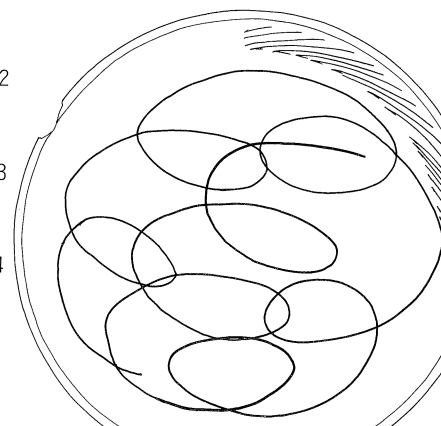

1113



1096



1114

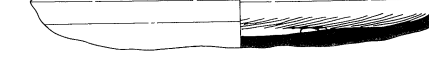

1097



1115



1098

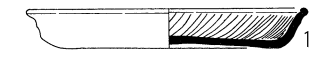

1116



1099

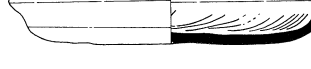

1117



1103

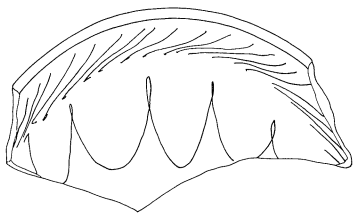

1104



1105



1106



1118

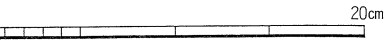

20cm

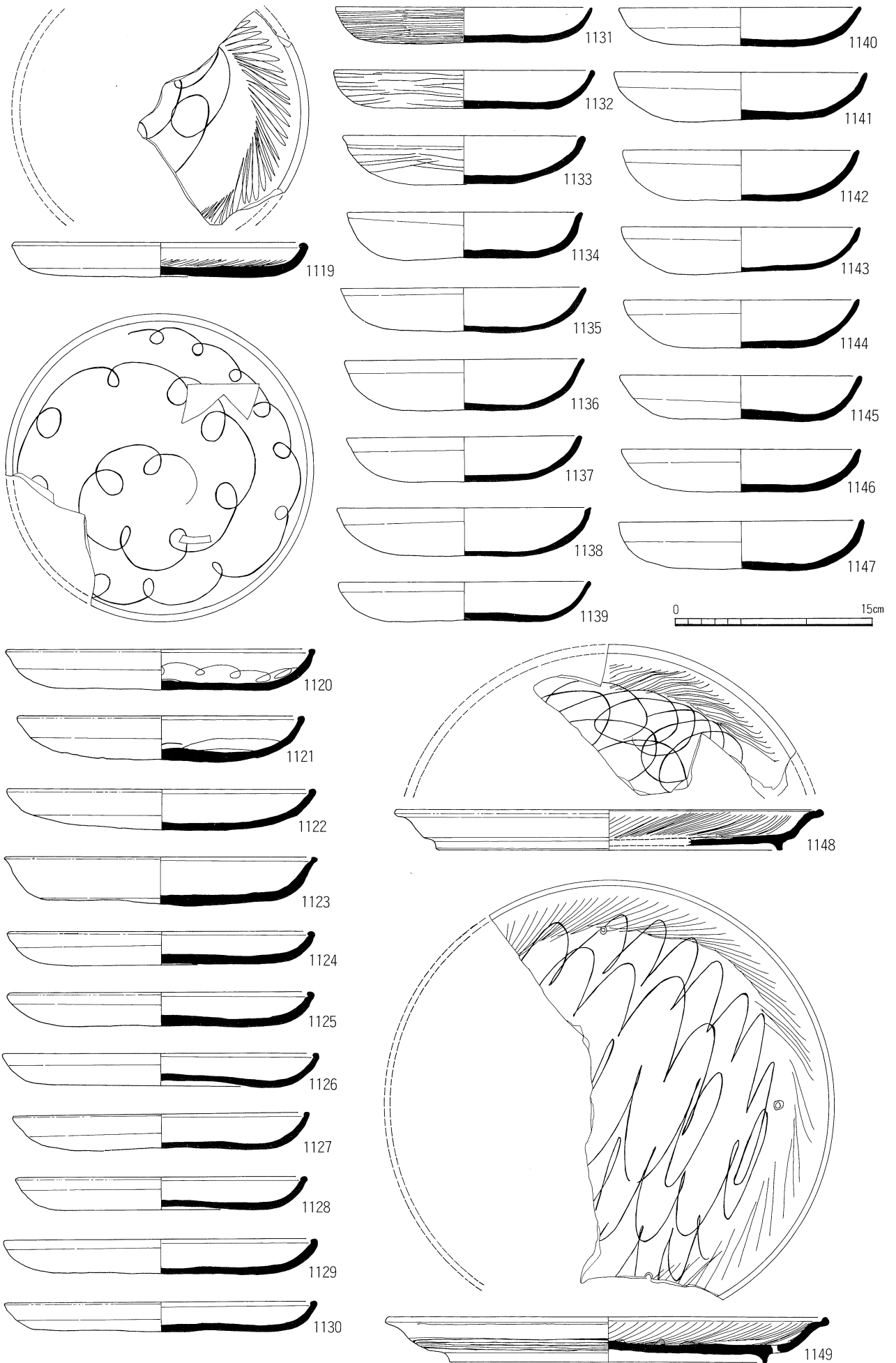

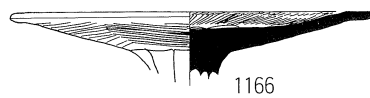
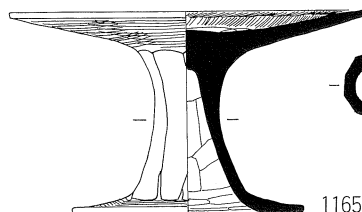
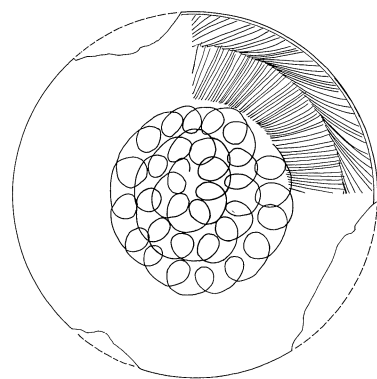
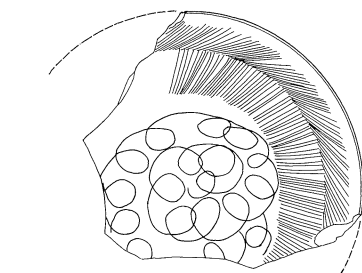
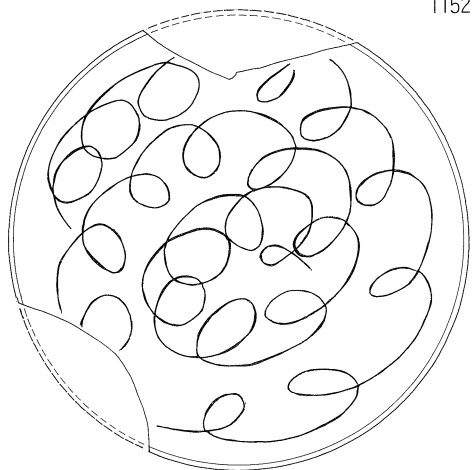
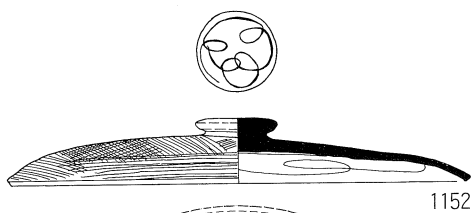
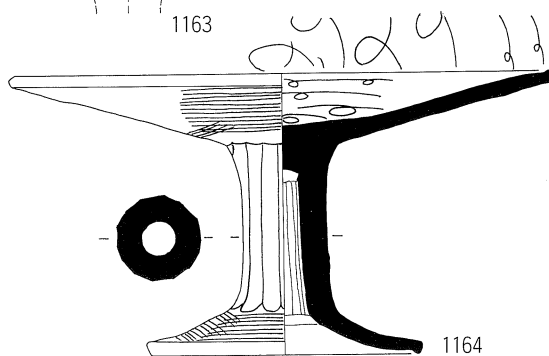
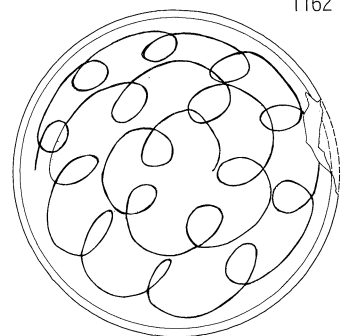
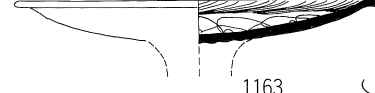
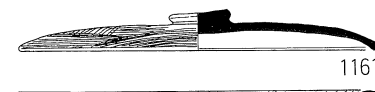
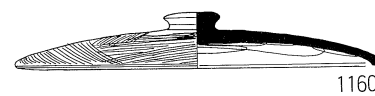
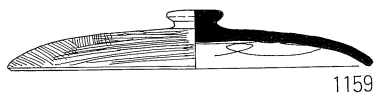
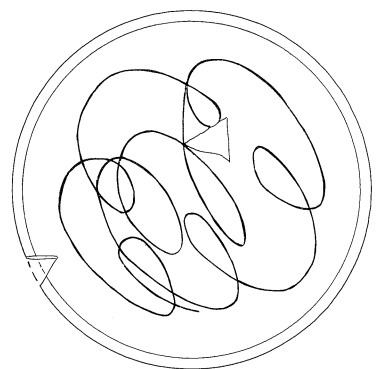
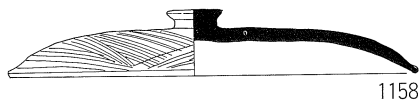
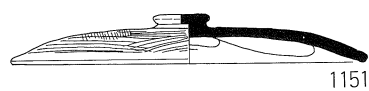
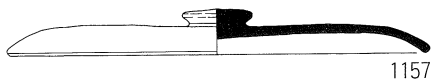
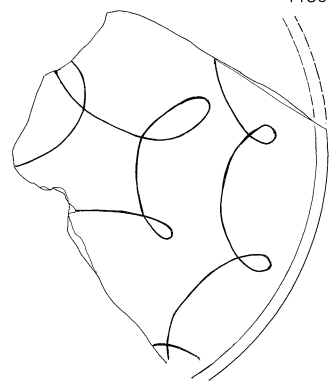
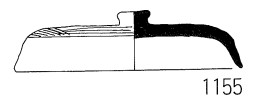
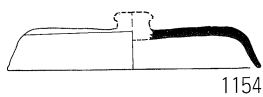
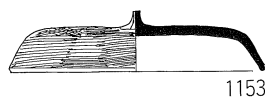
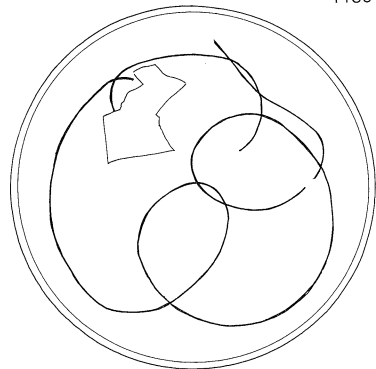
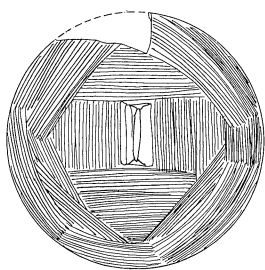
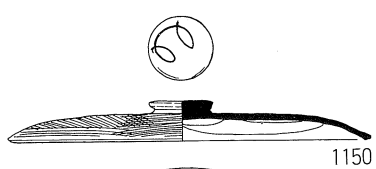

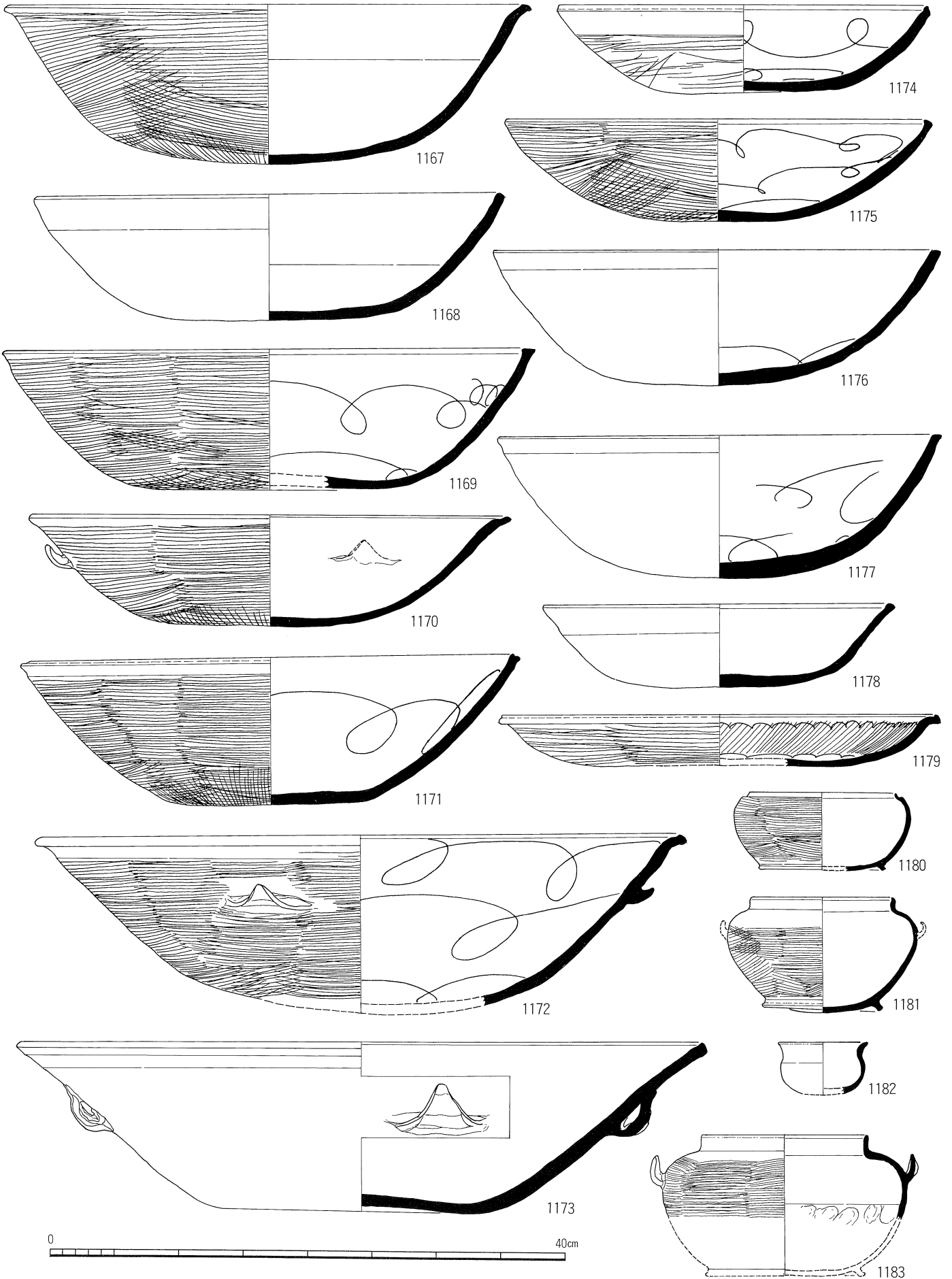

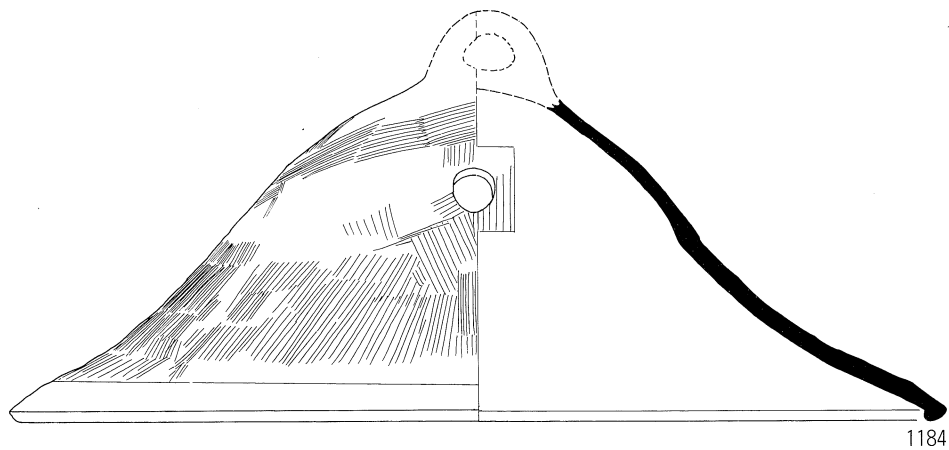

1184

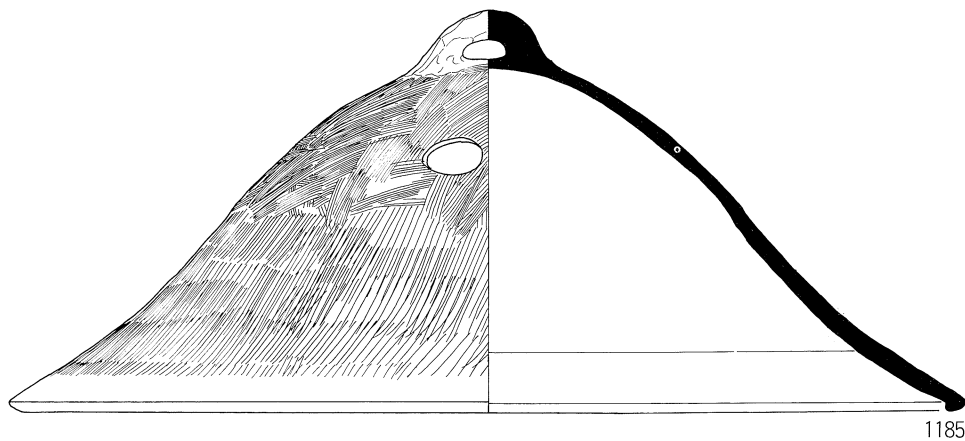

1185

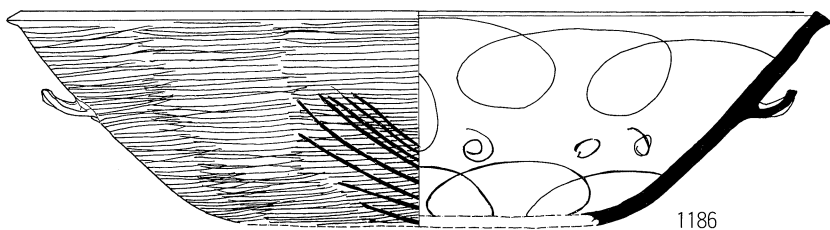

1186

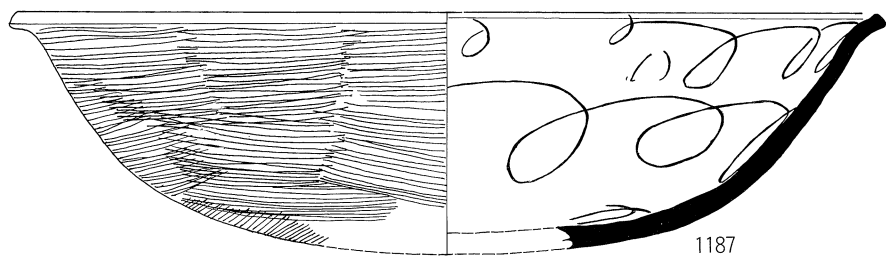

1187

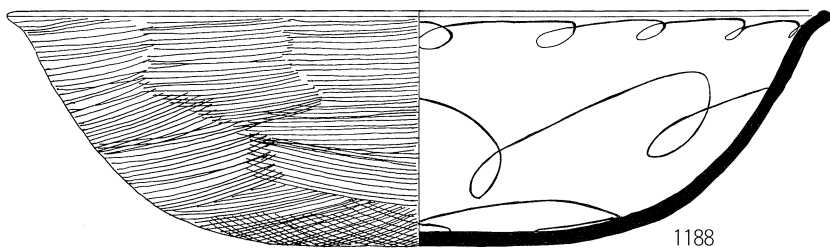

1188

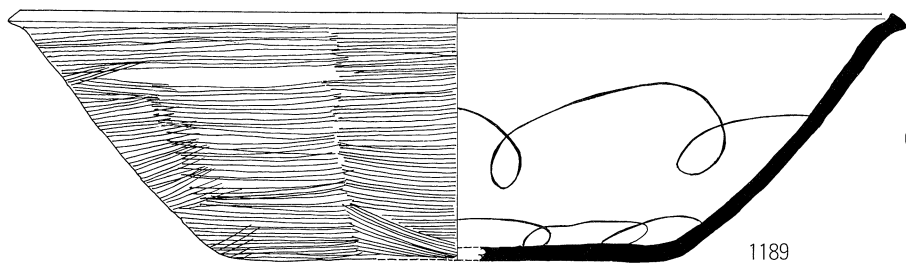

1189

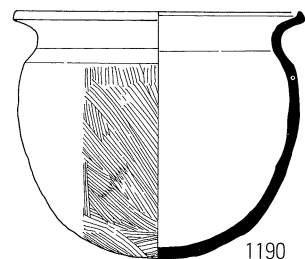

1190

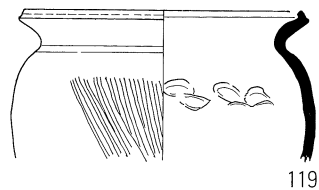

1191

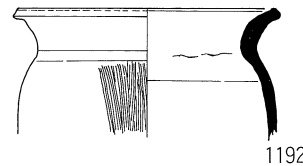

1192

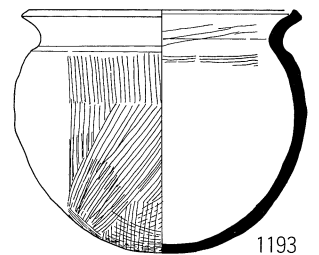

1193

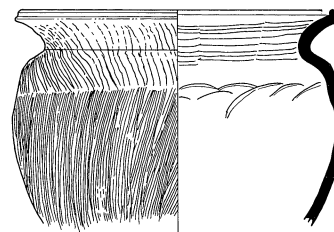

1194

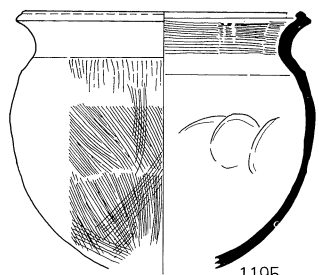

1195

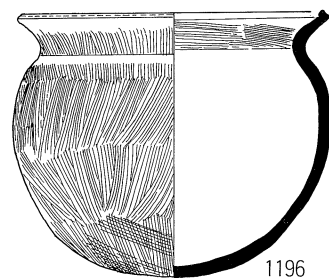

1196

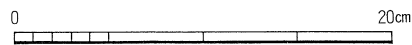

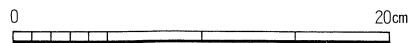
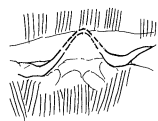
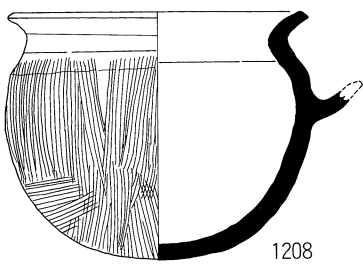
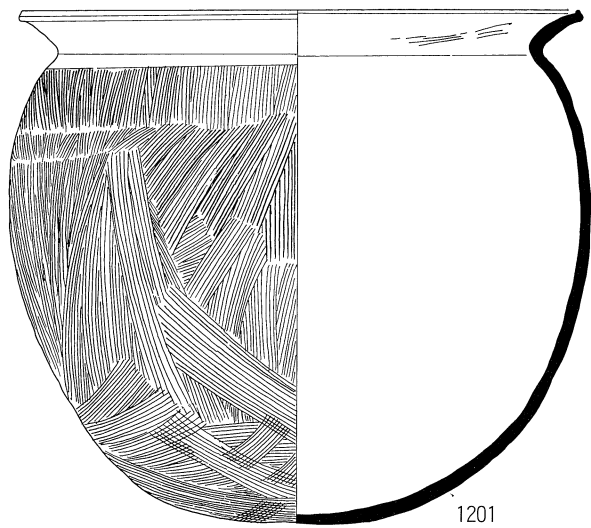
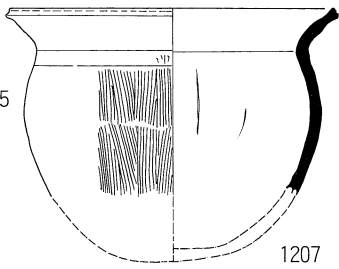
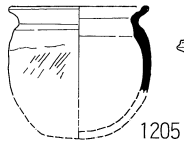
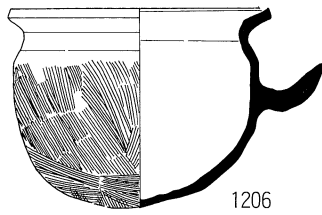
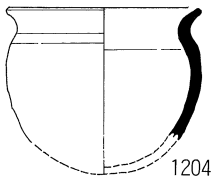
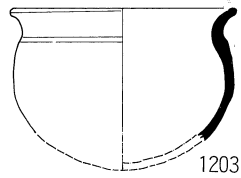
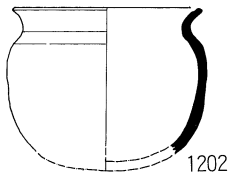
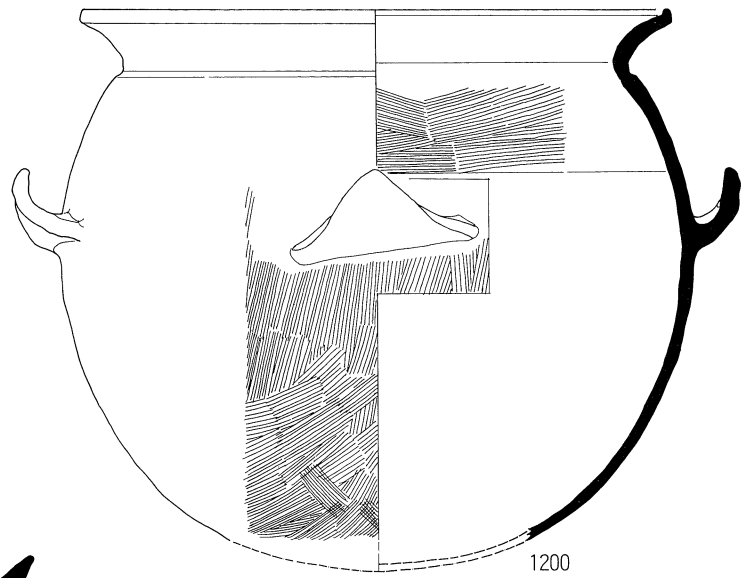
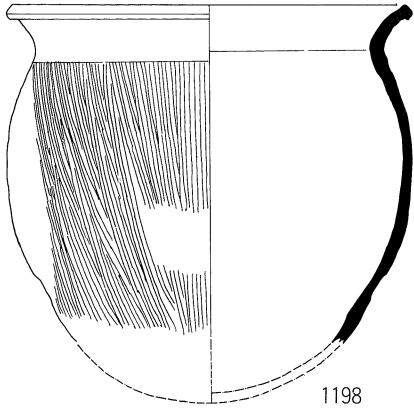
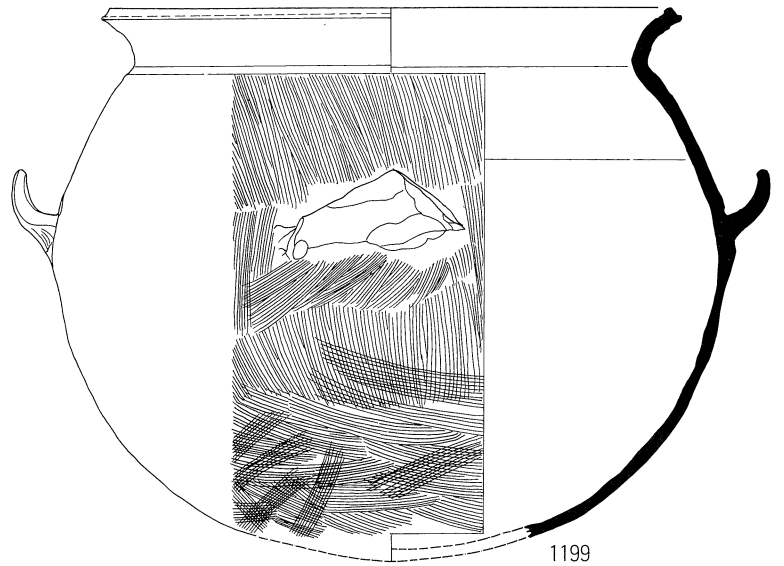
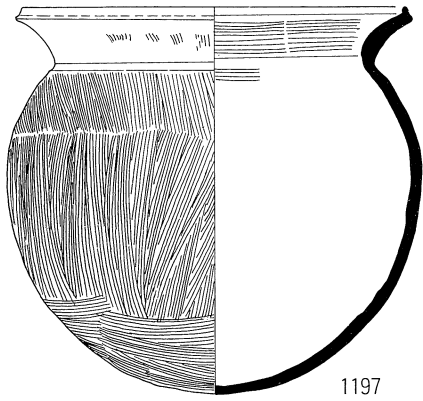

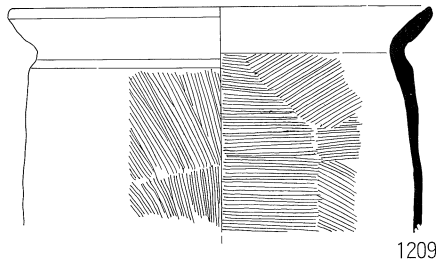

1209

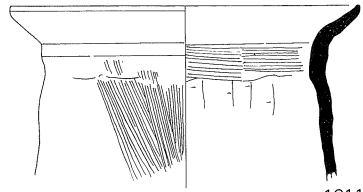

1211



1213

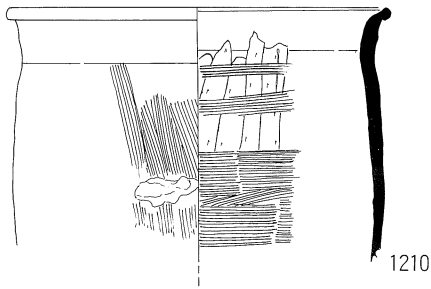

1210

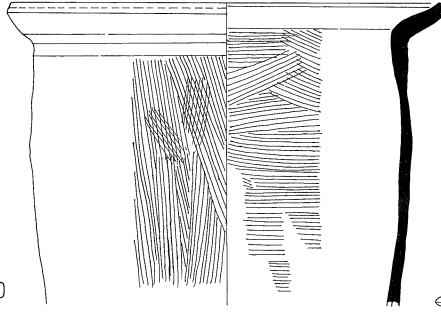

1212

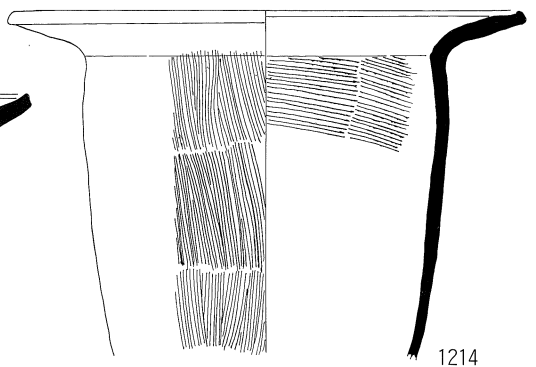

1214

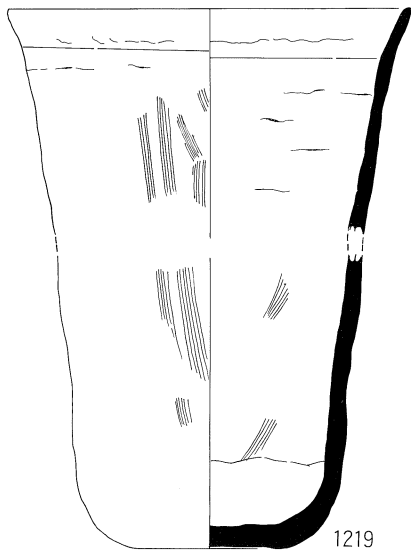

1219

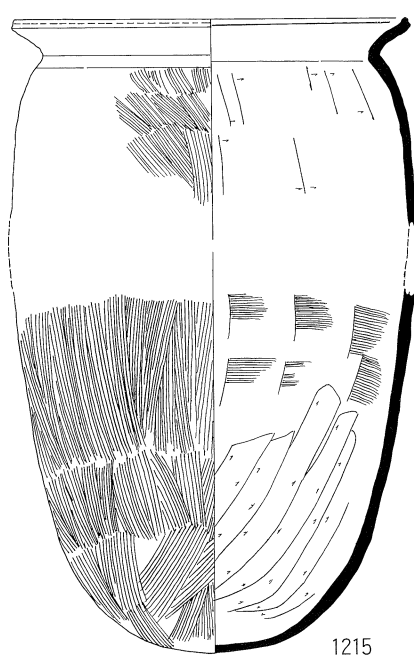

1215

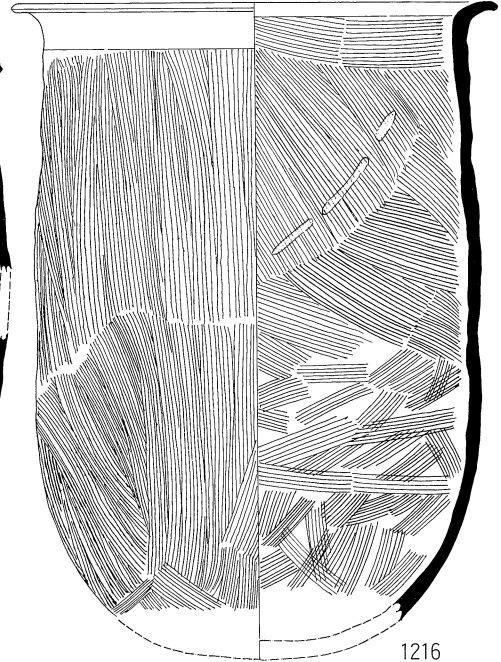

1216

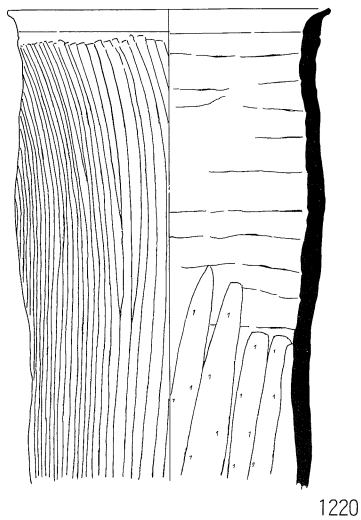

1220

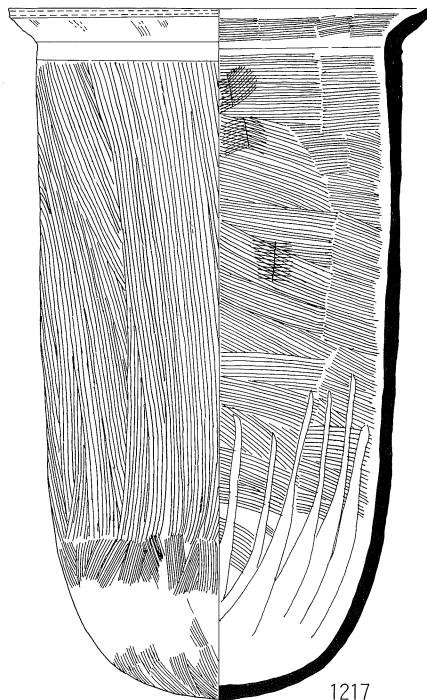

1217

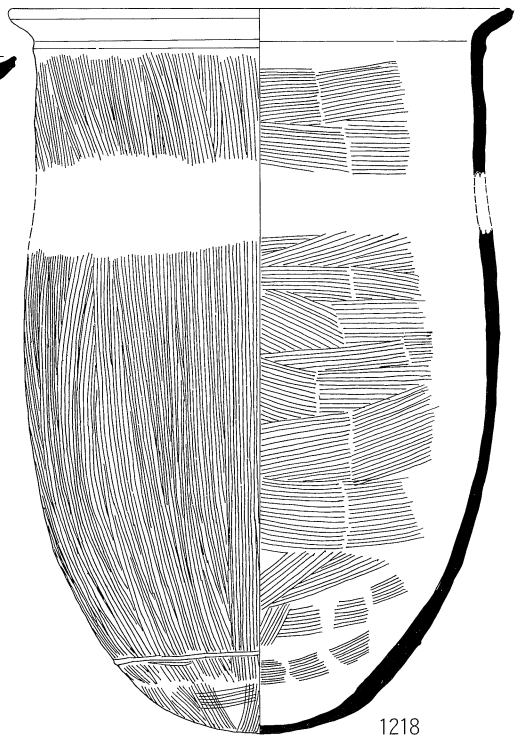

1218

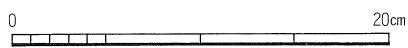

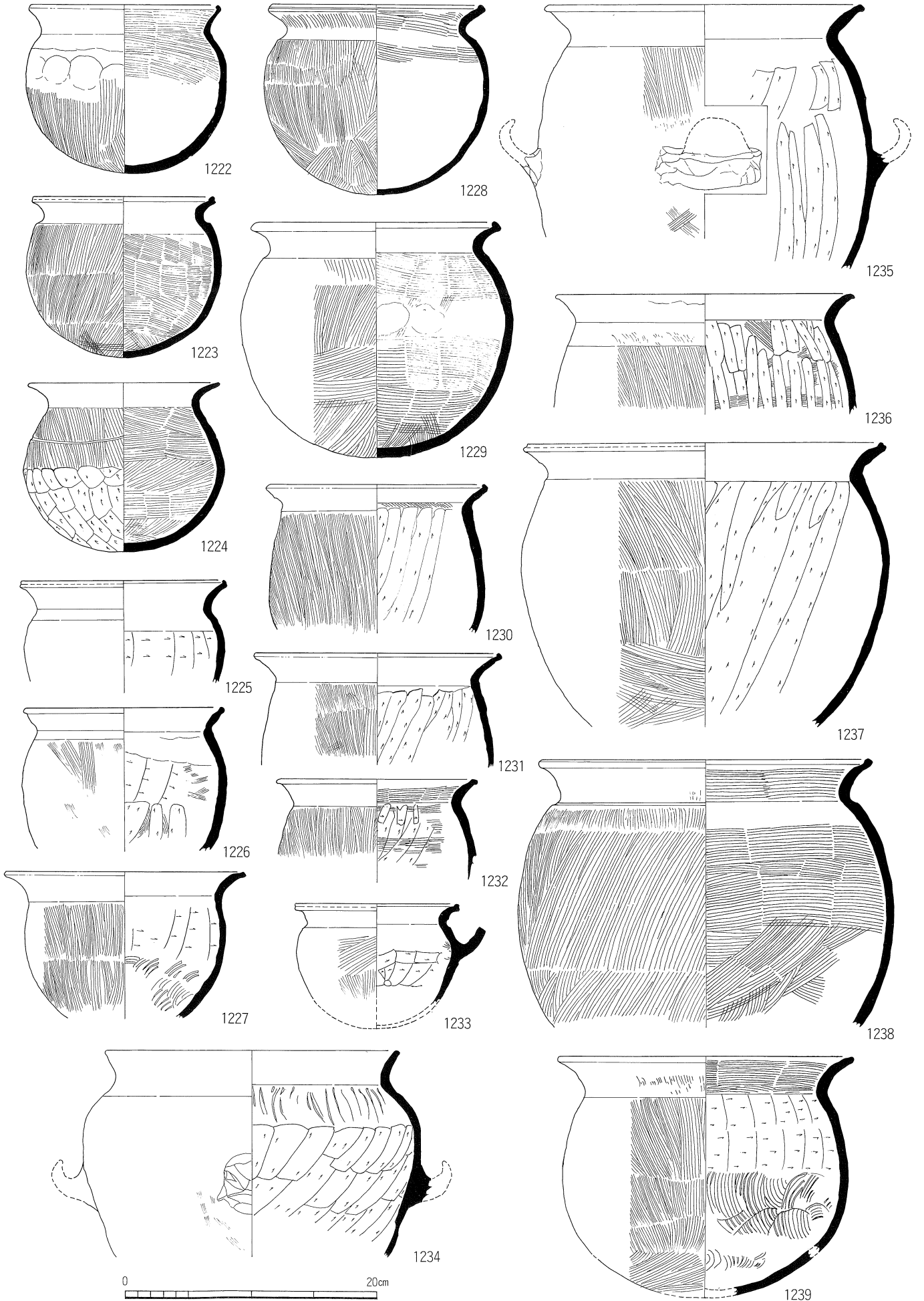

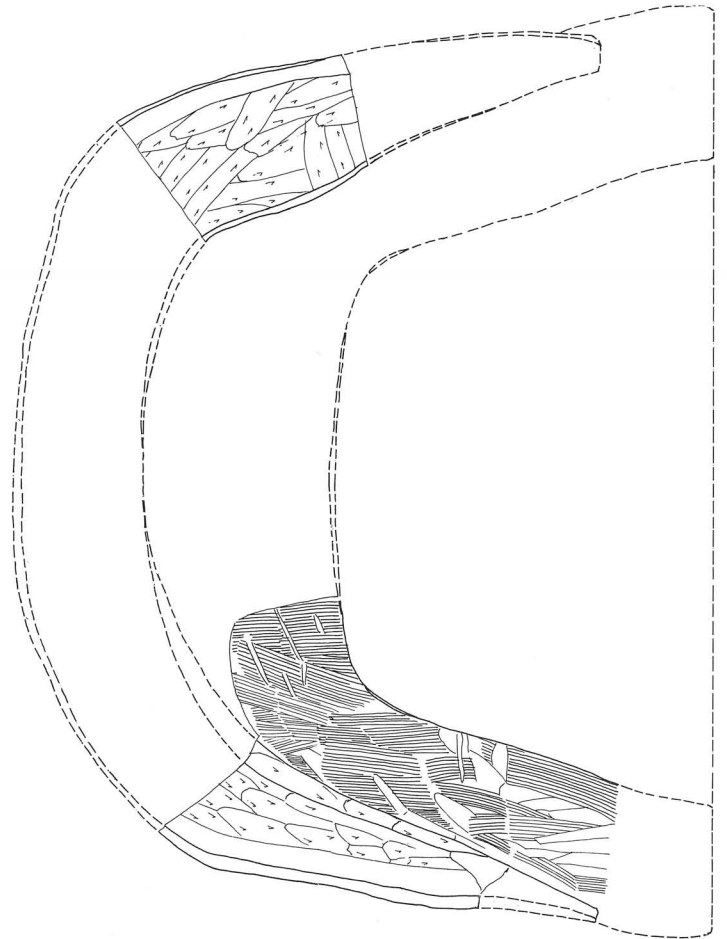
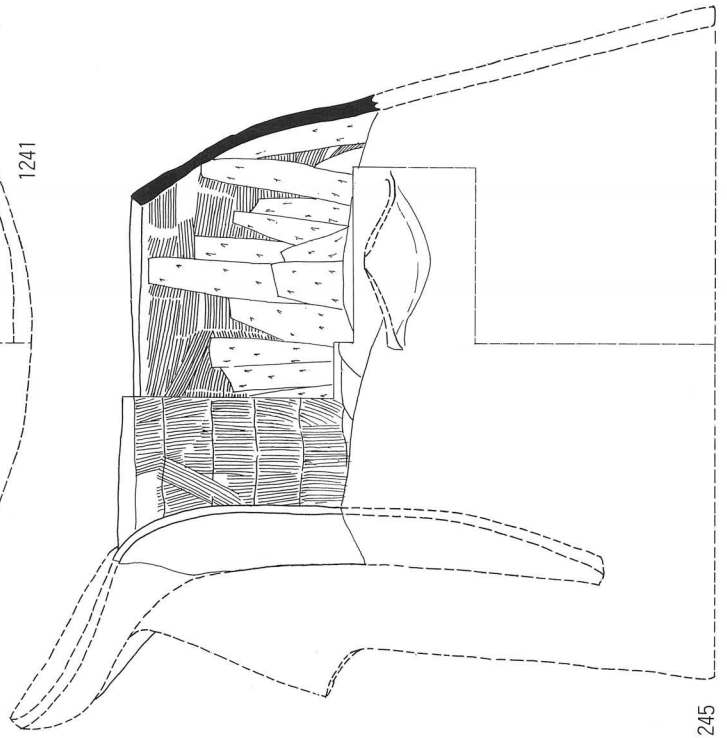
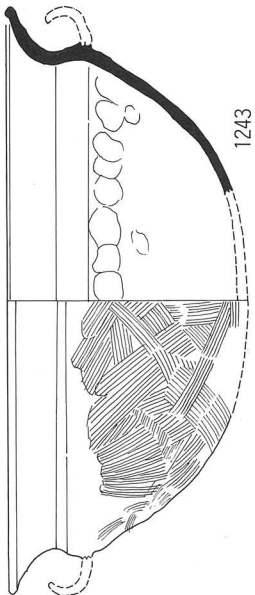
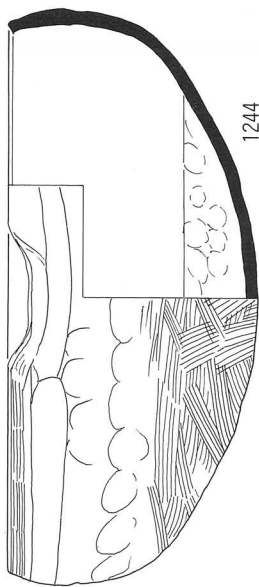
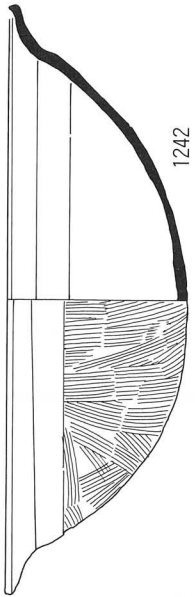
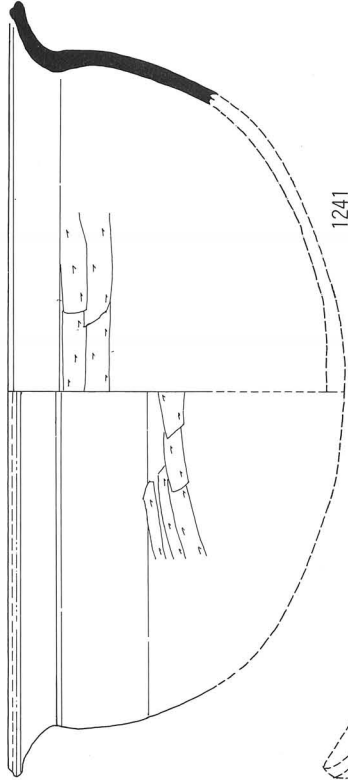
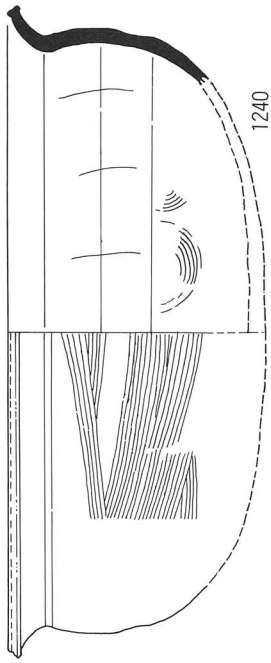

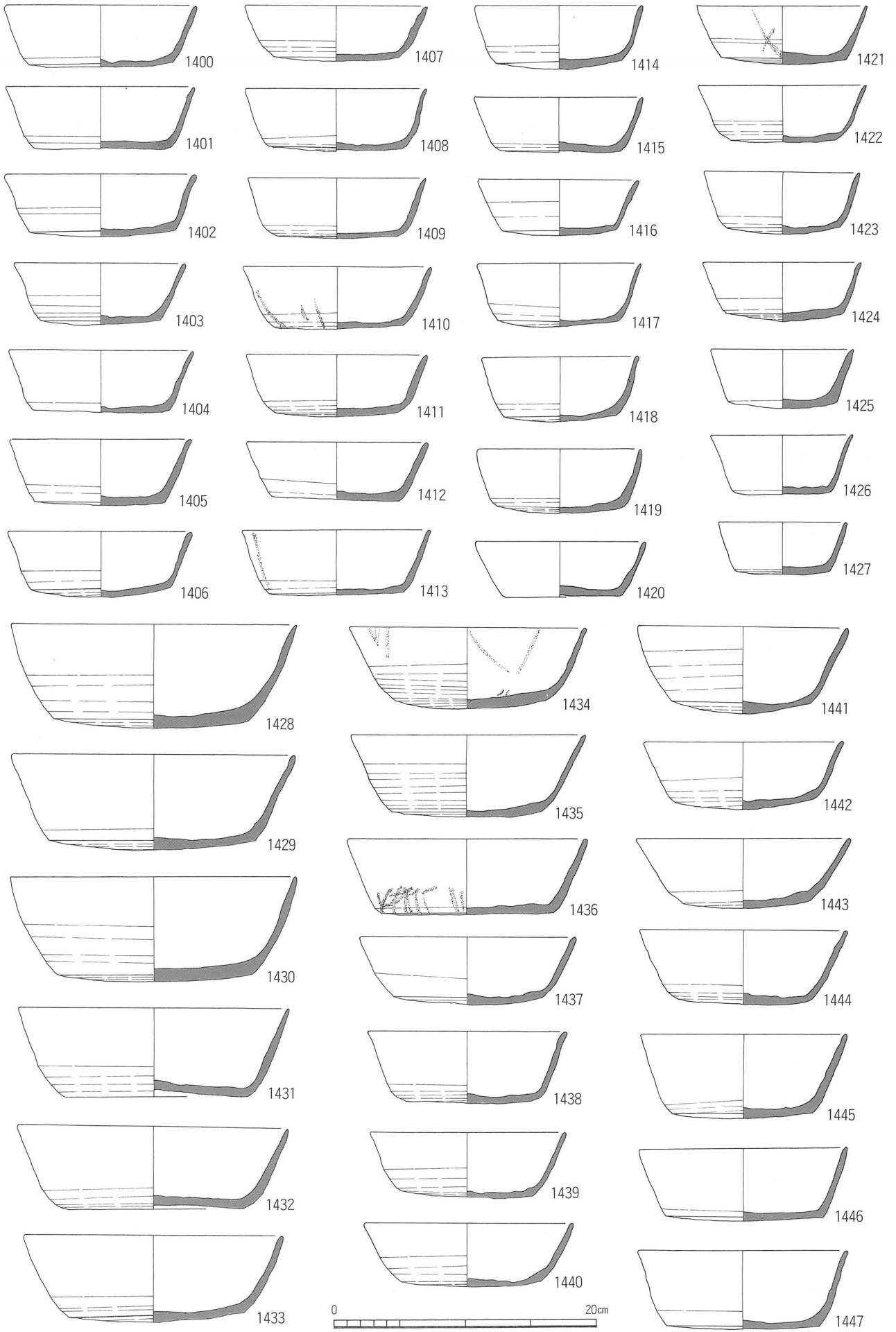

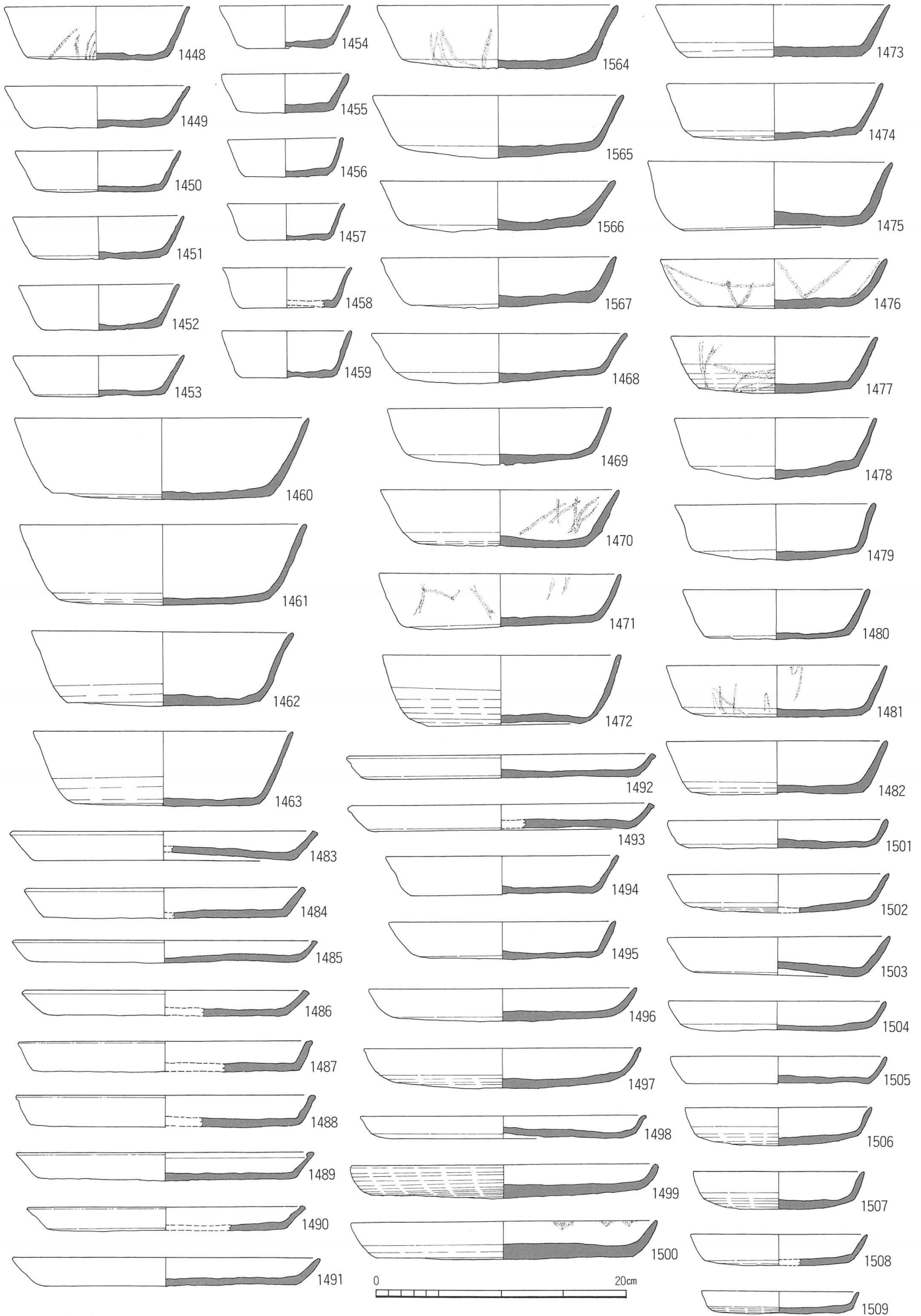

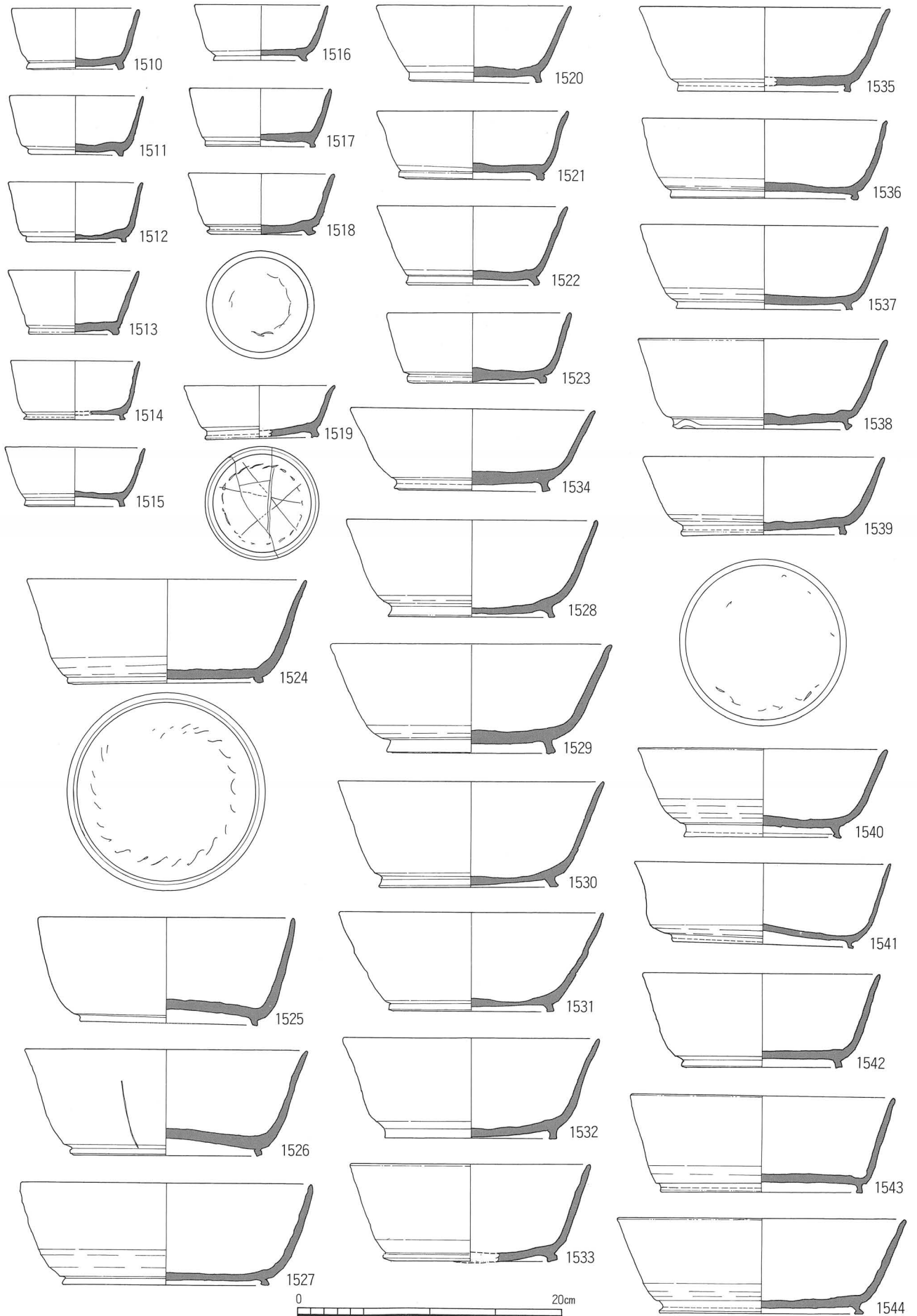

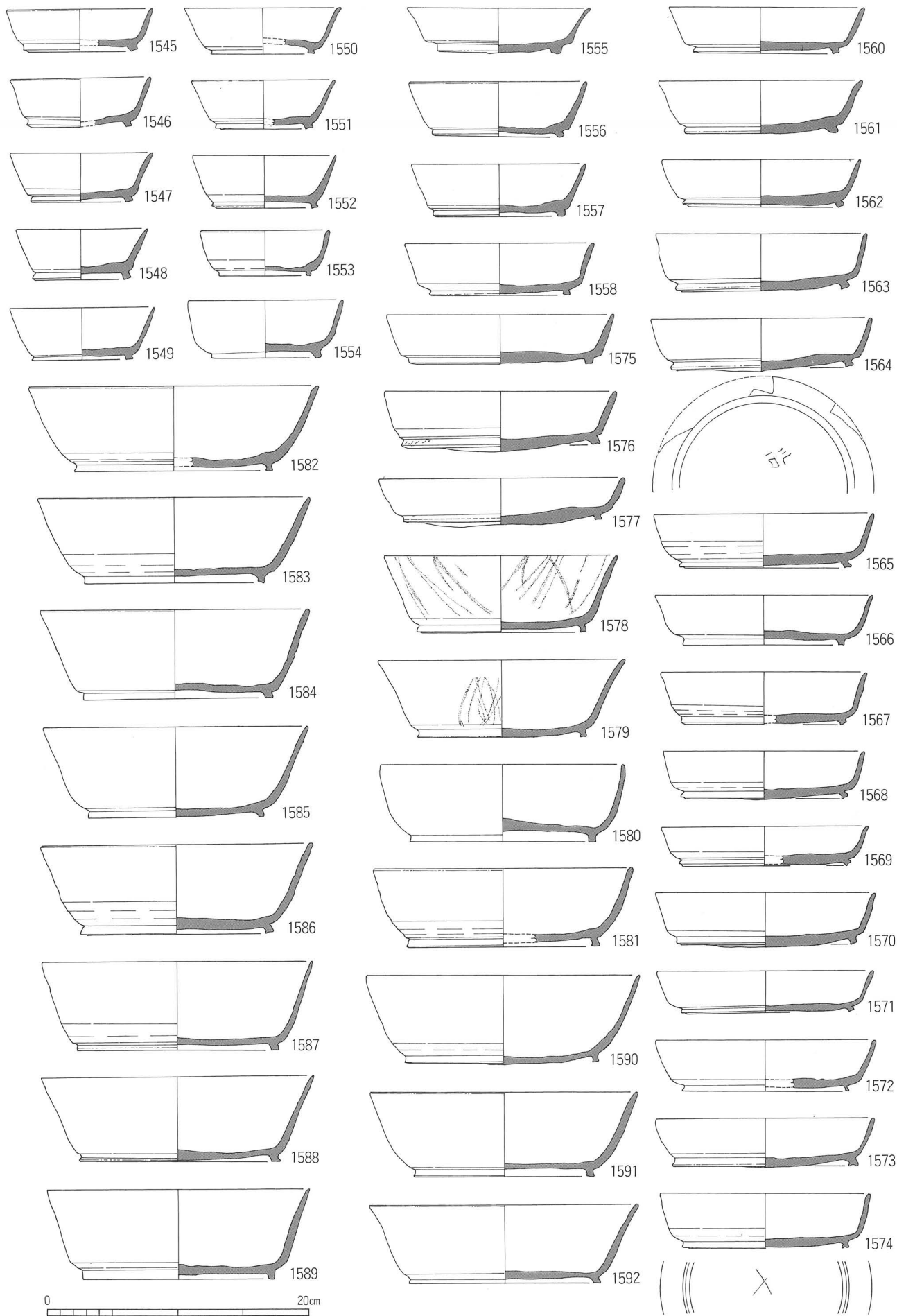

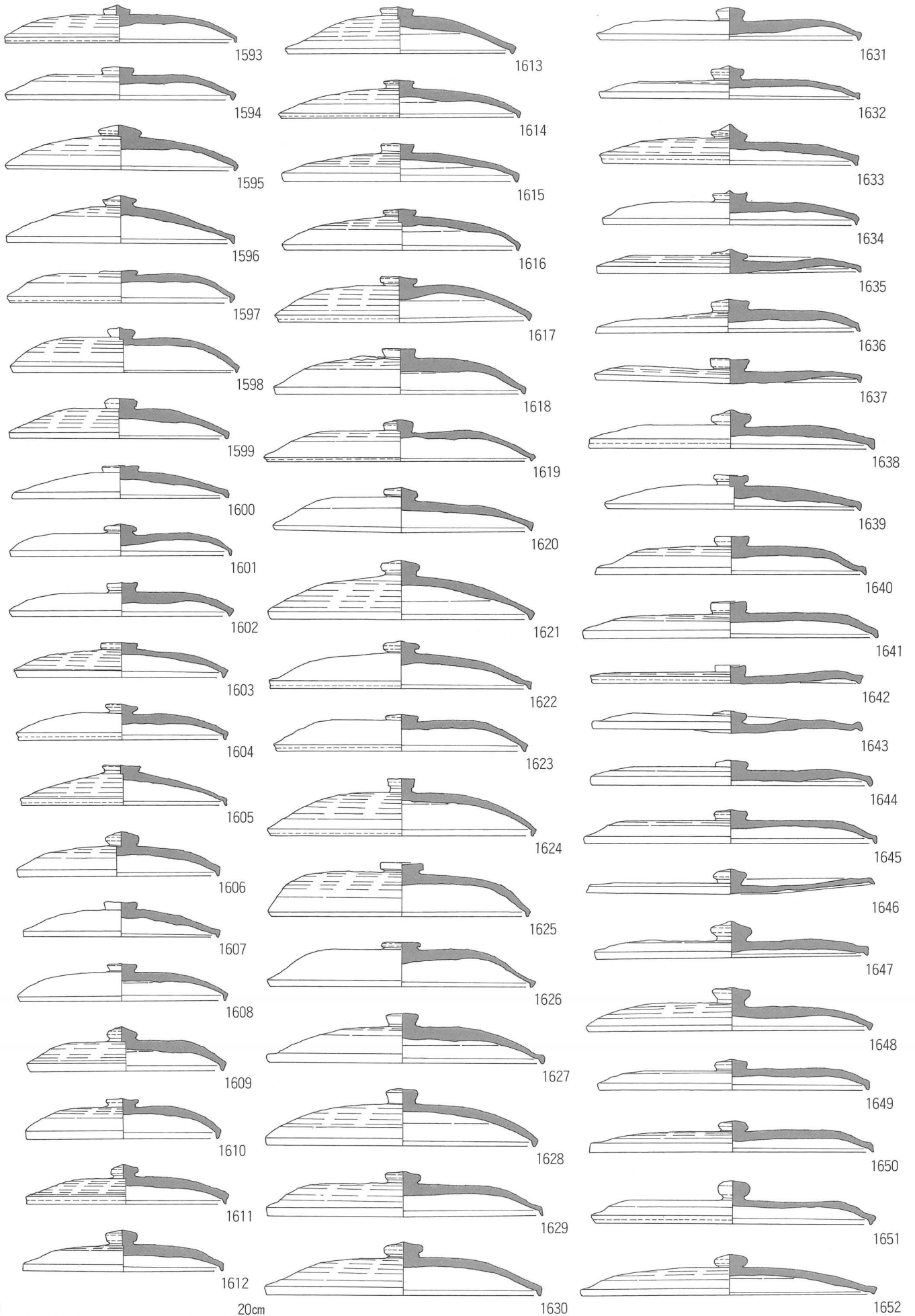

0 20cm

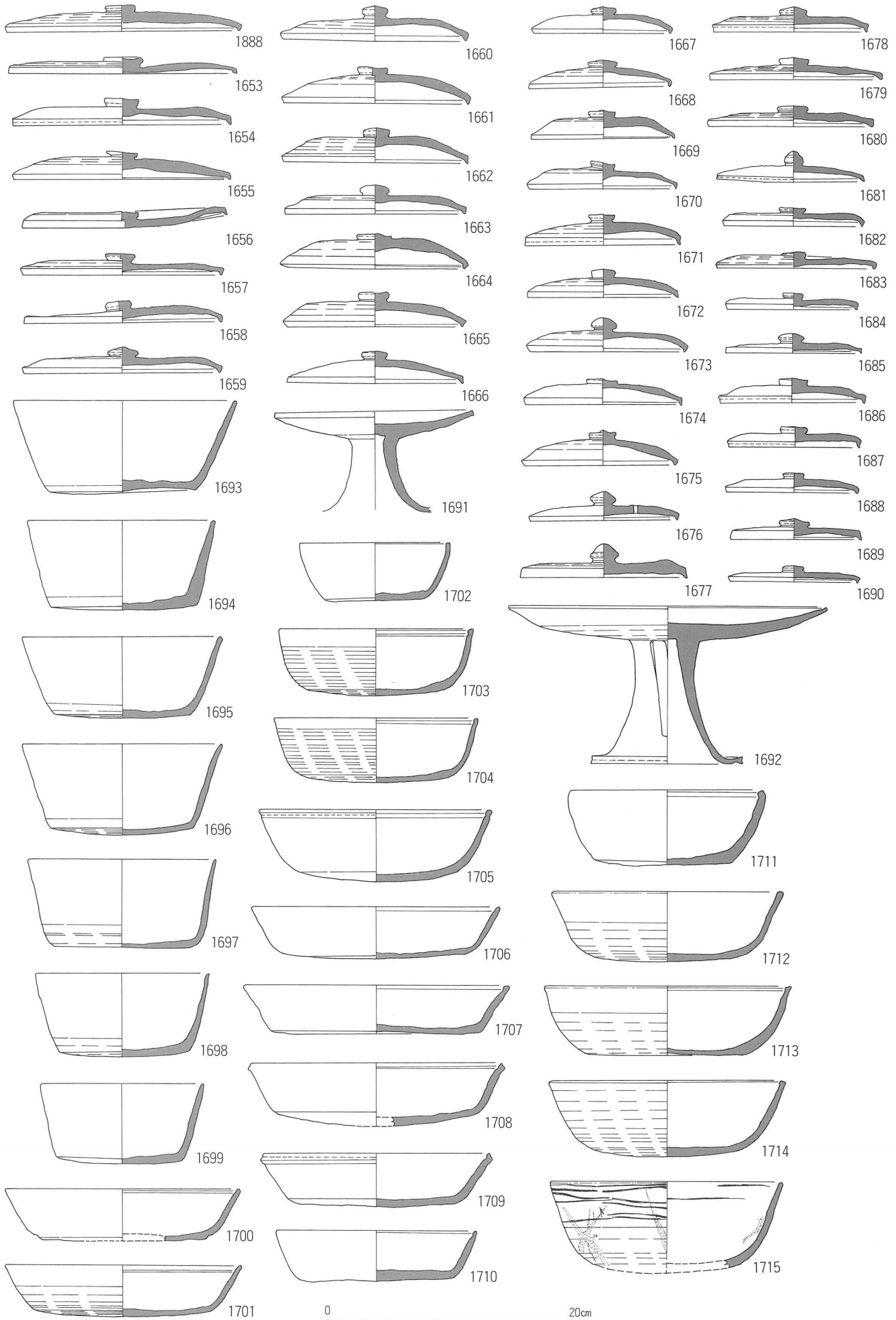

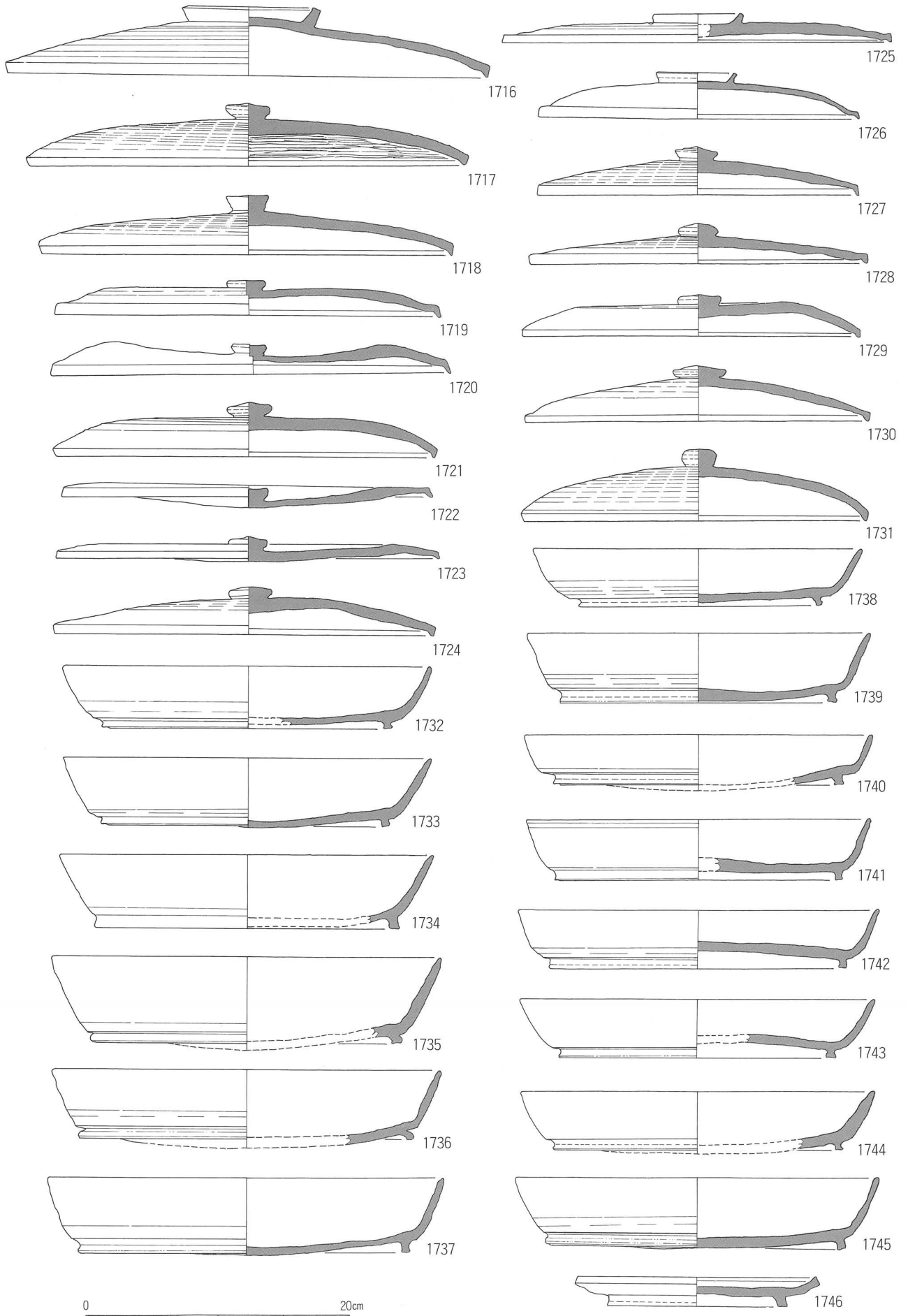

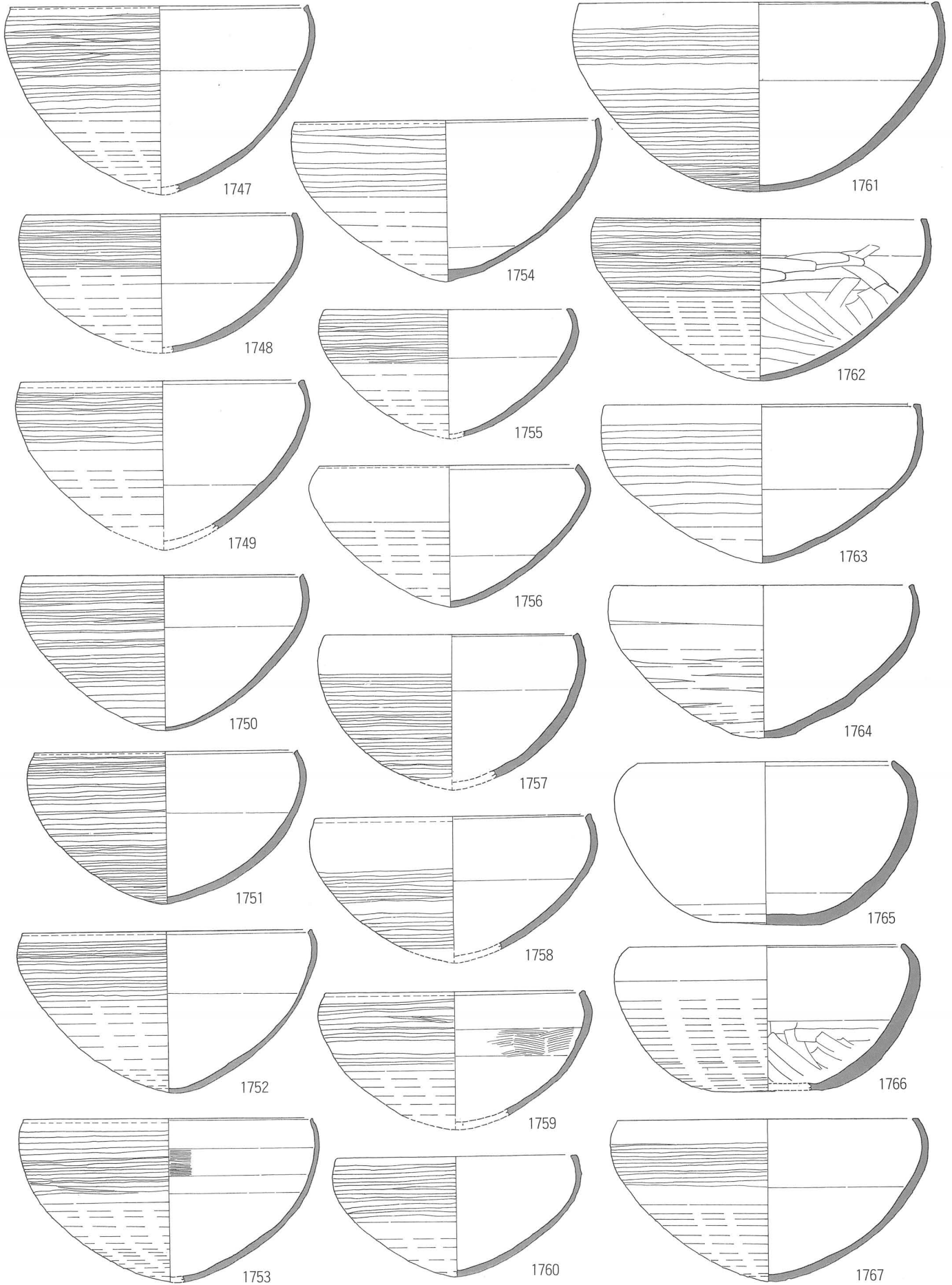

1 : 4

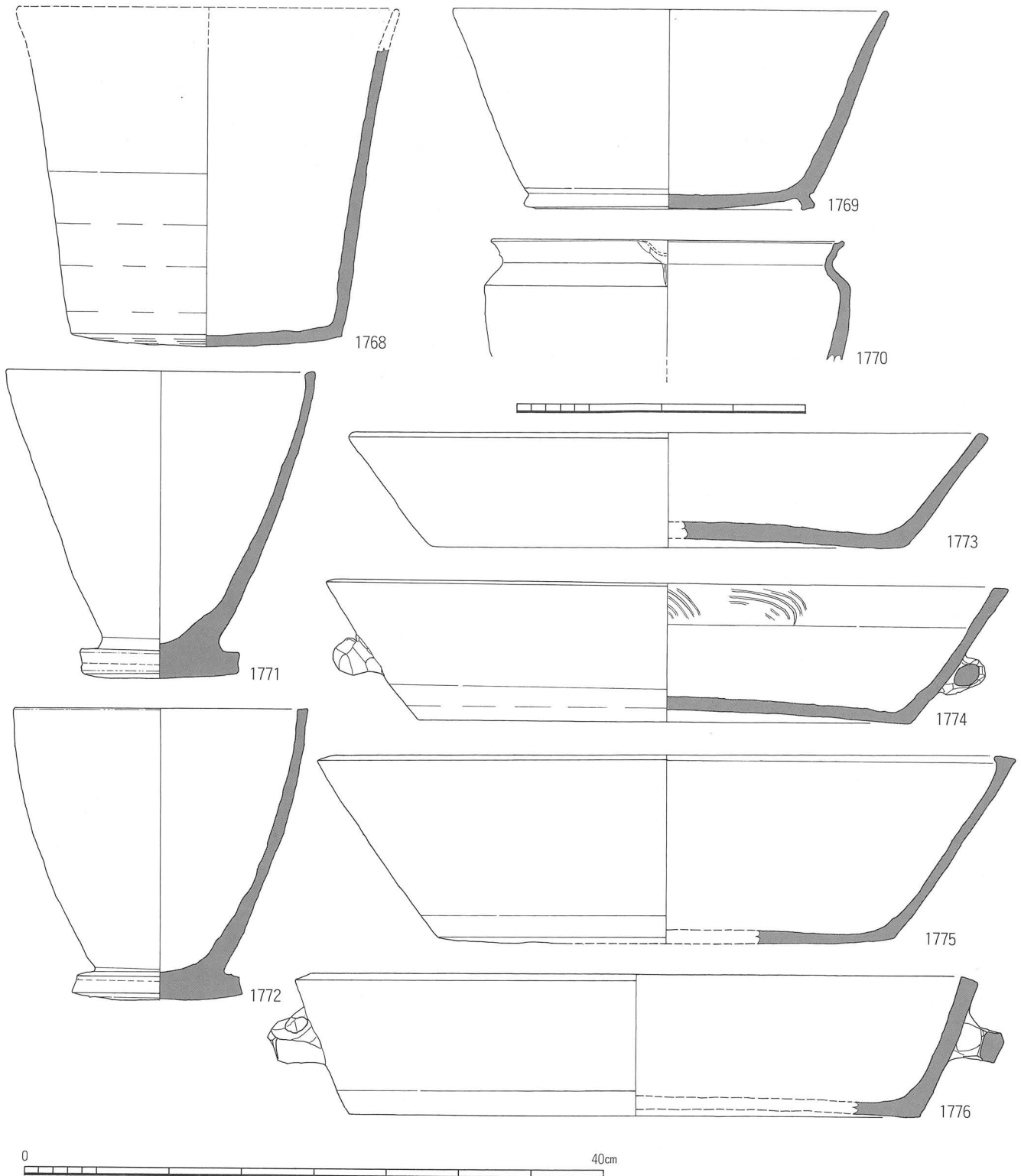

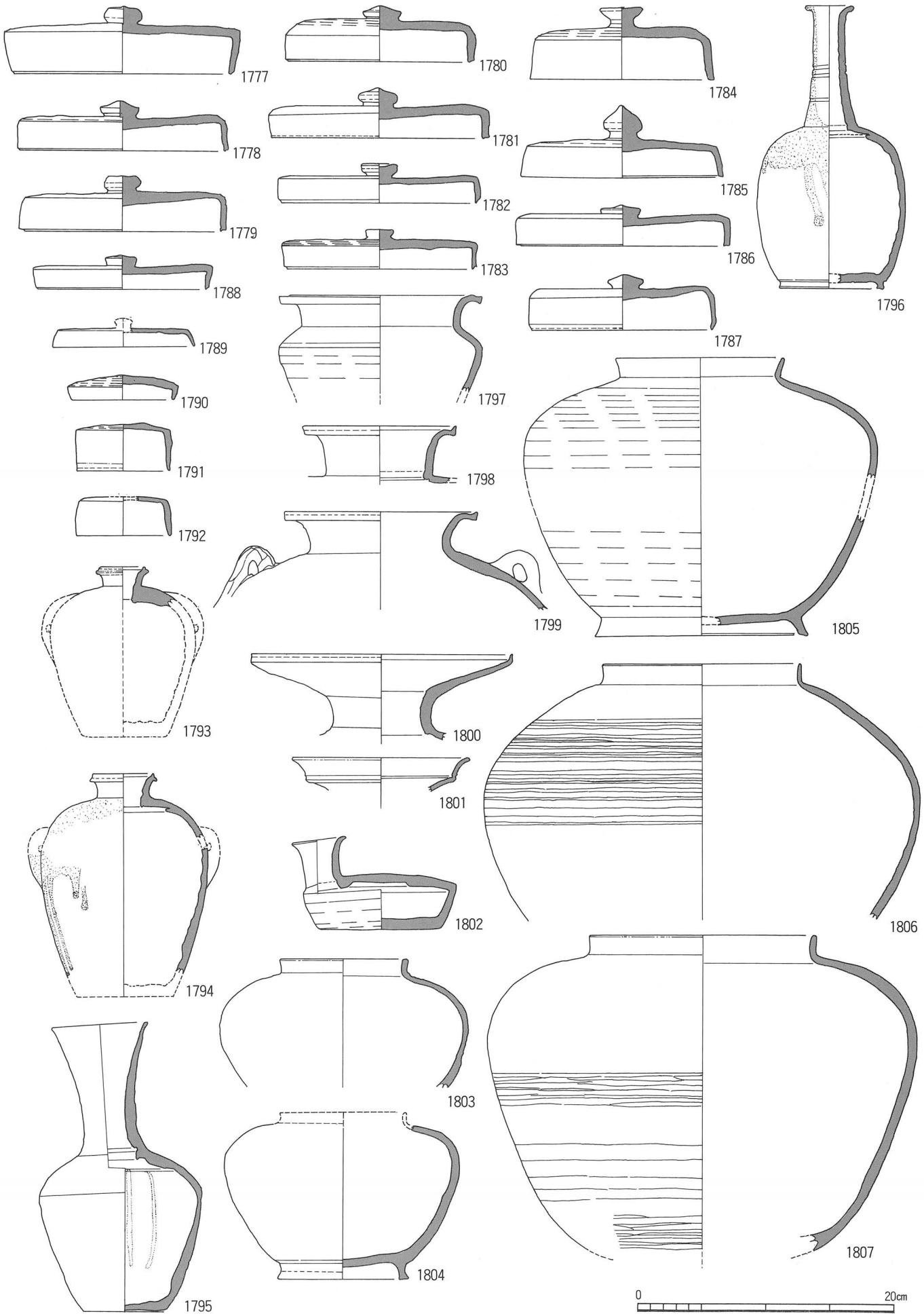

0 20cm

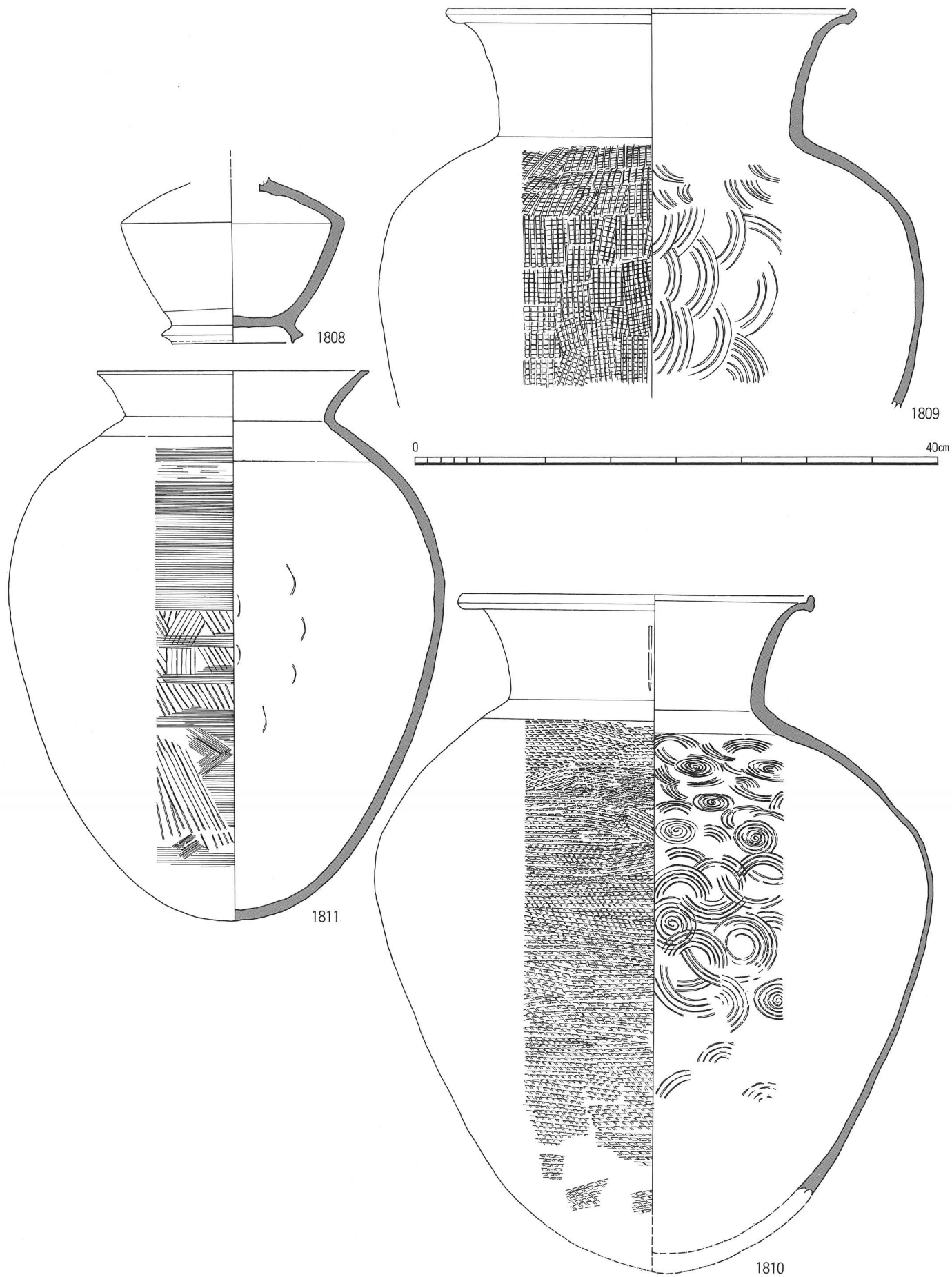

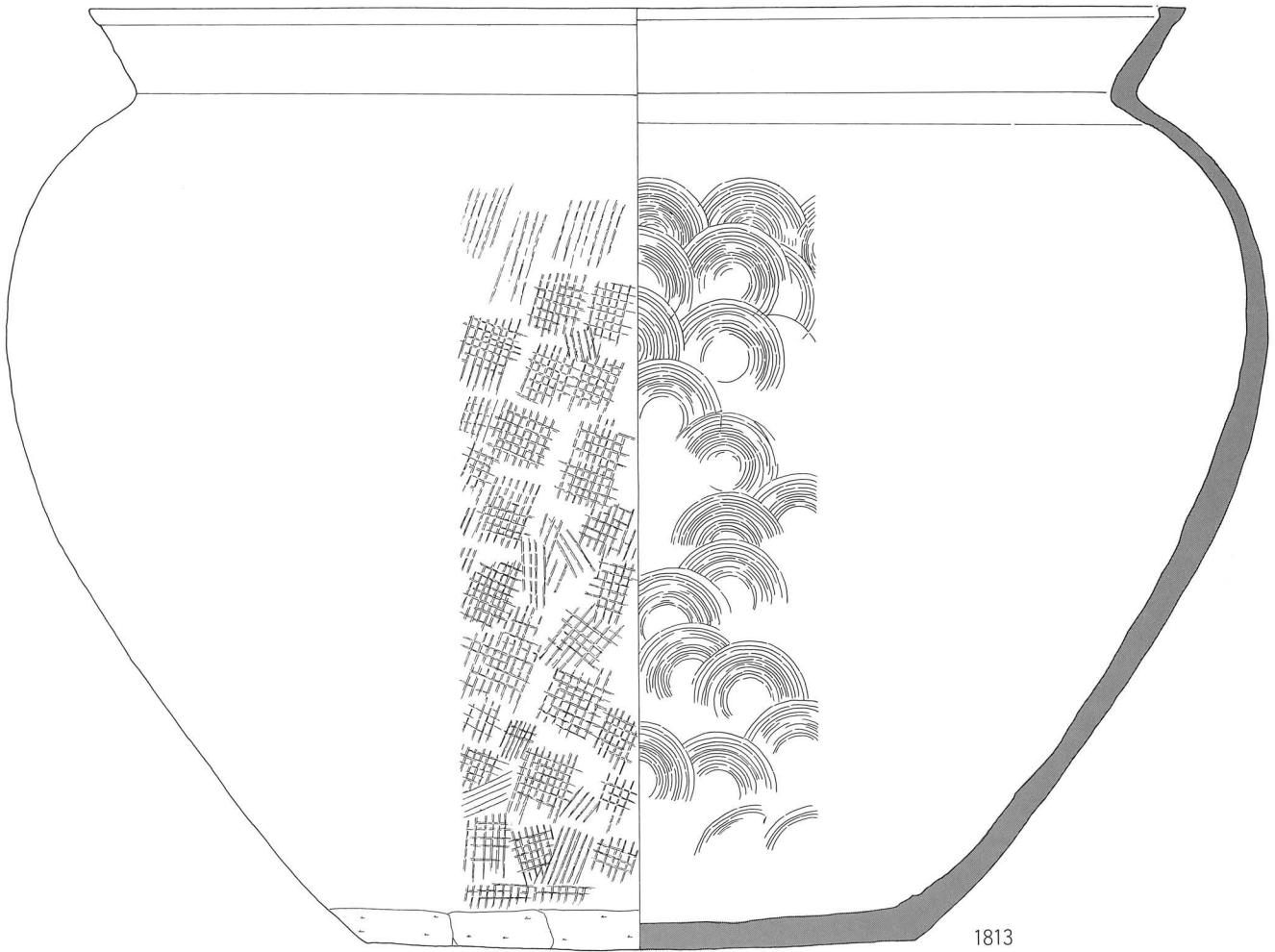
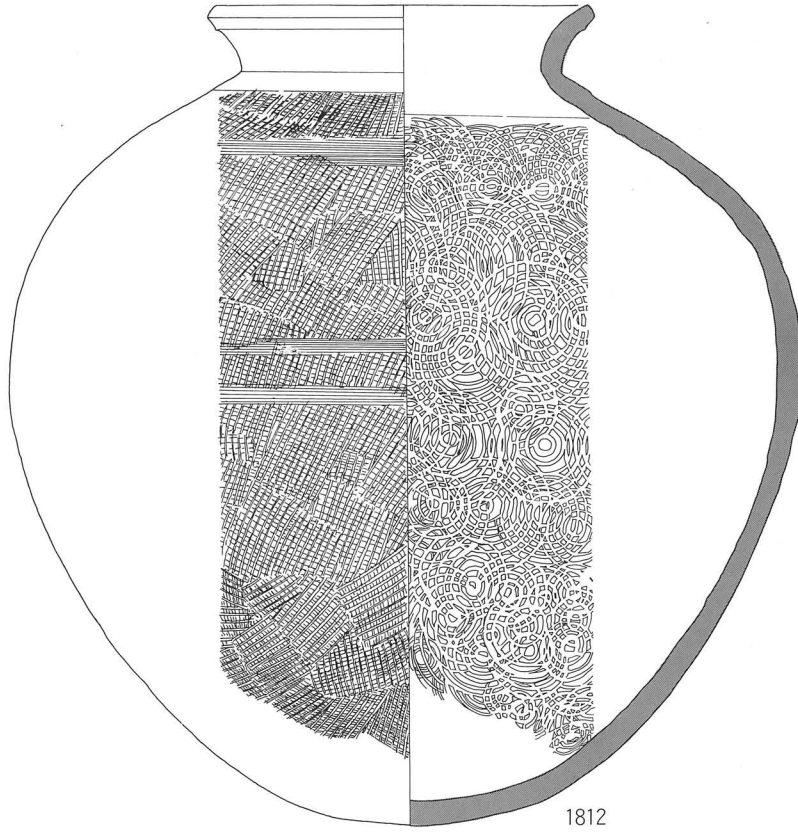

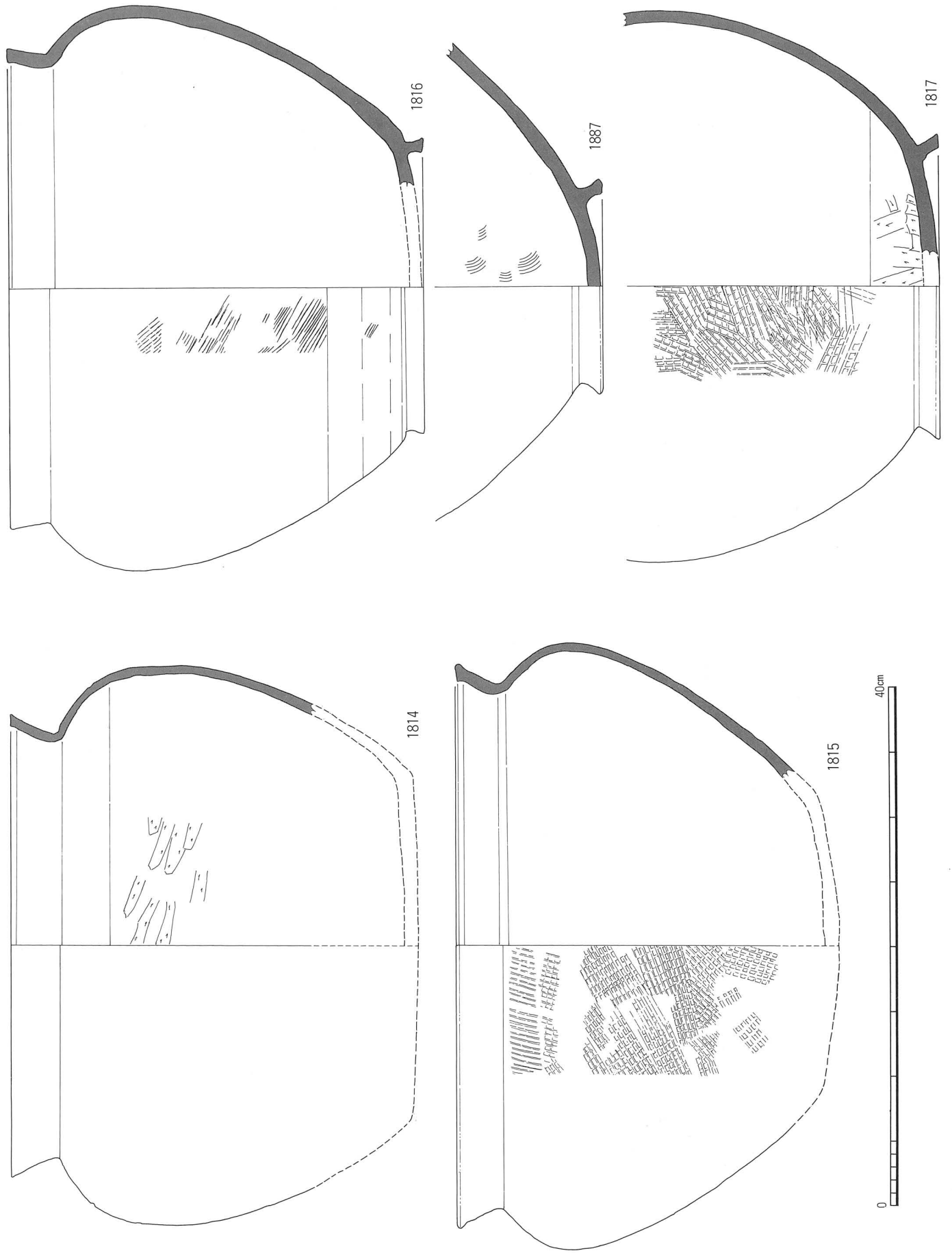

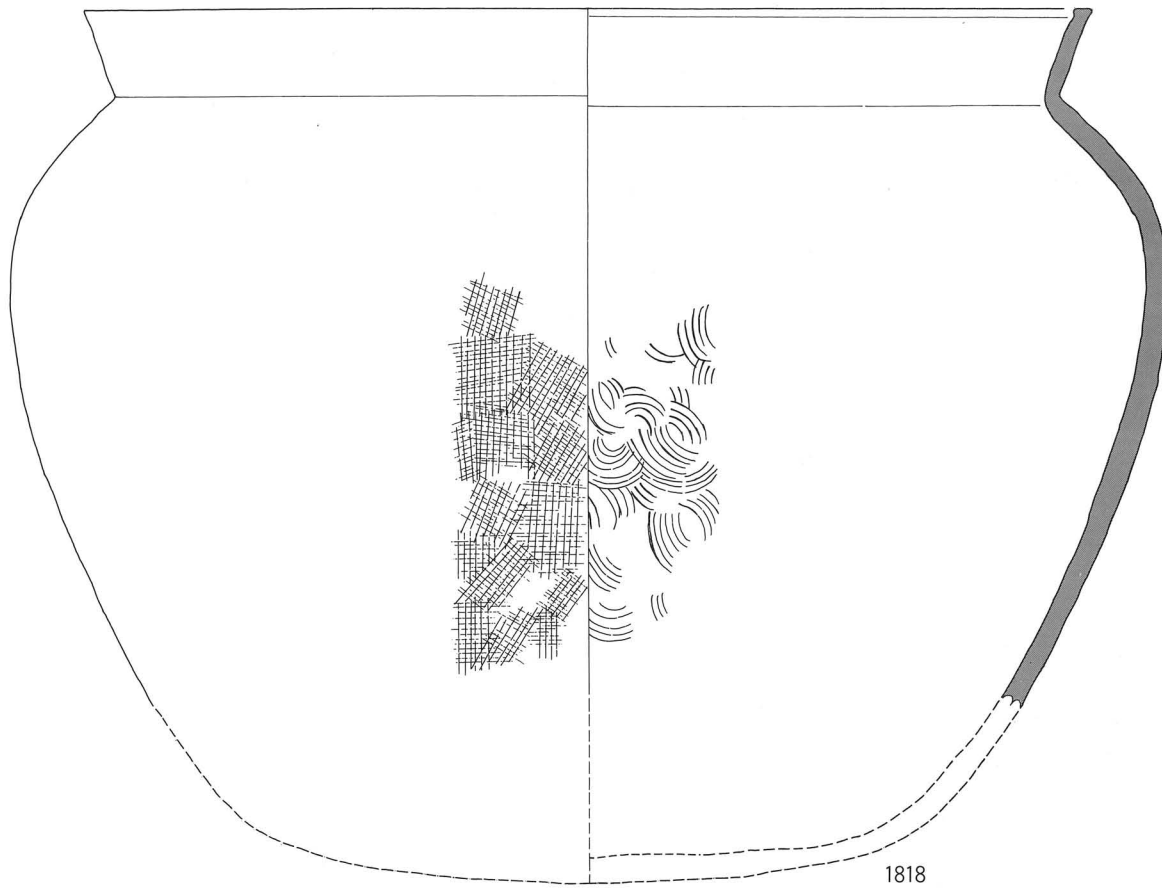

1:4

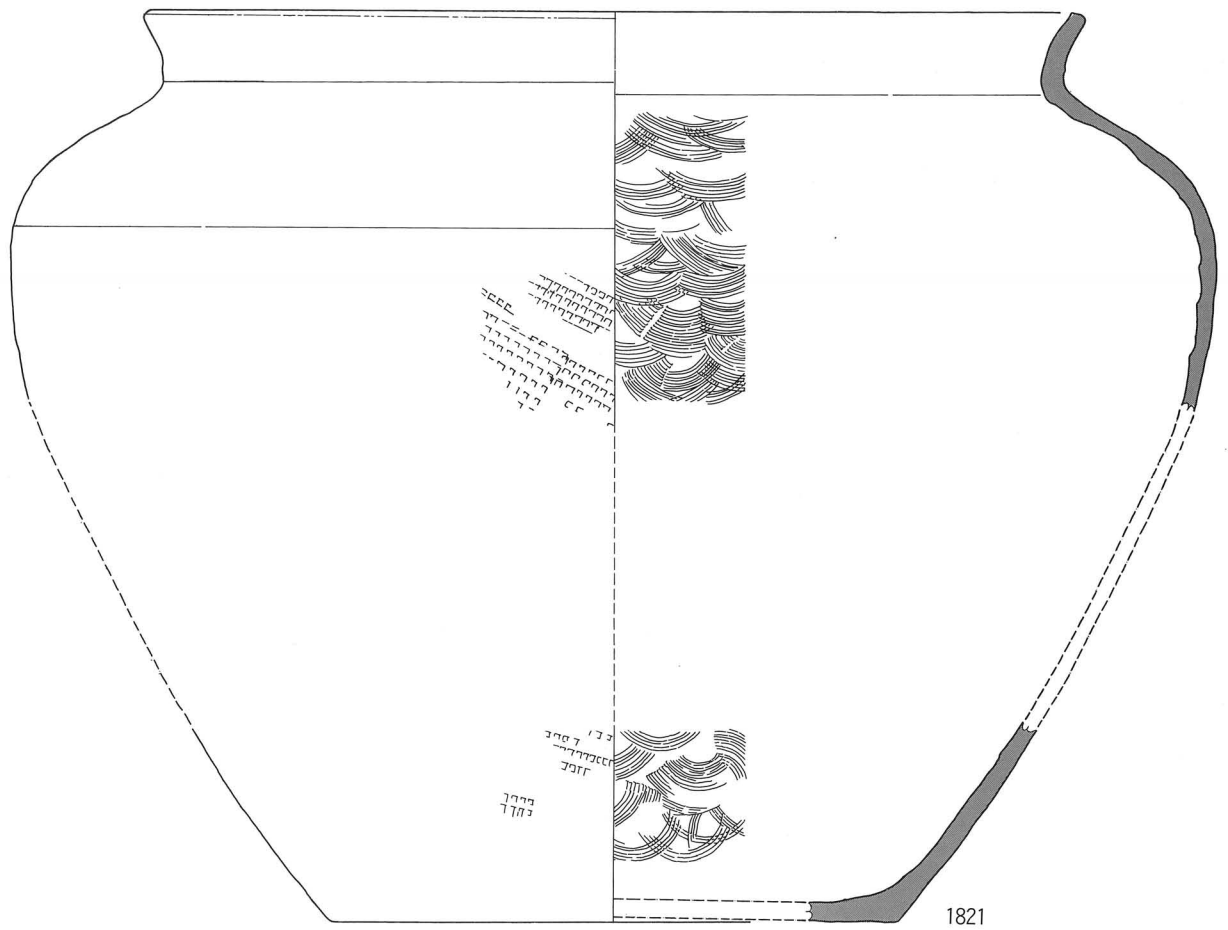
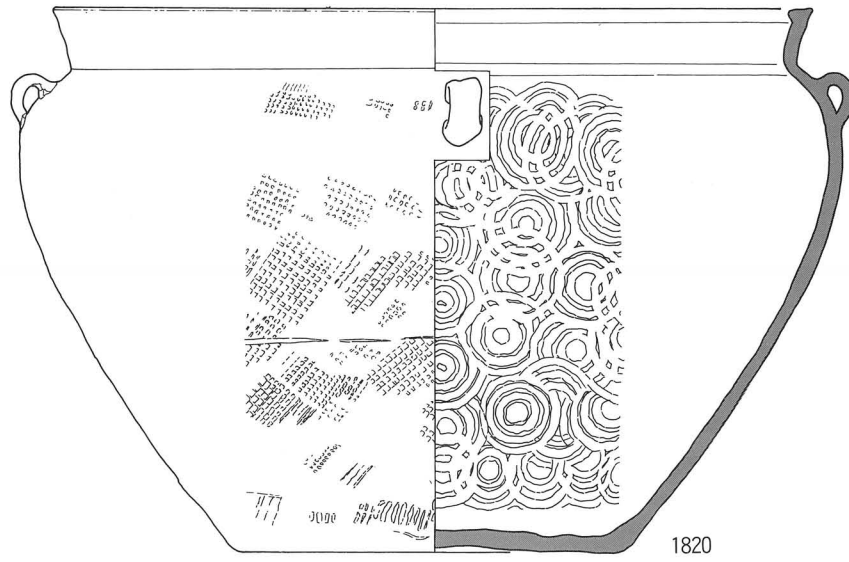

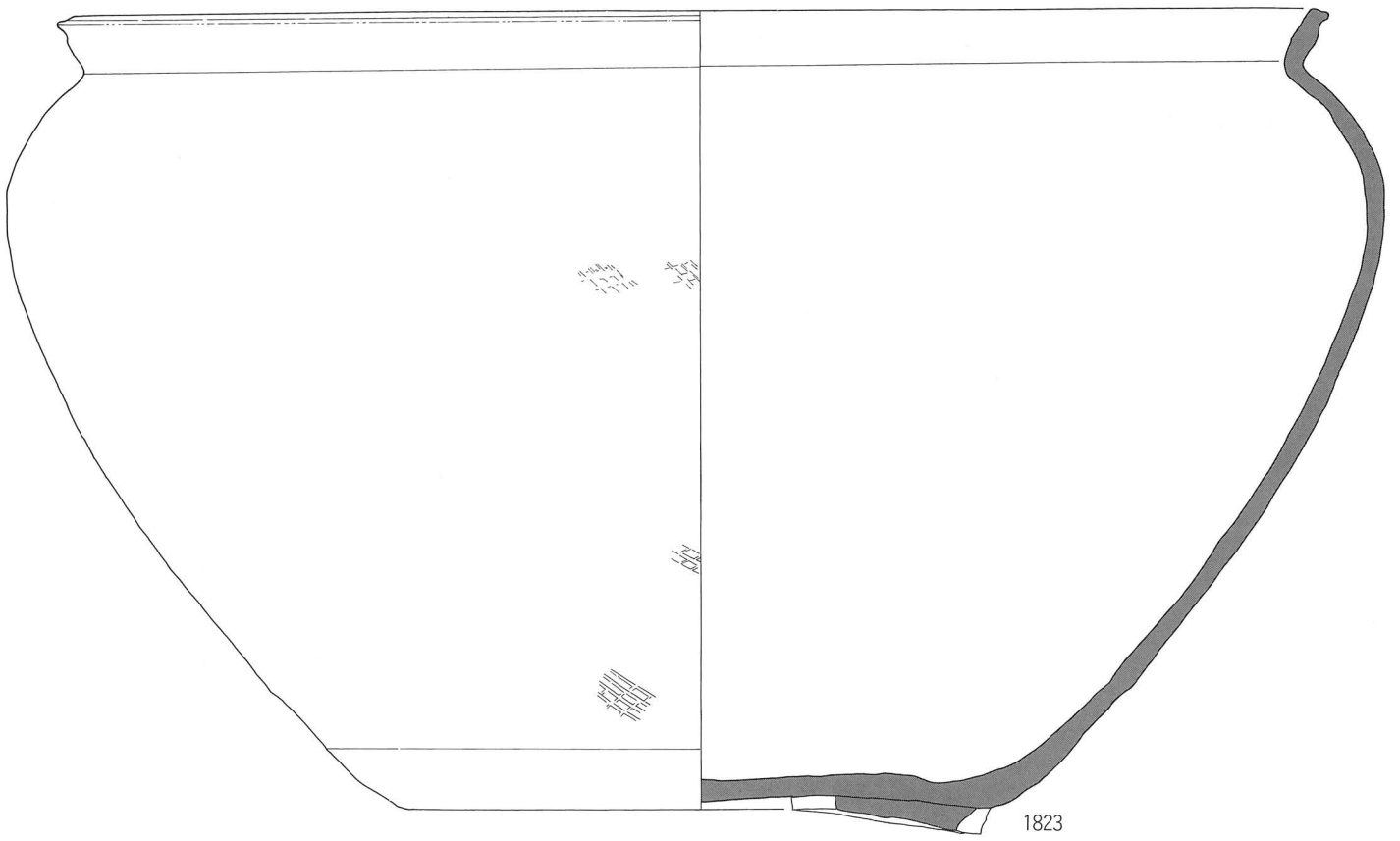
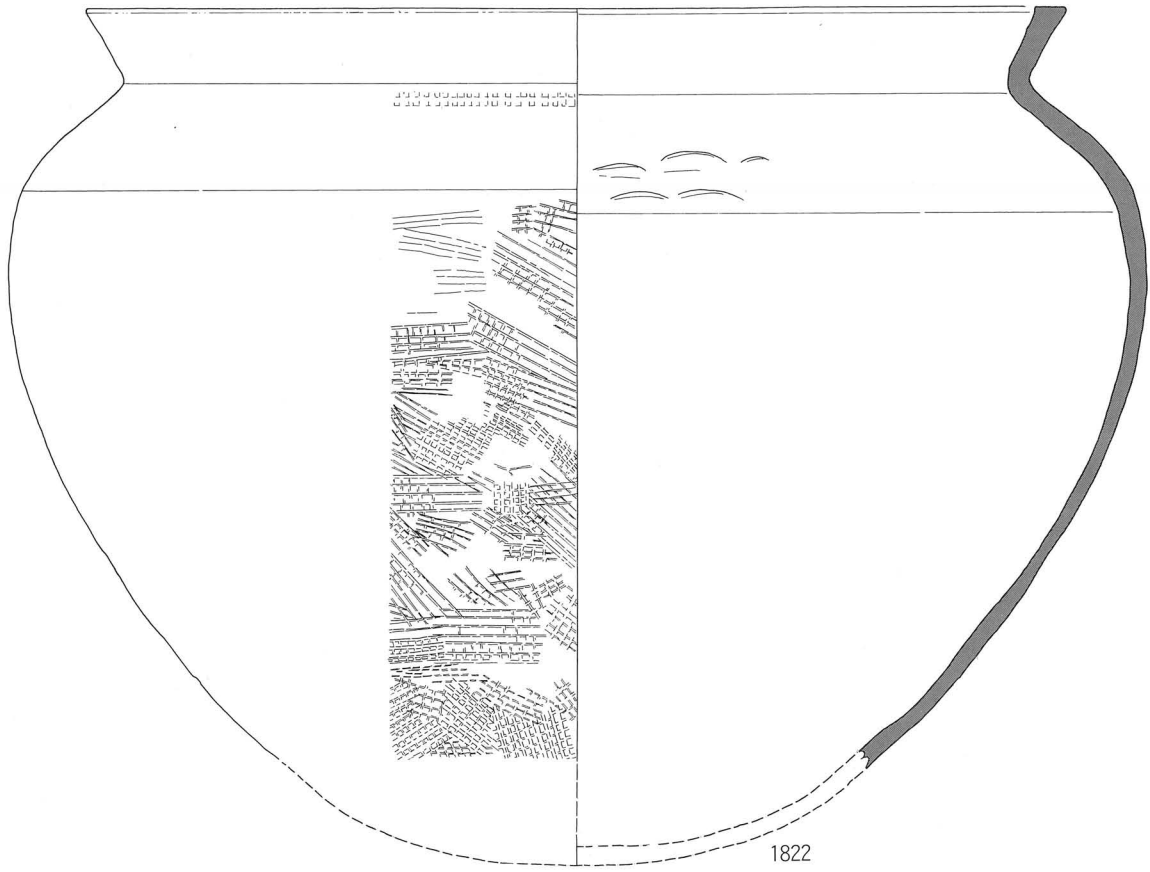

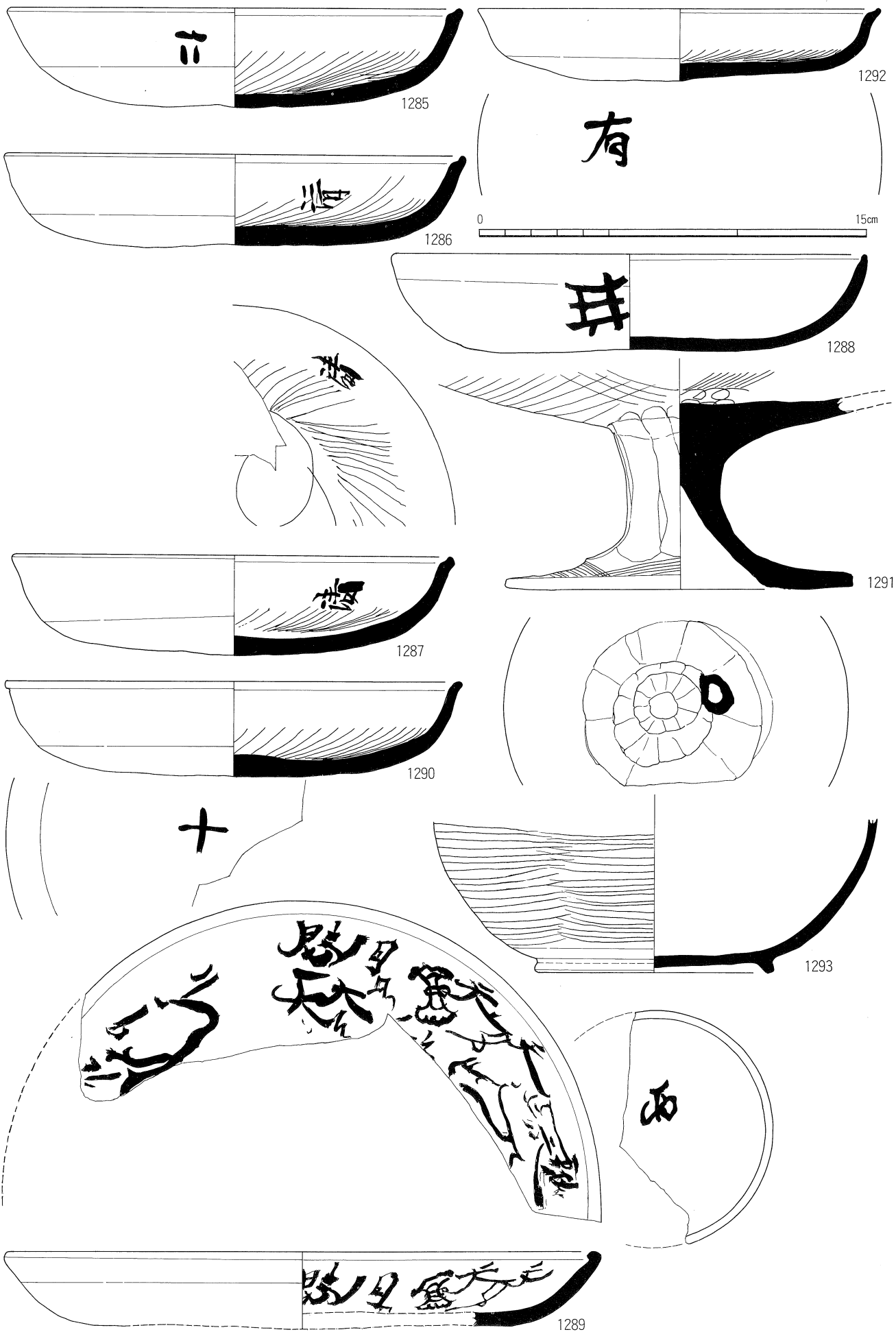

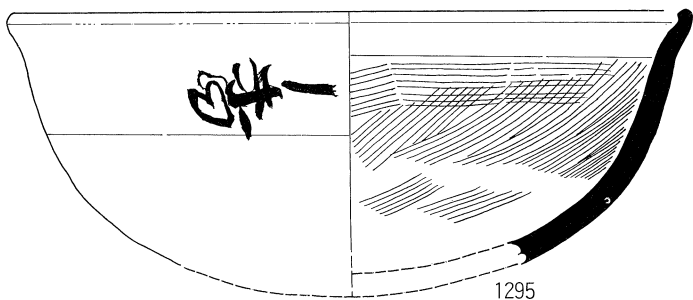
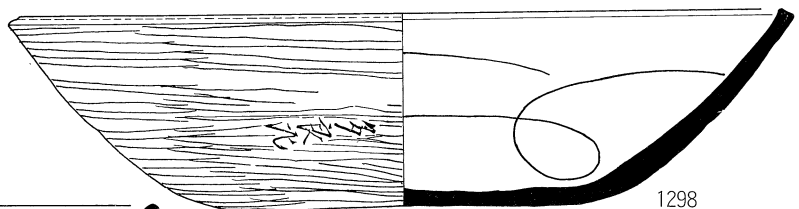
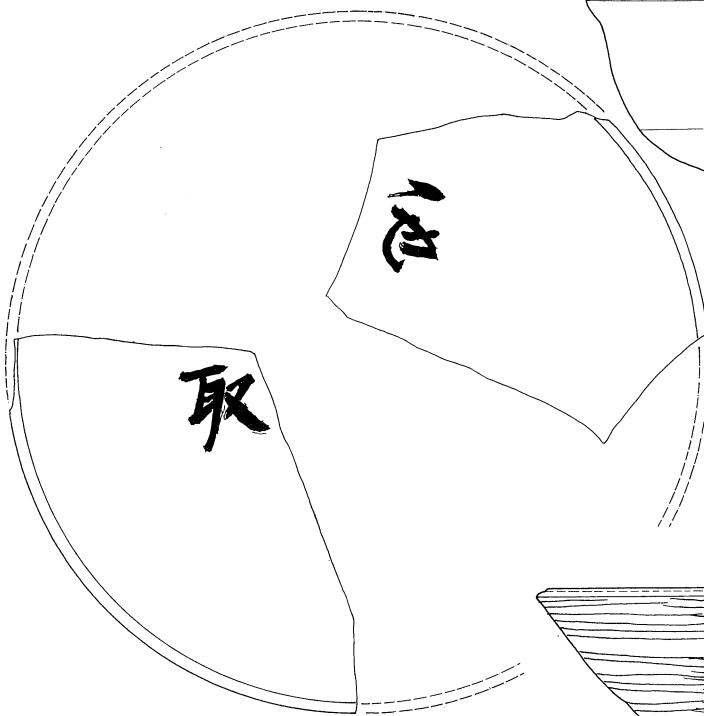
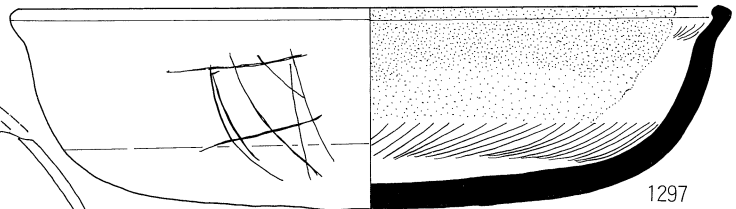
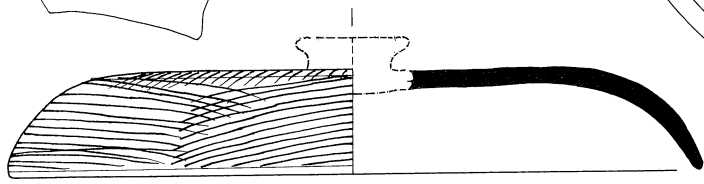
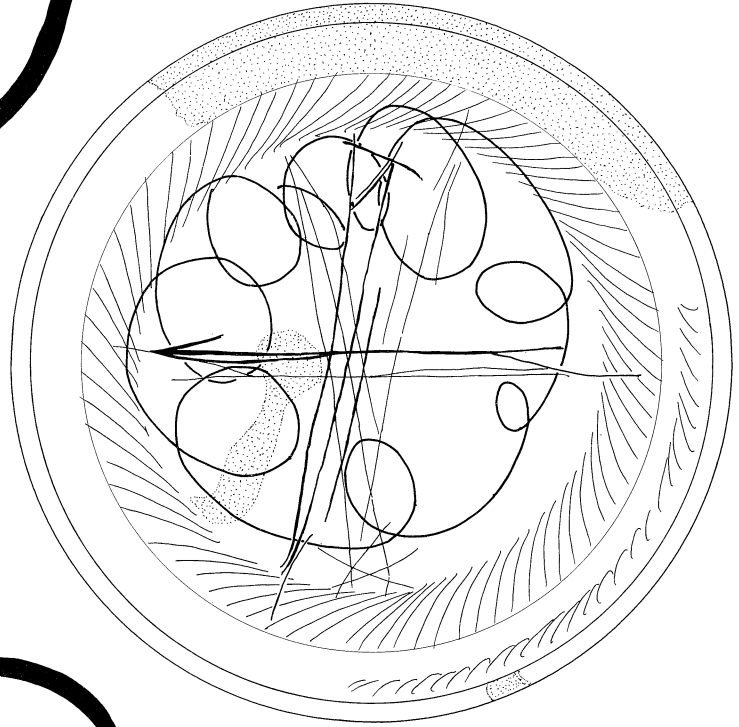
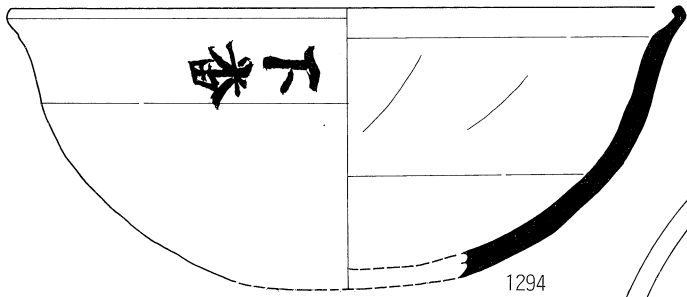

1298 1:4 その他1:2

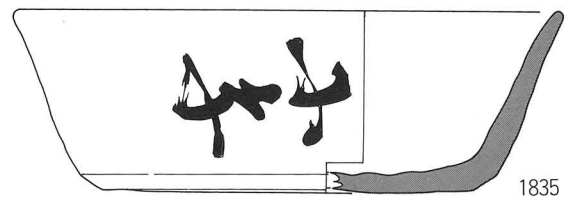
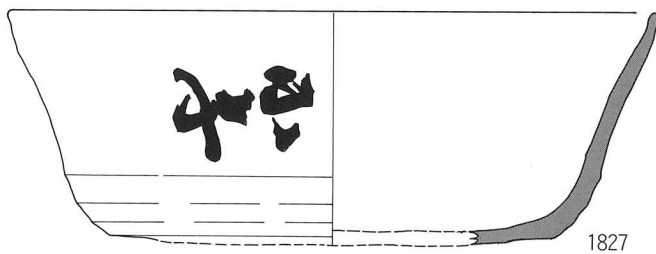
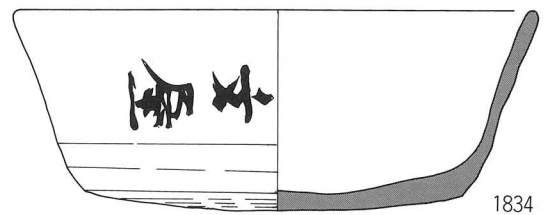
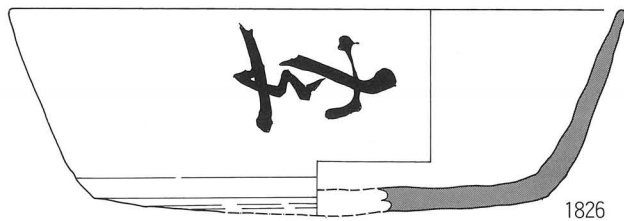
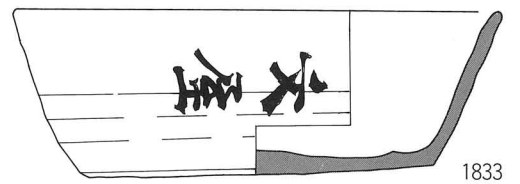
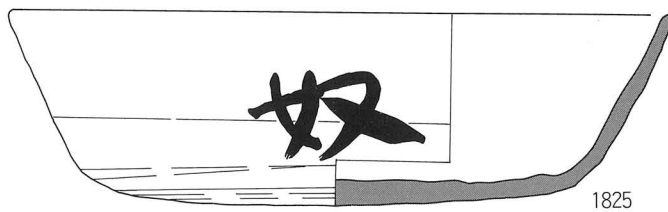
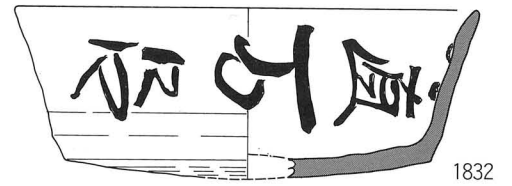
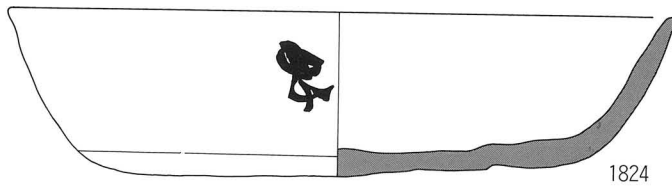
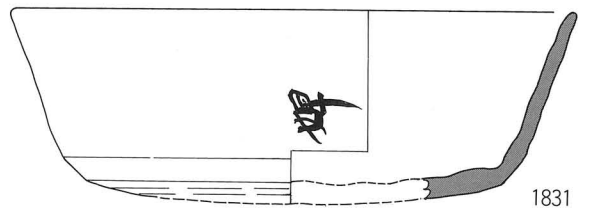
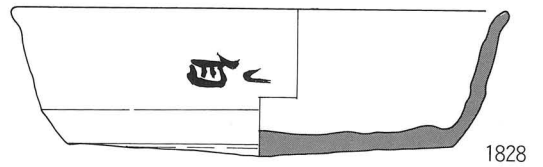
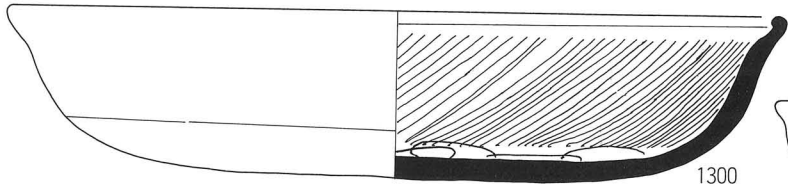
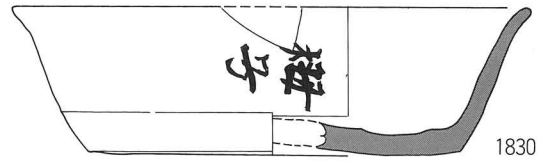
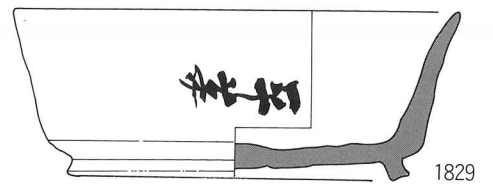
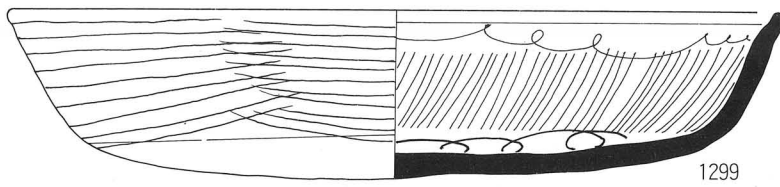

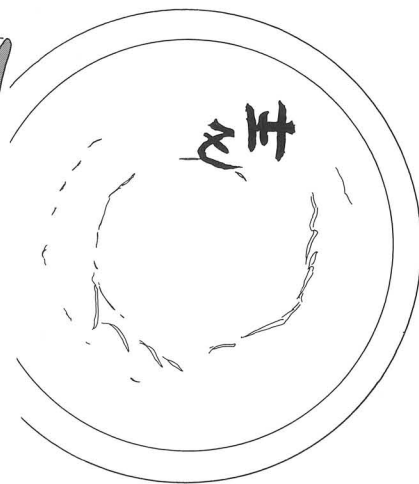
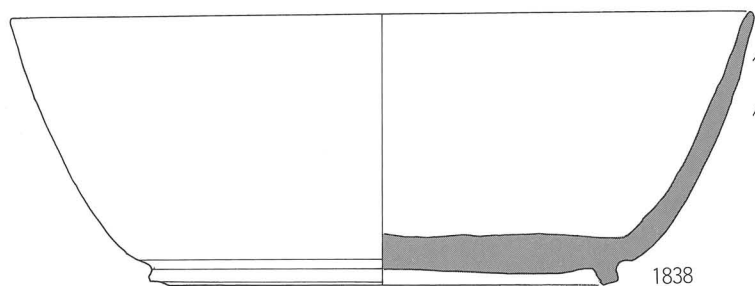
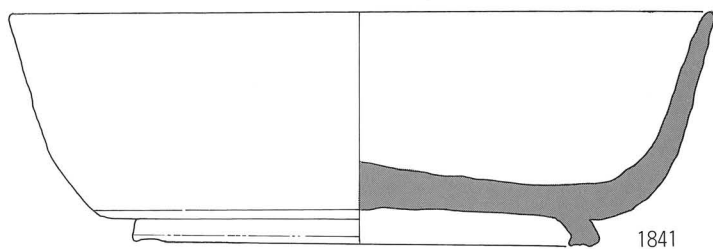
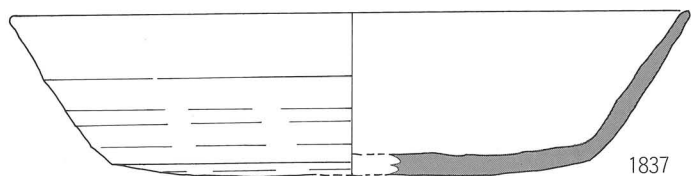
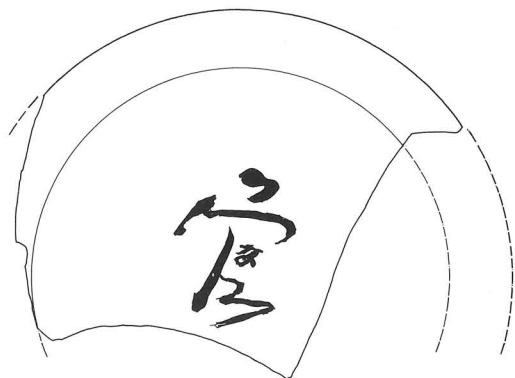
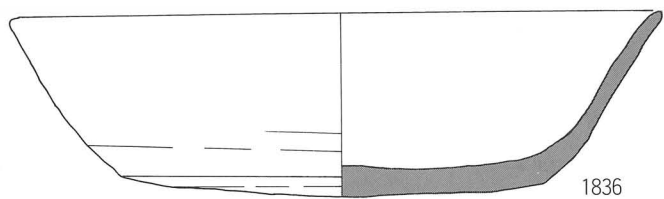
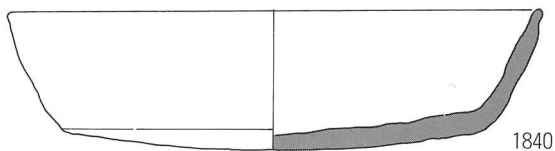
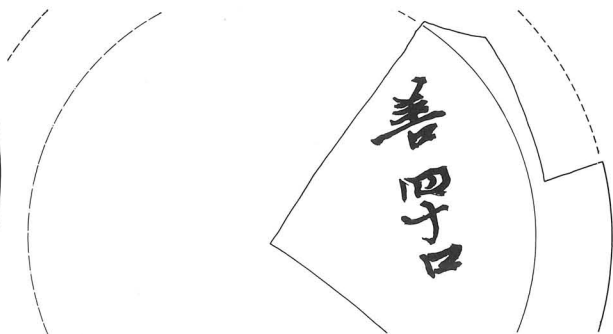
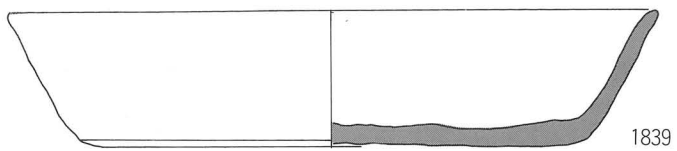
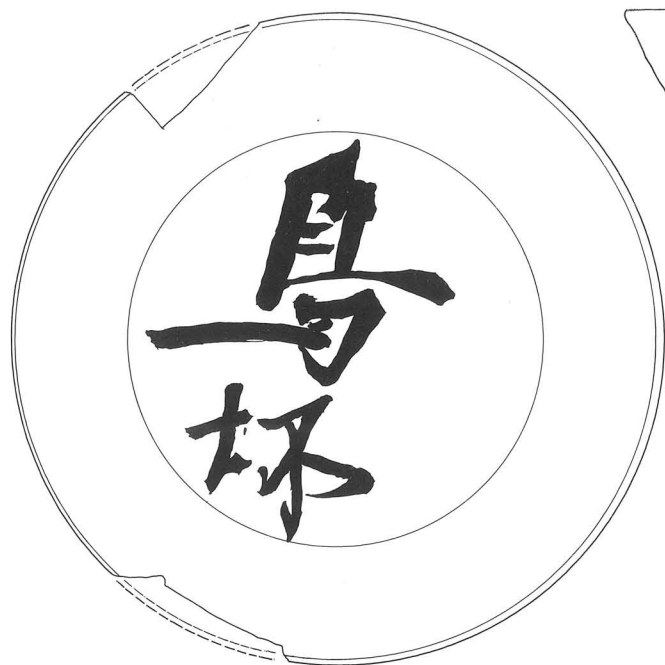

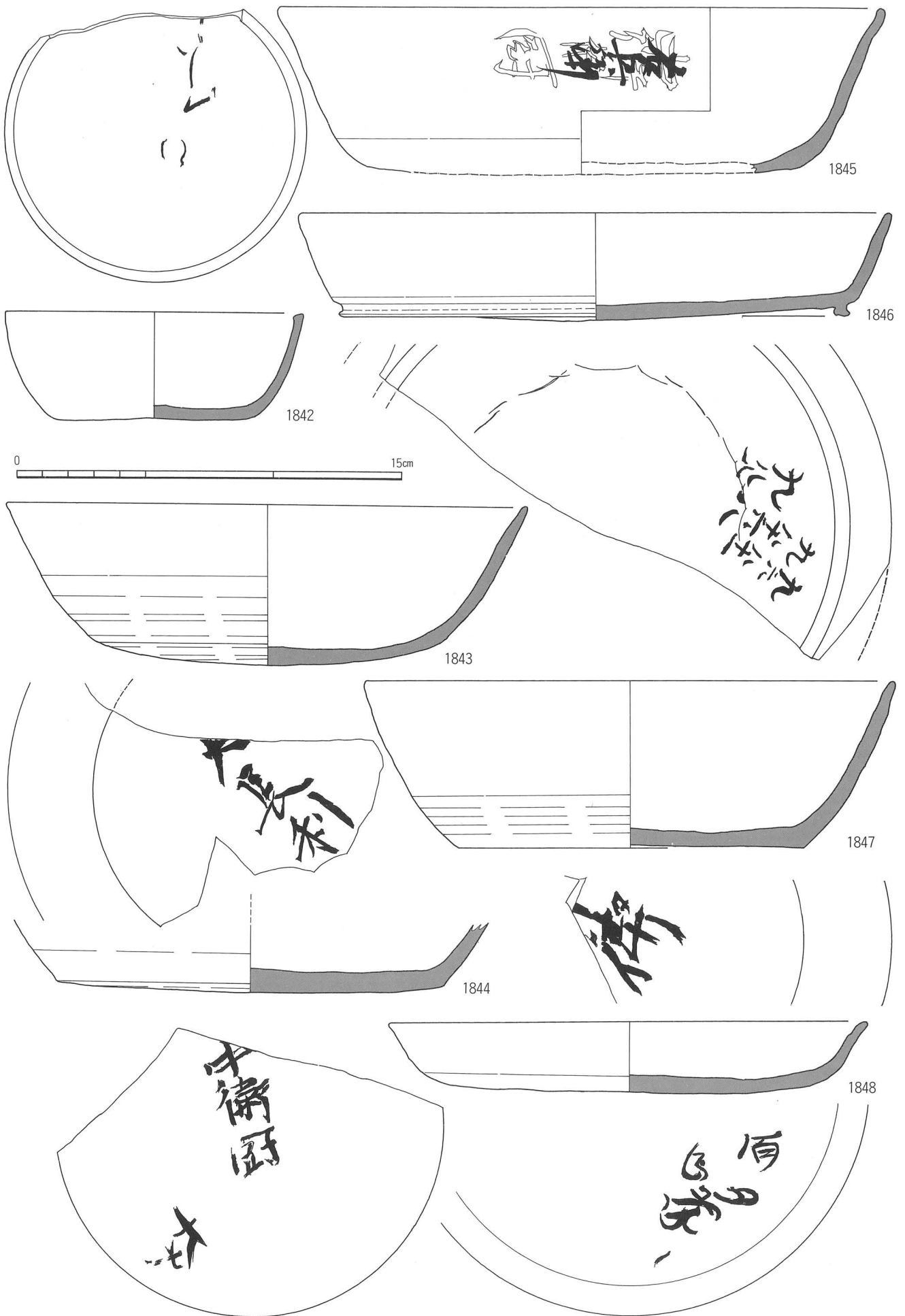

足下佐助百拜後 (背面)

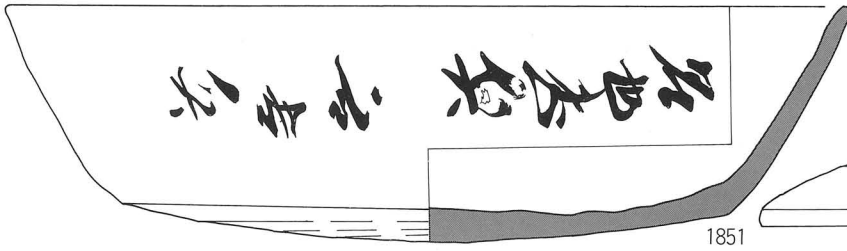

1851

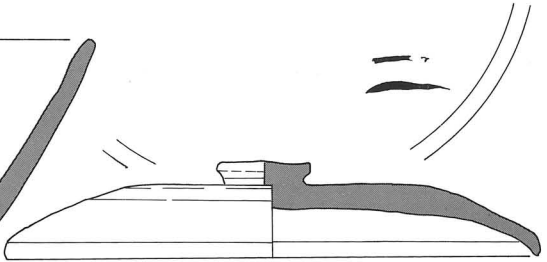

1849

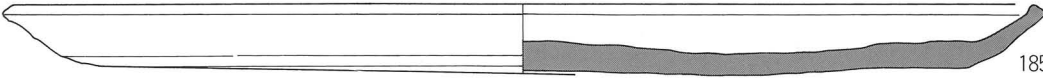

1854

下

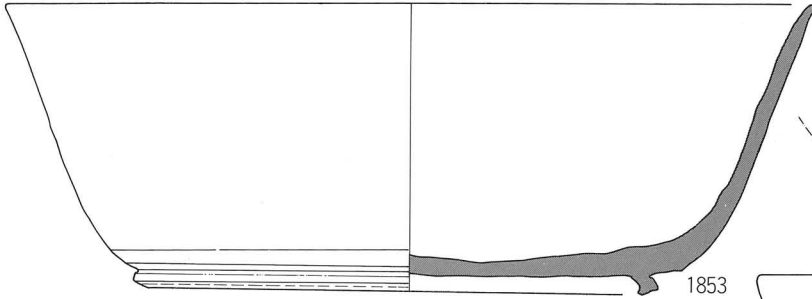
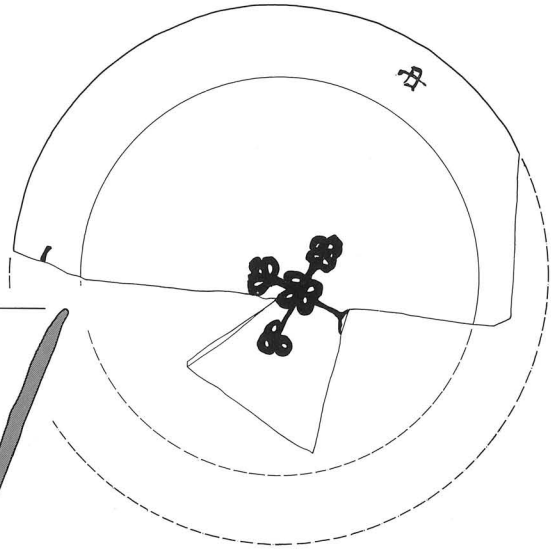

1853

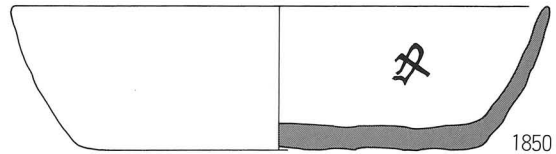

1850

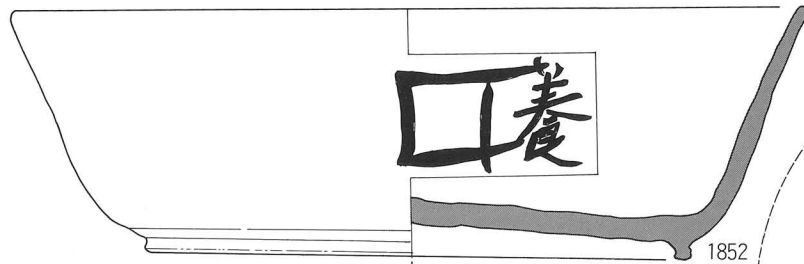

1852

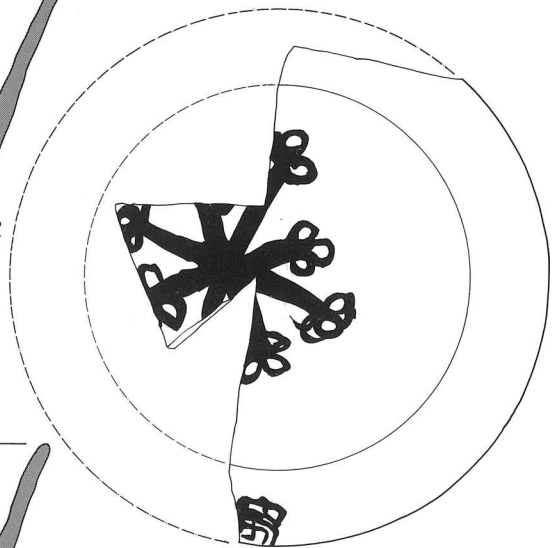

下

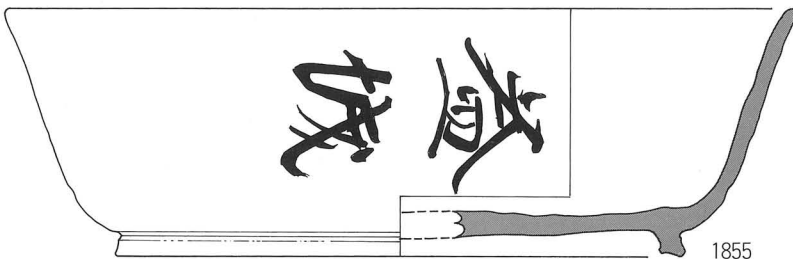

1855

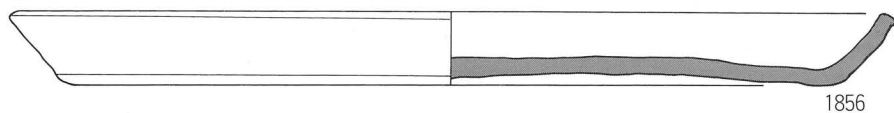

1856

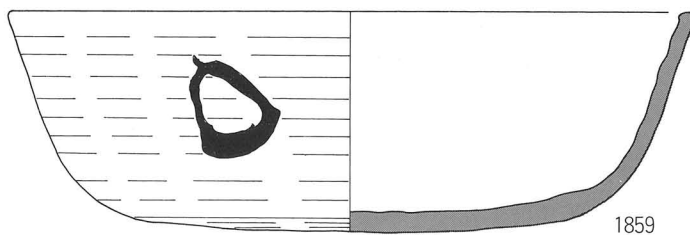

1859

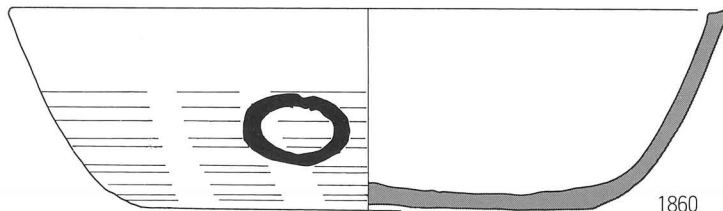

1860

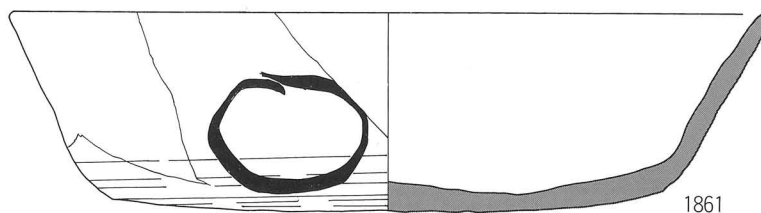

1861

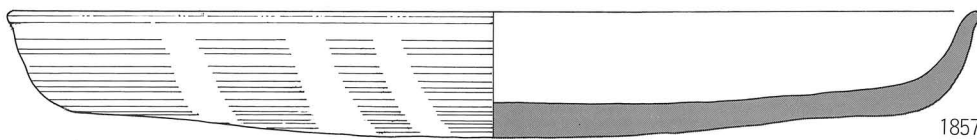

1857

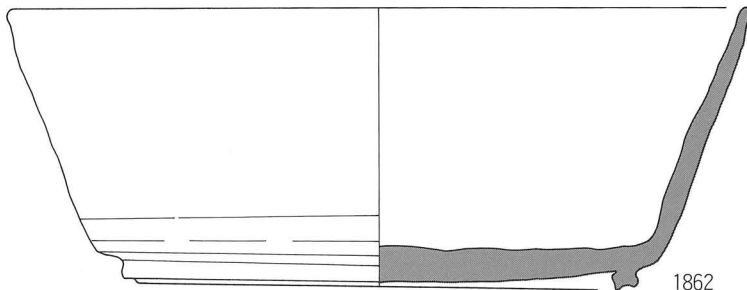
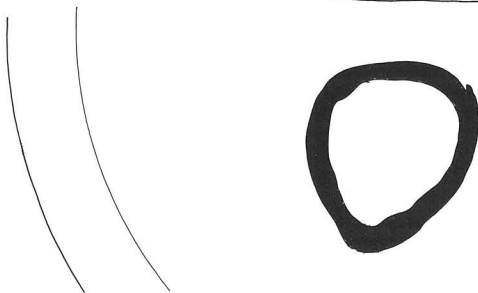

1862

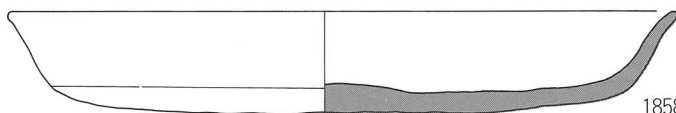

1858

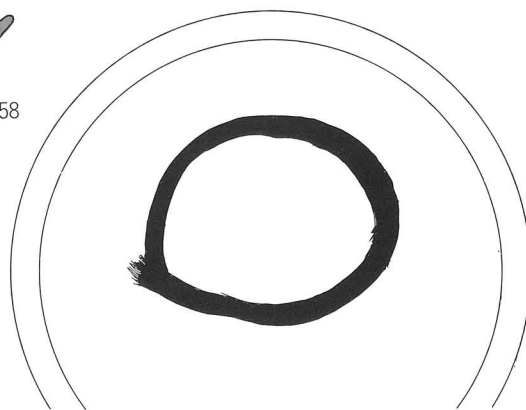

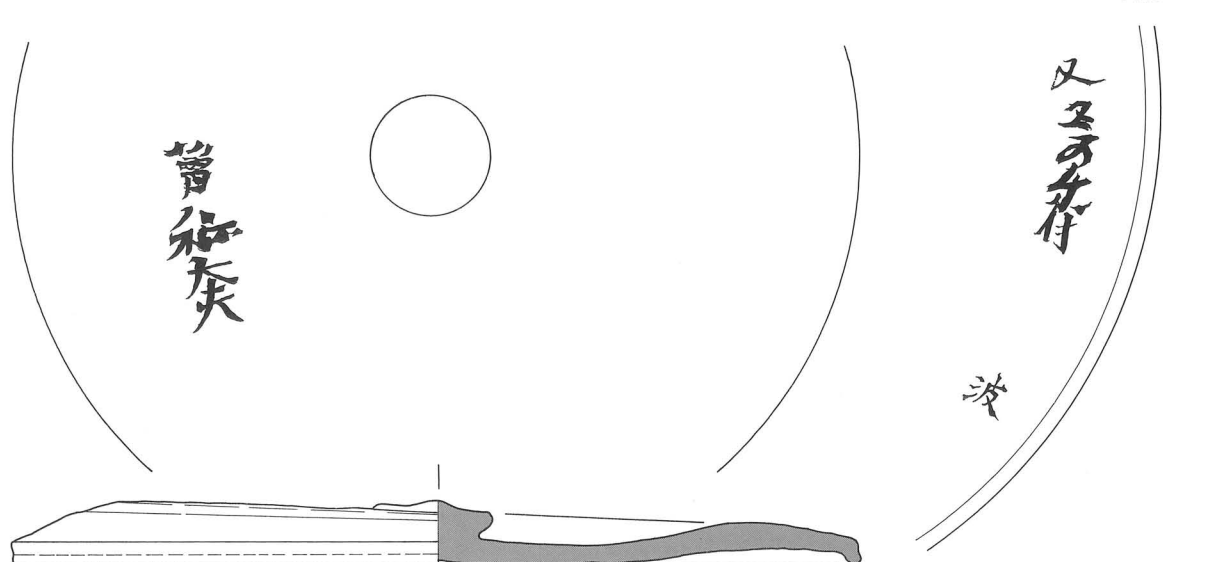
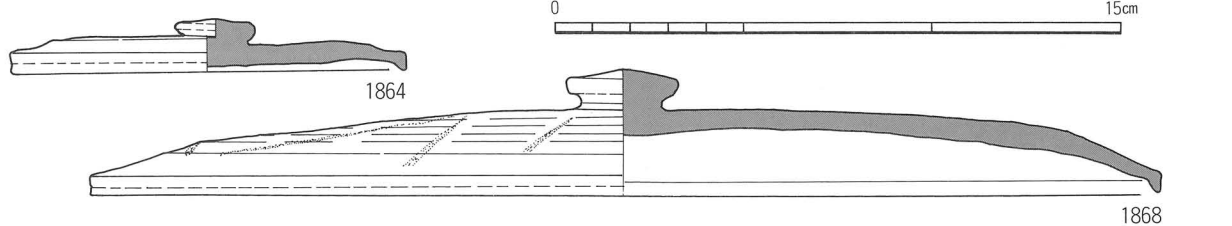
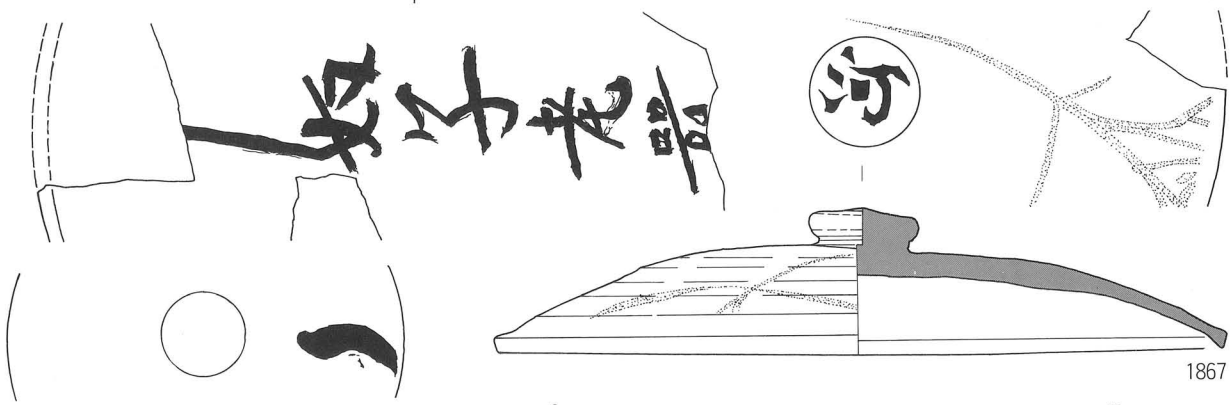
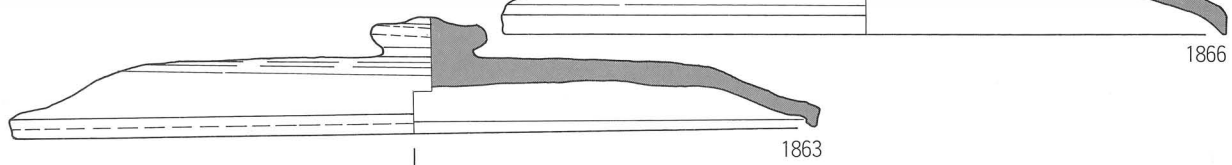
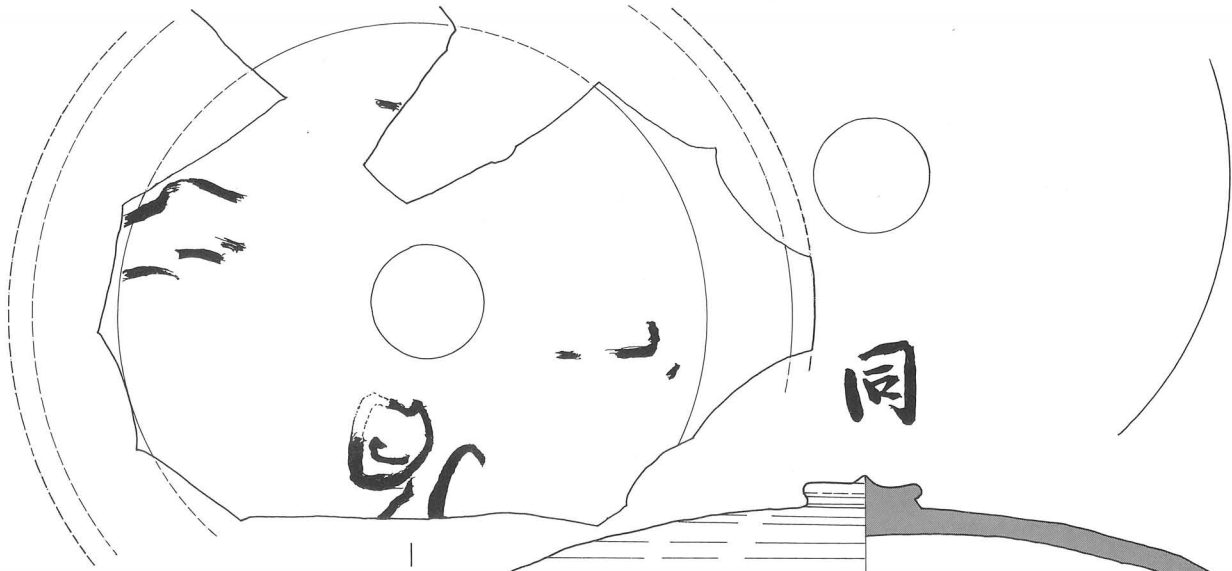

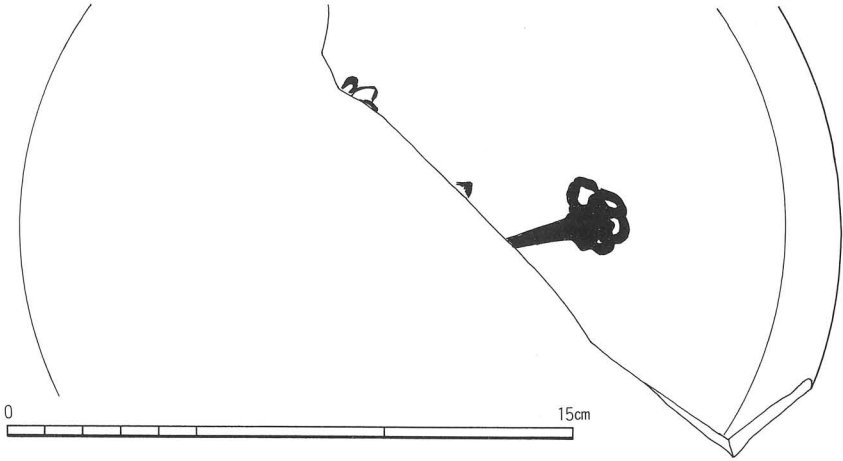
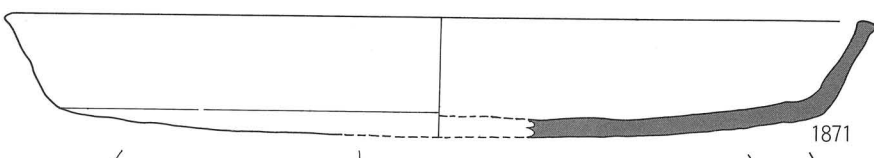
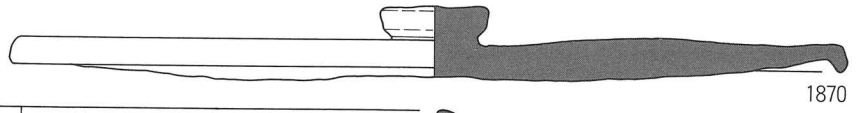
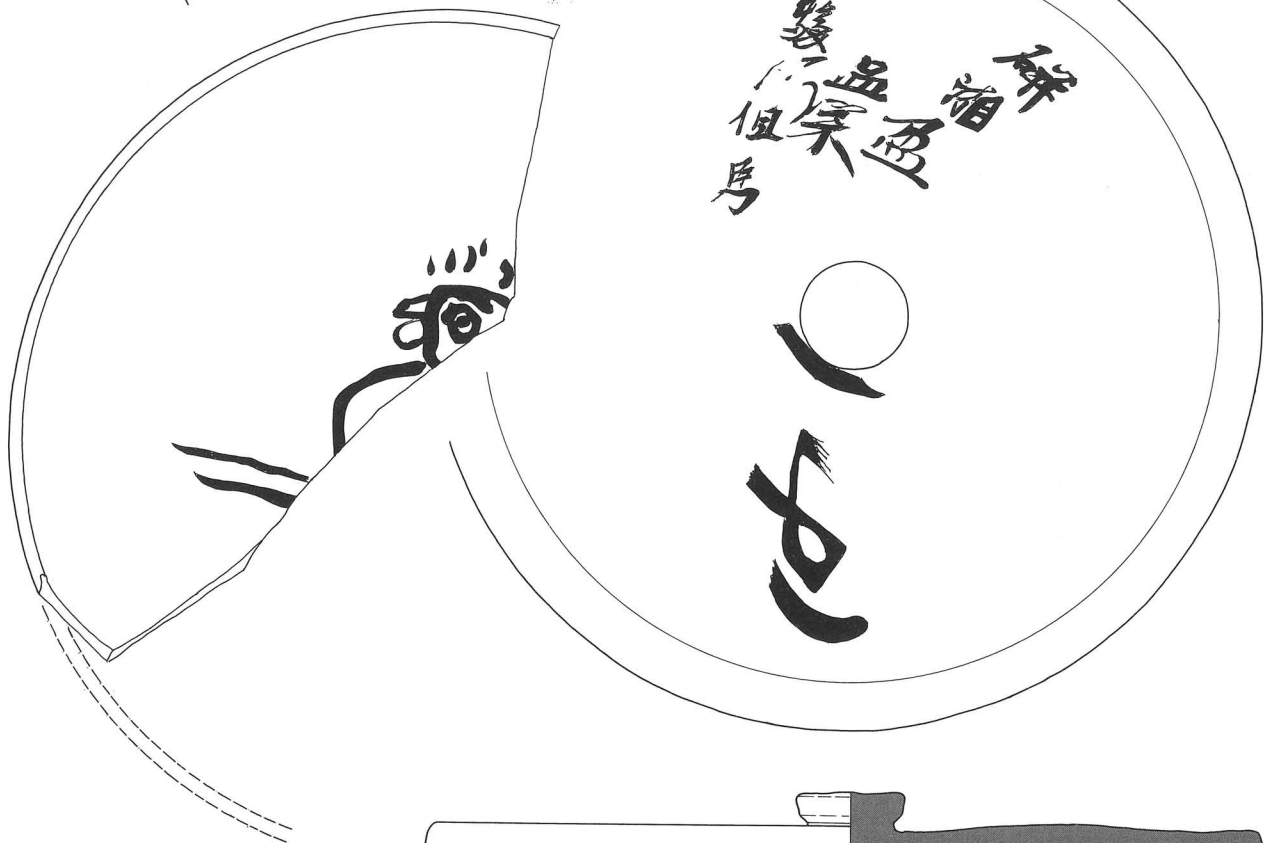
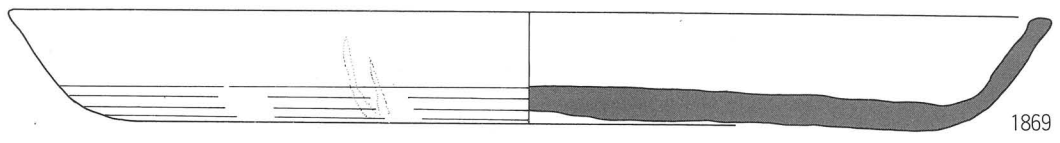

盤

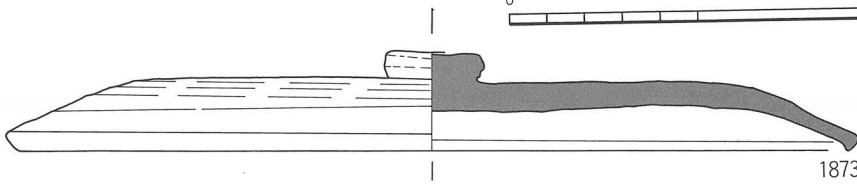
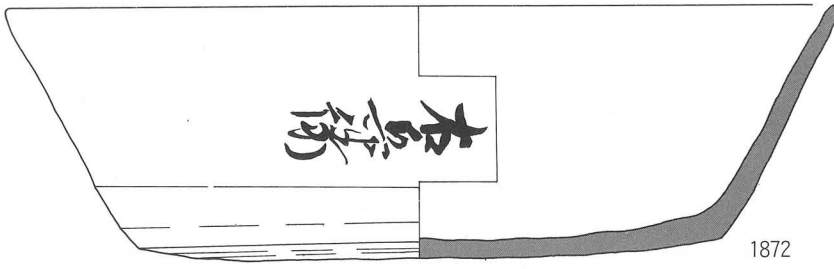

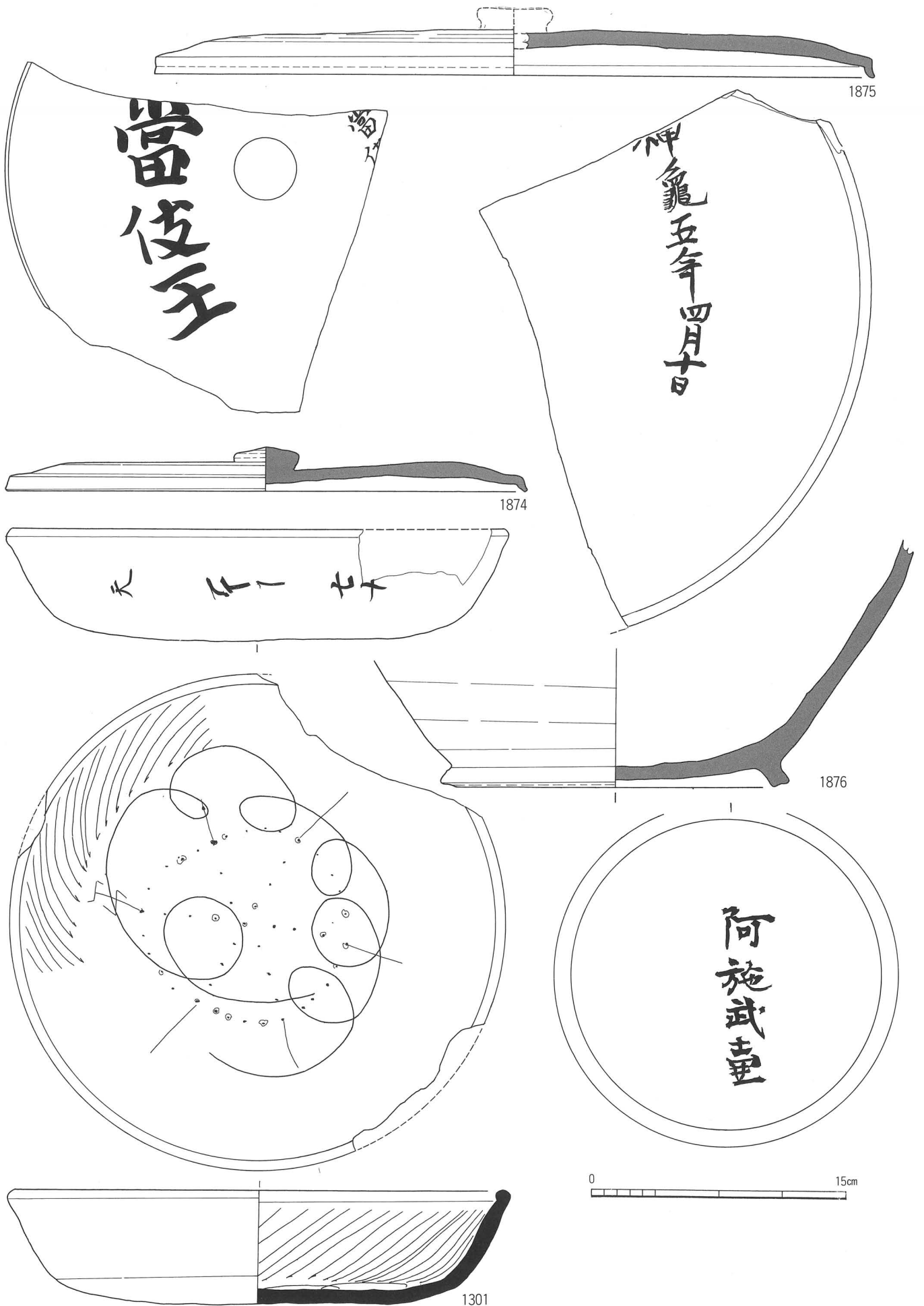

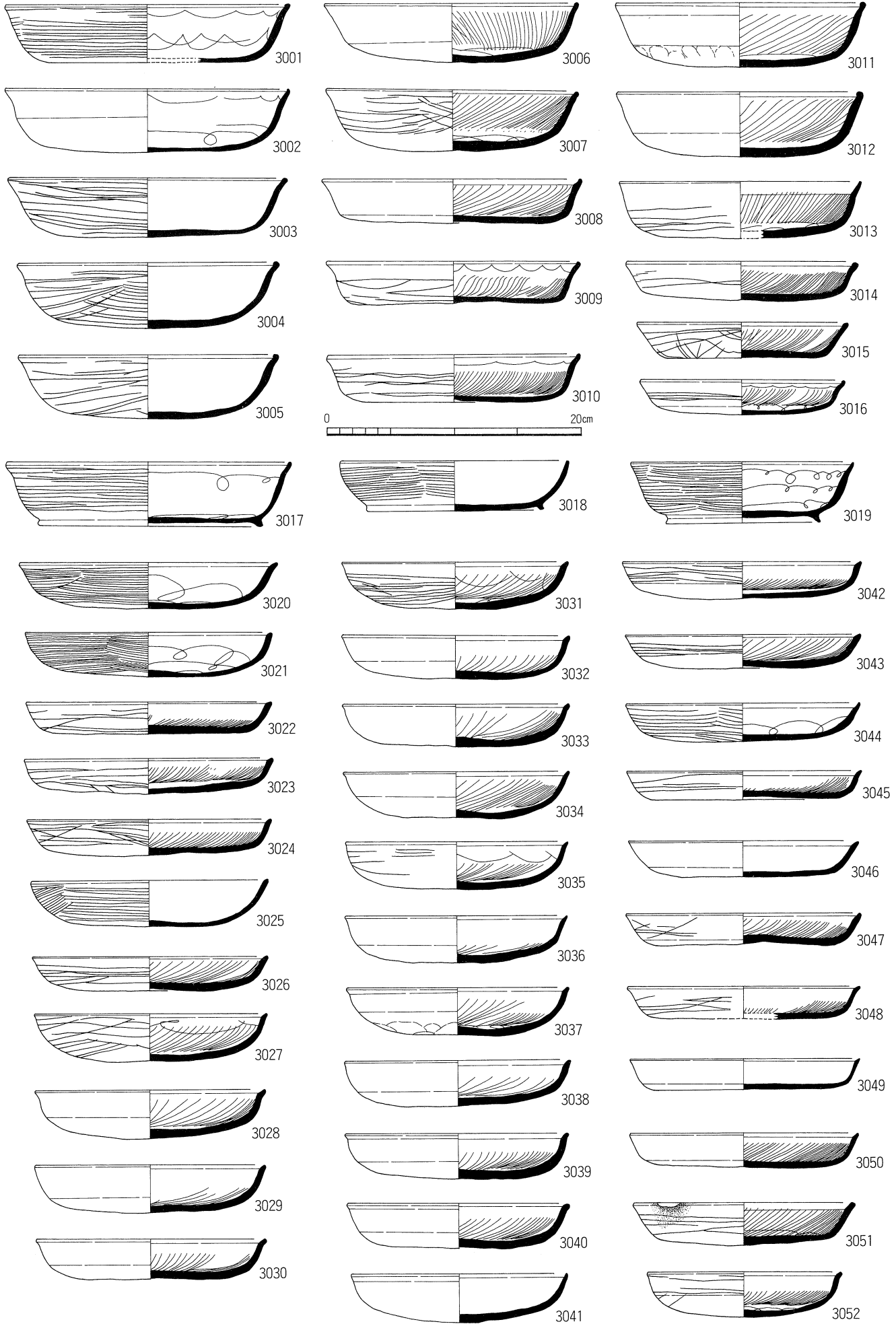

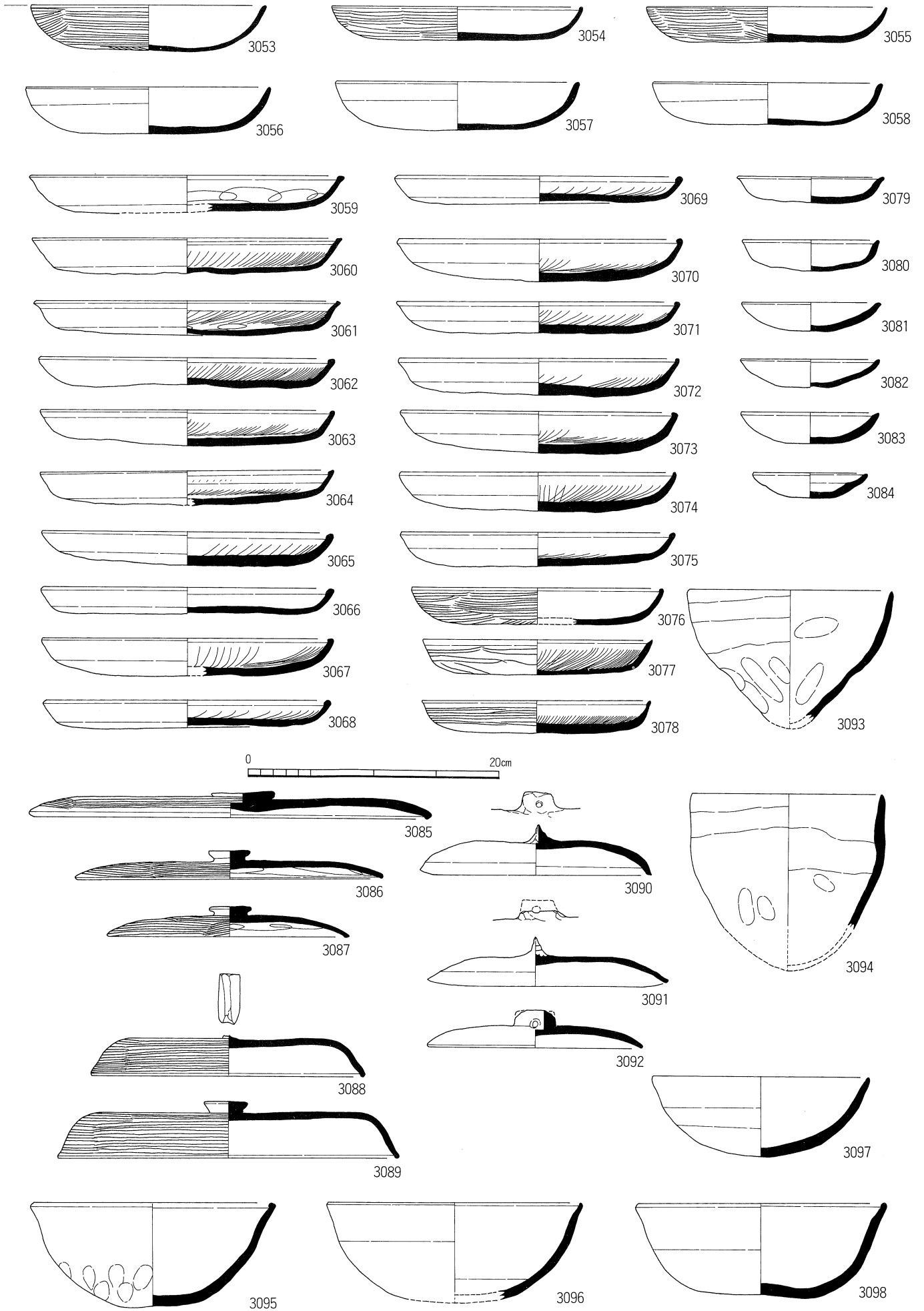

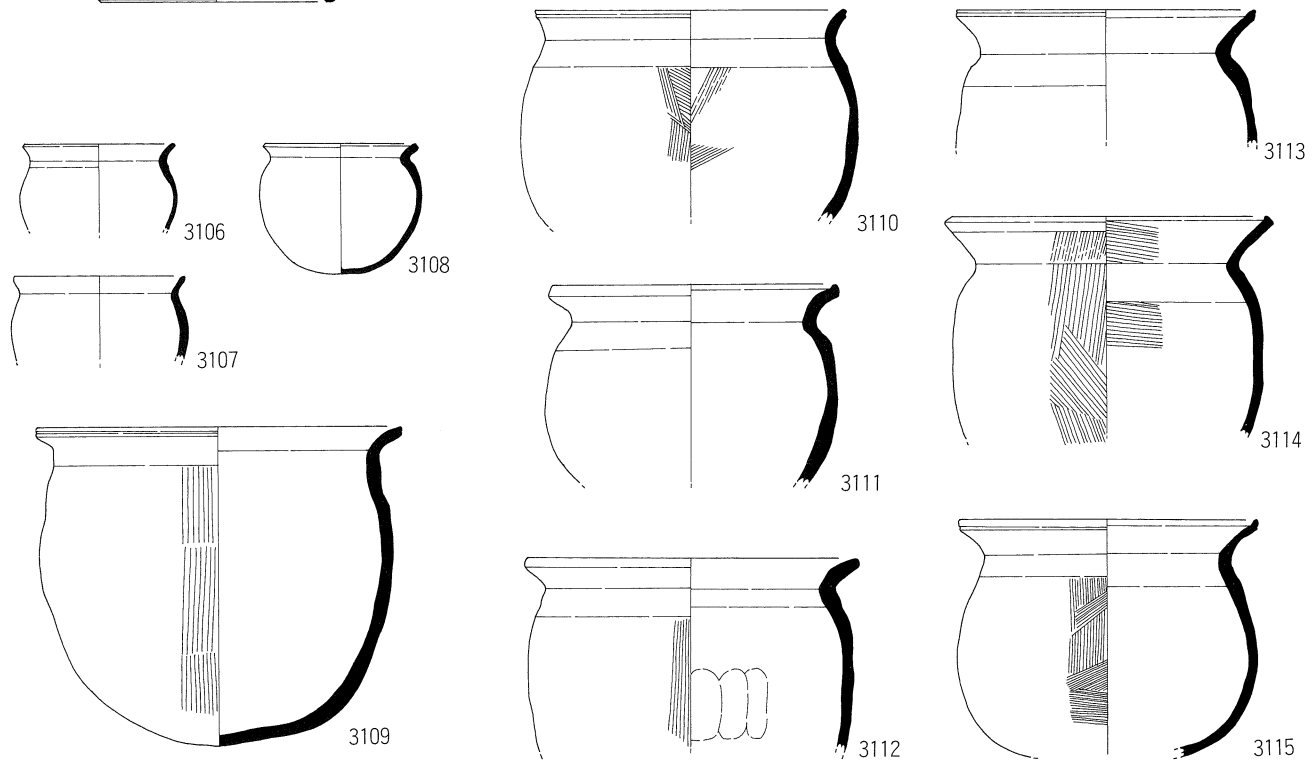
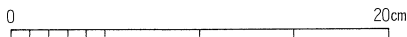
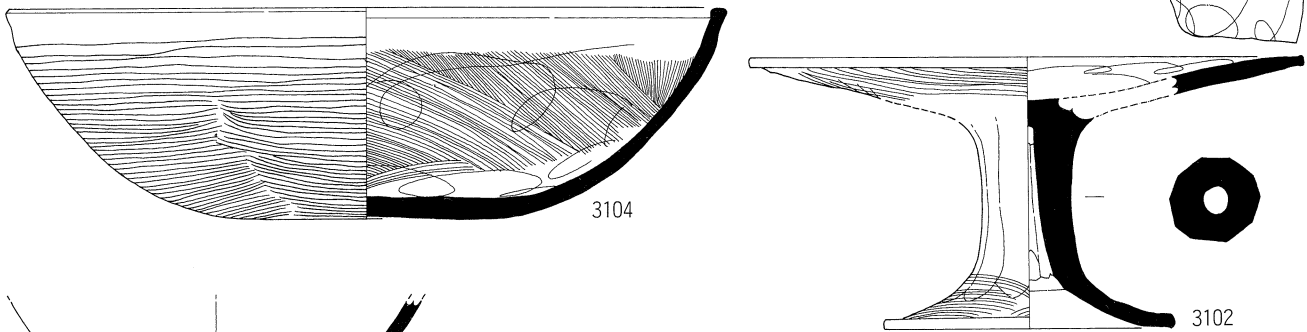
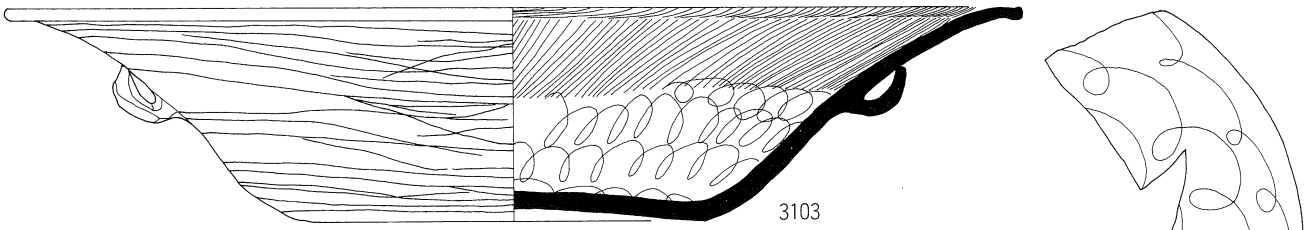
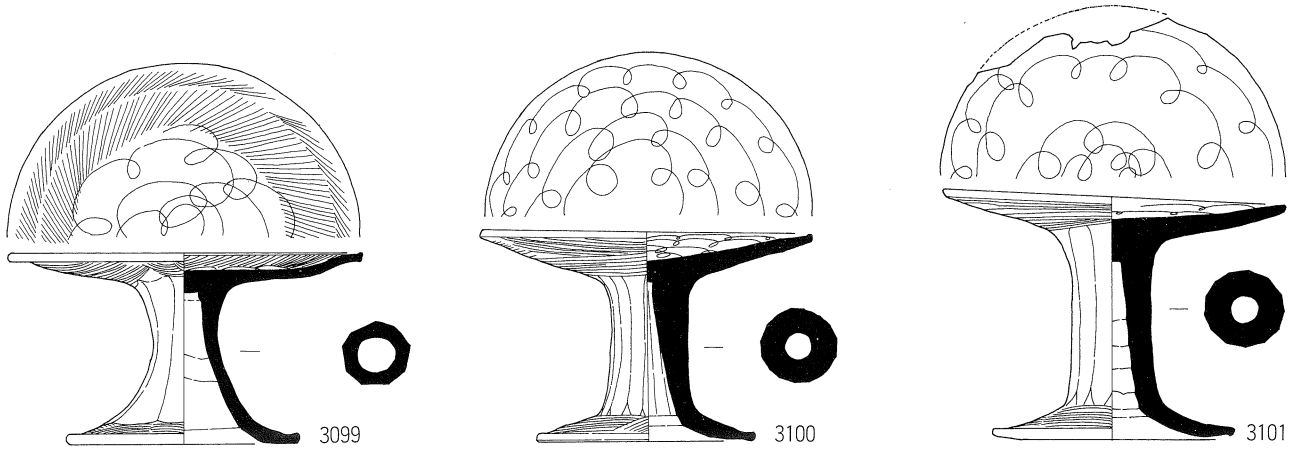

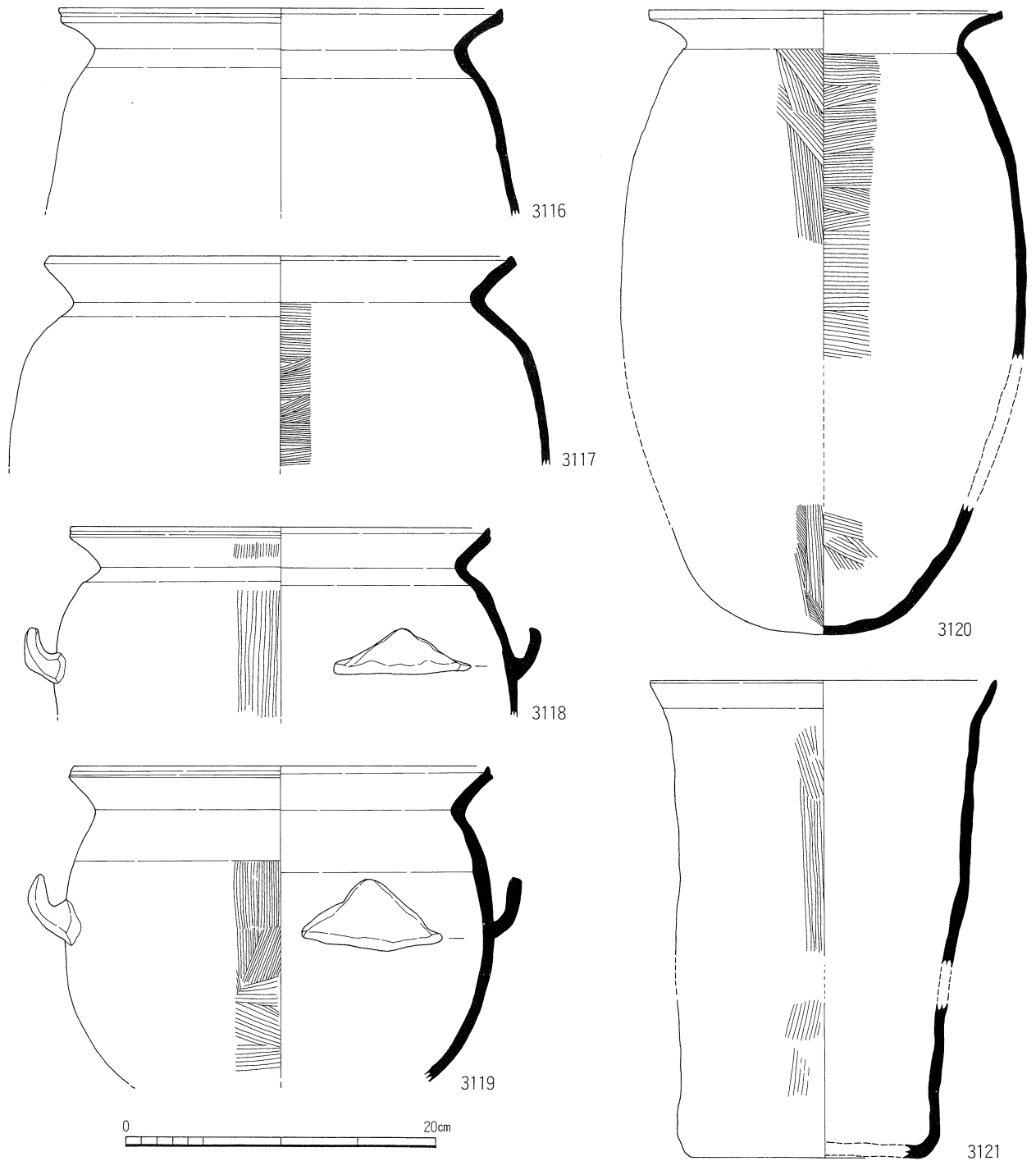

1 : 4

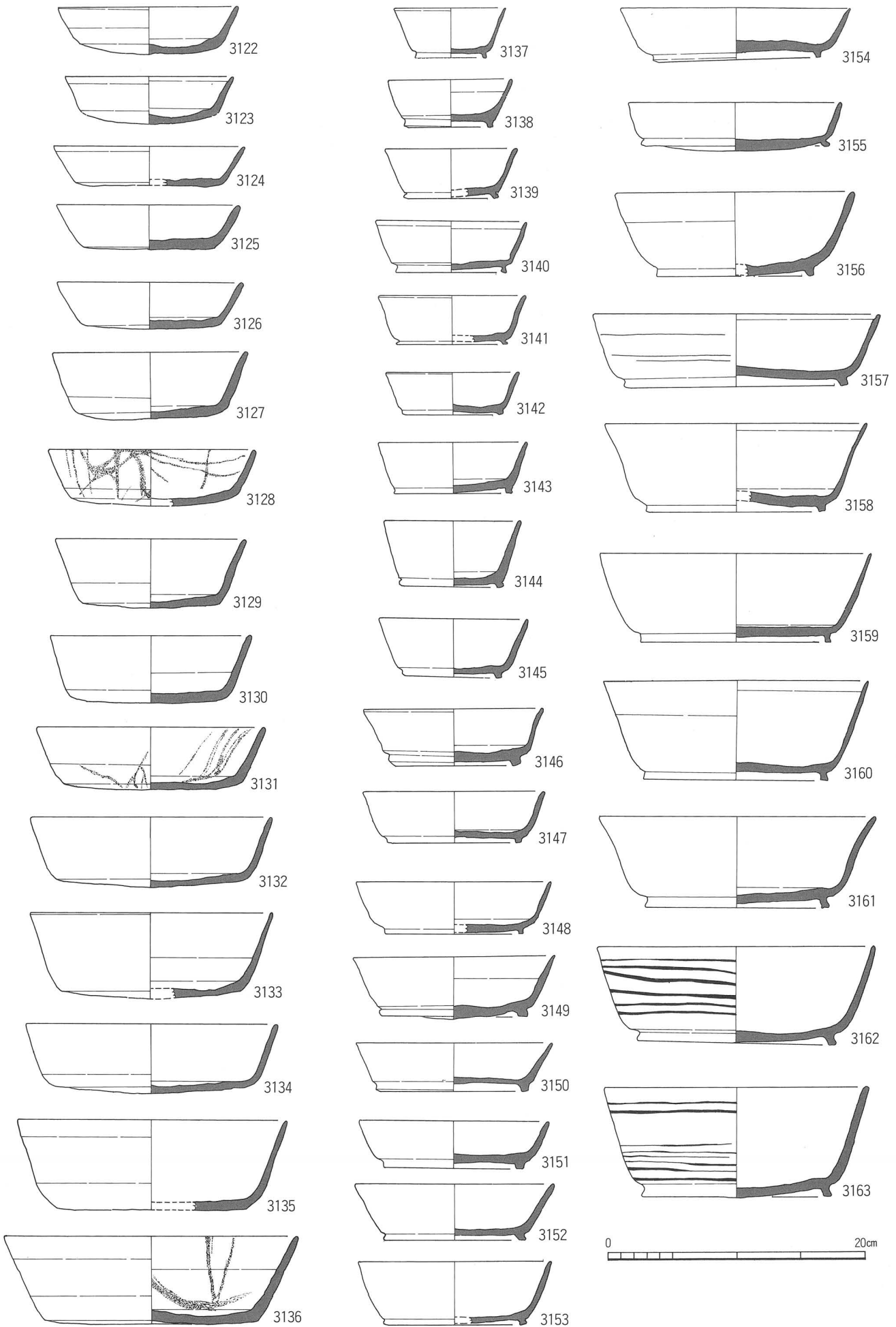

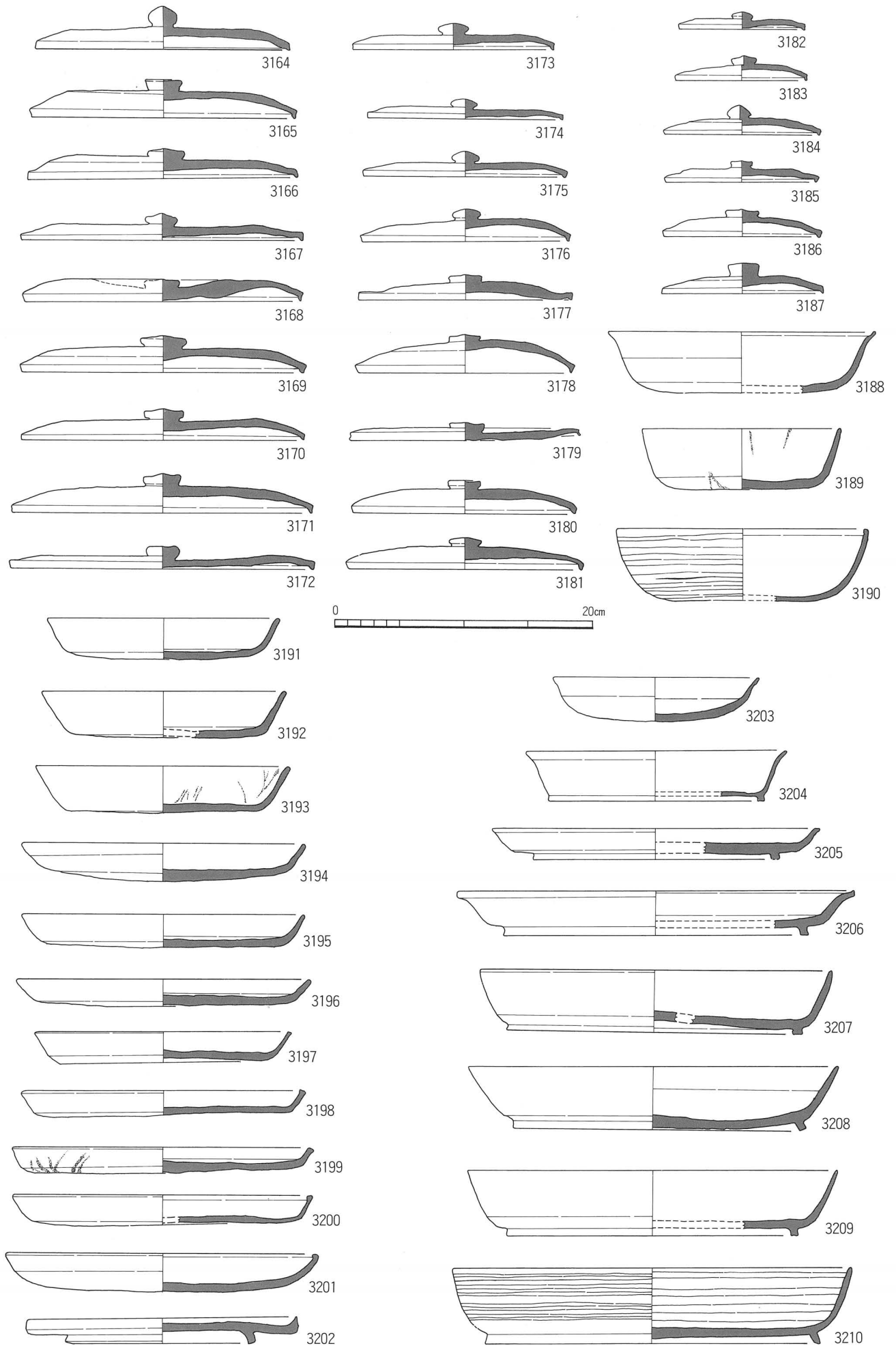

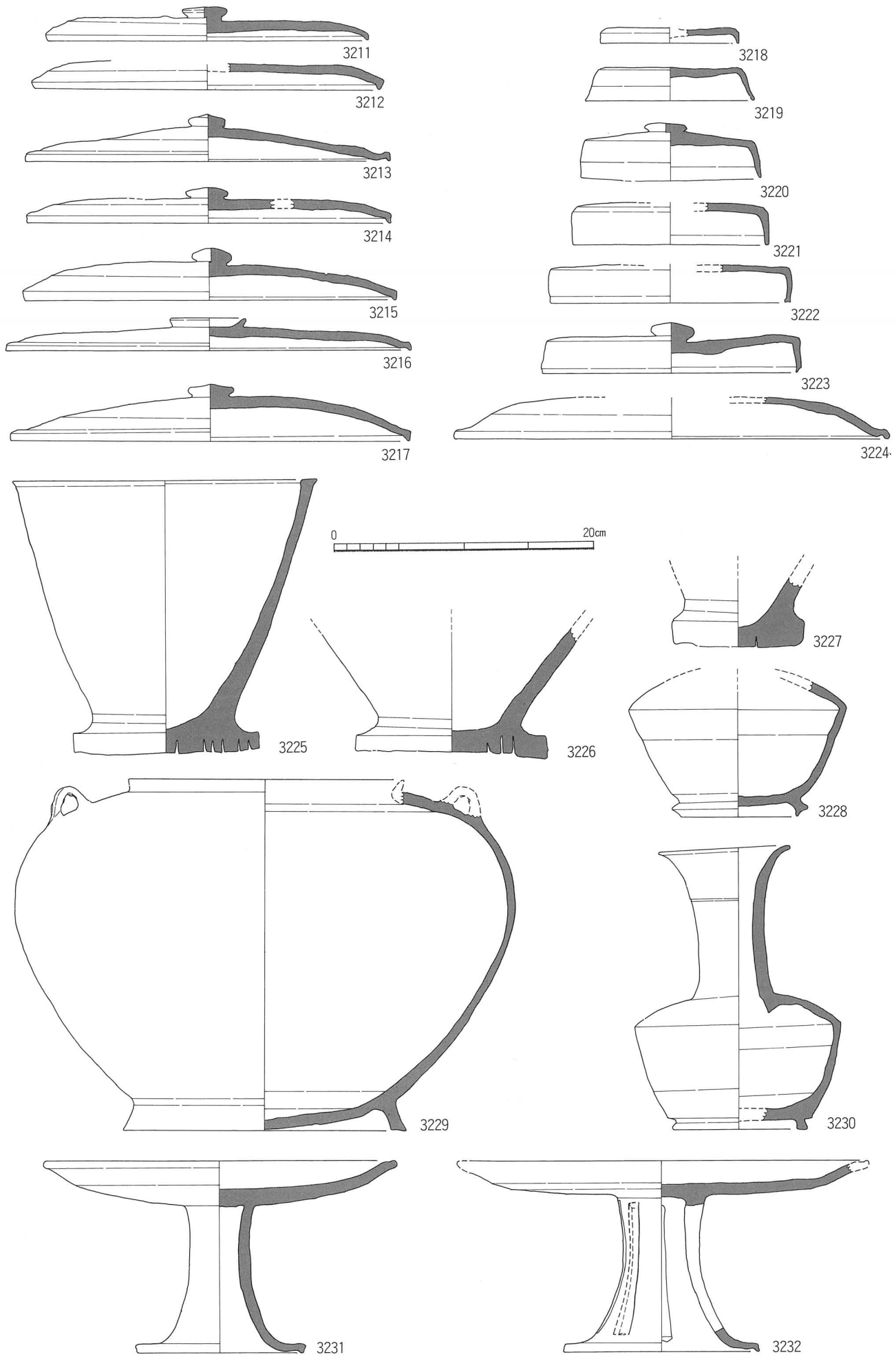

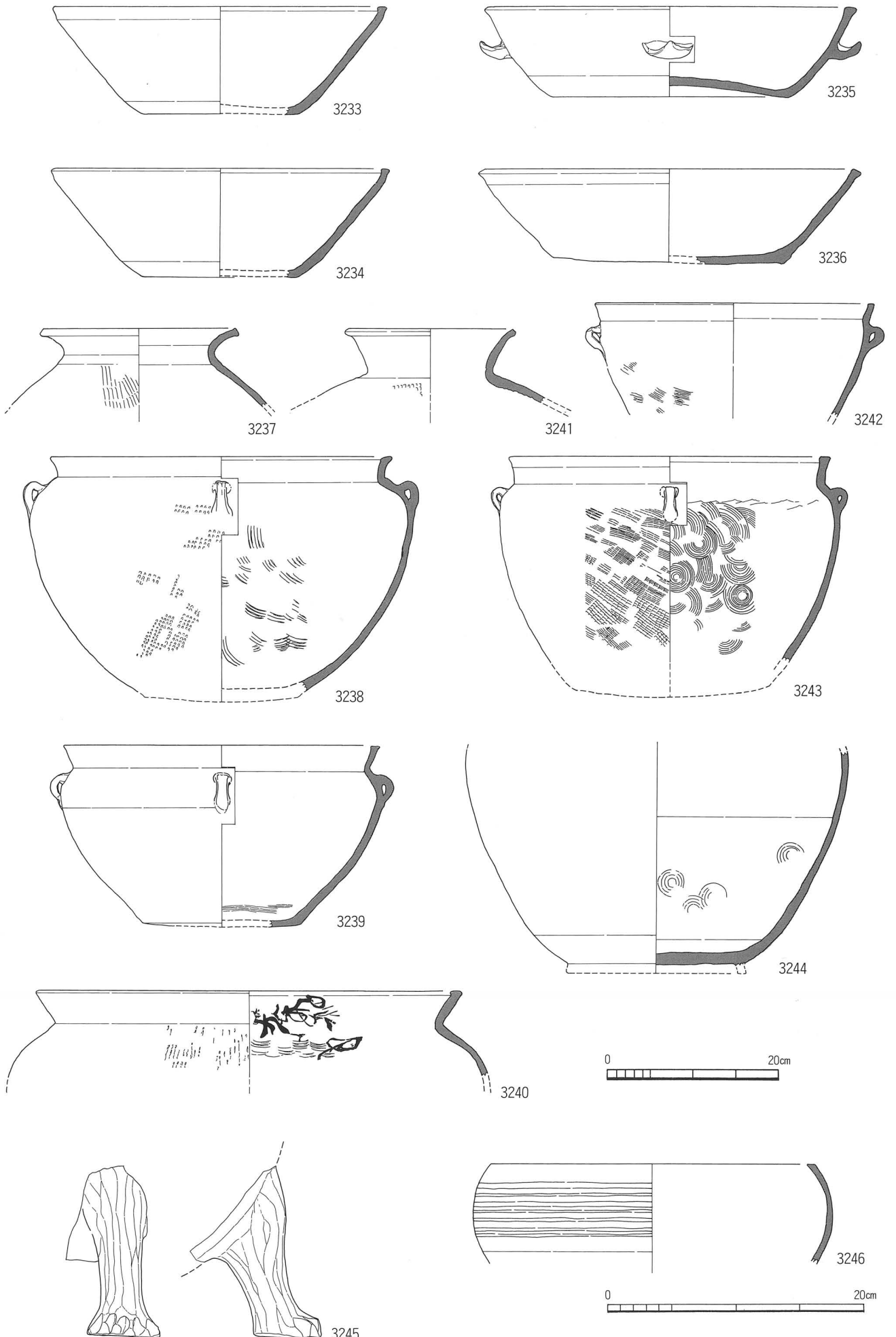

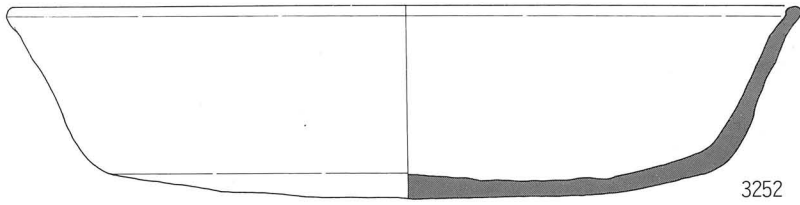

3252

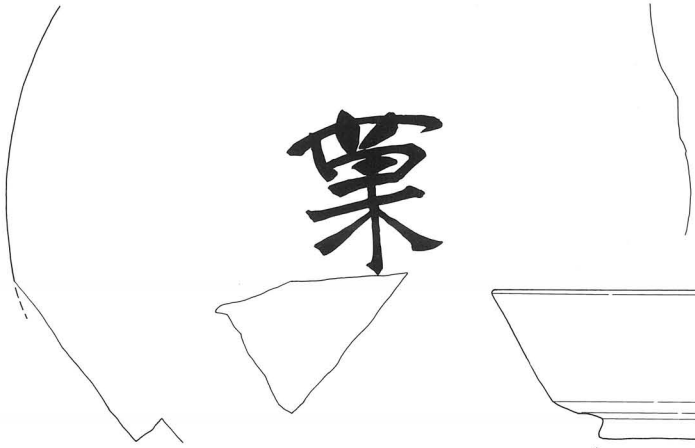

菓

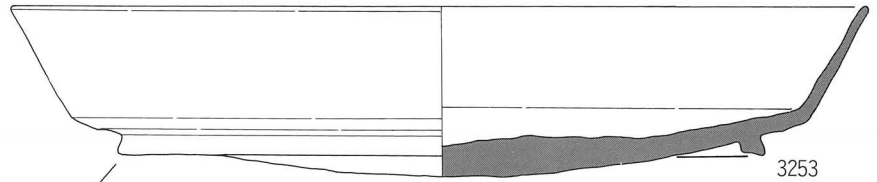

3253



菓

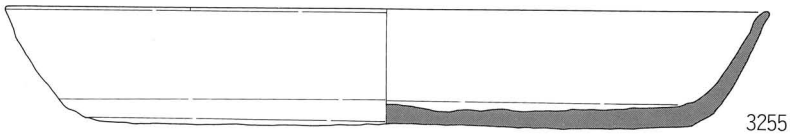

3255



兵

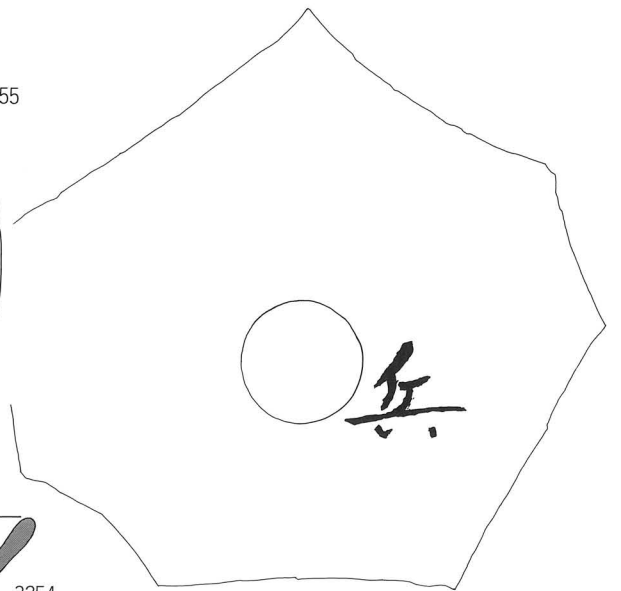

兵

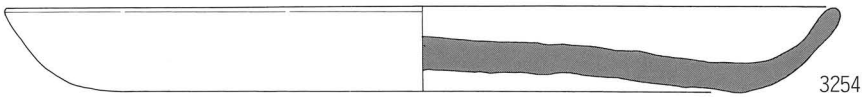

3254



師
師

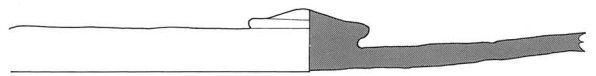

3256



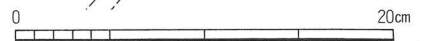
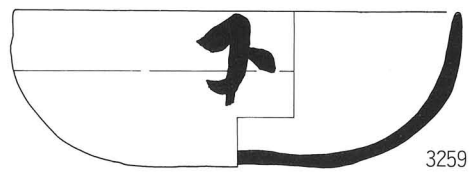
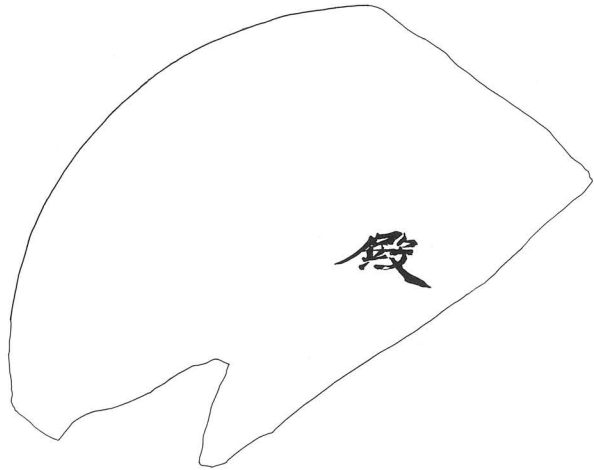
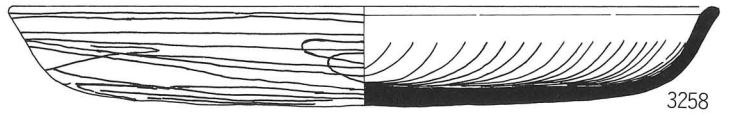
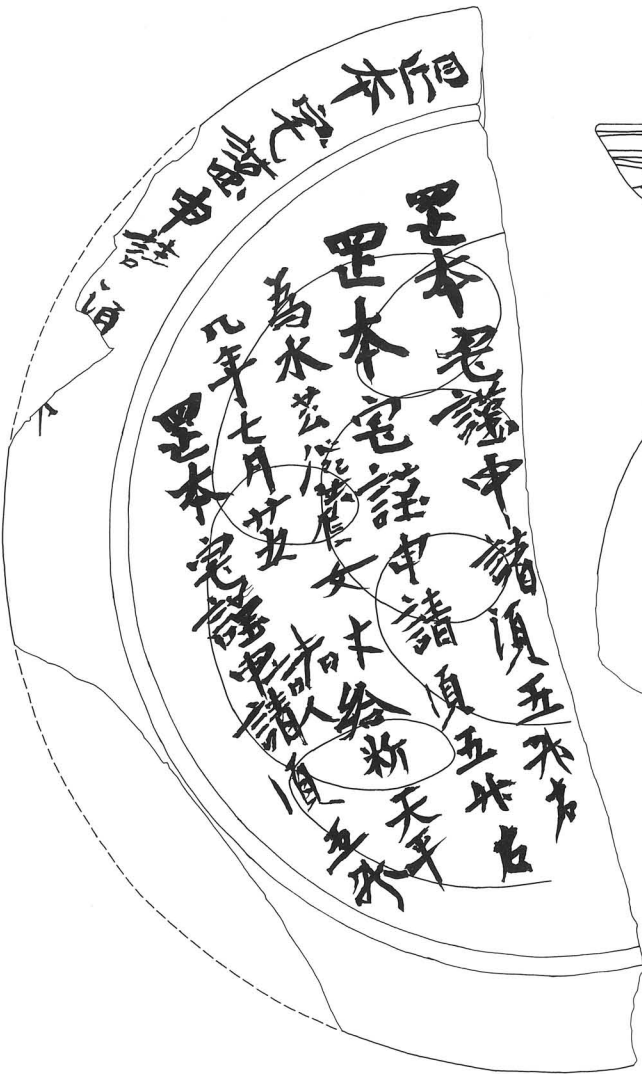
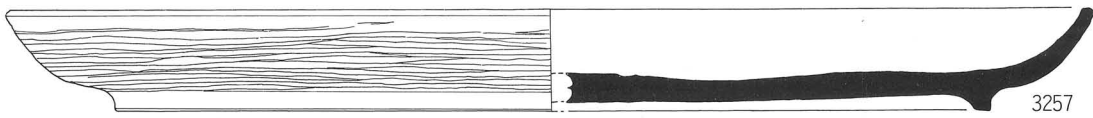

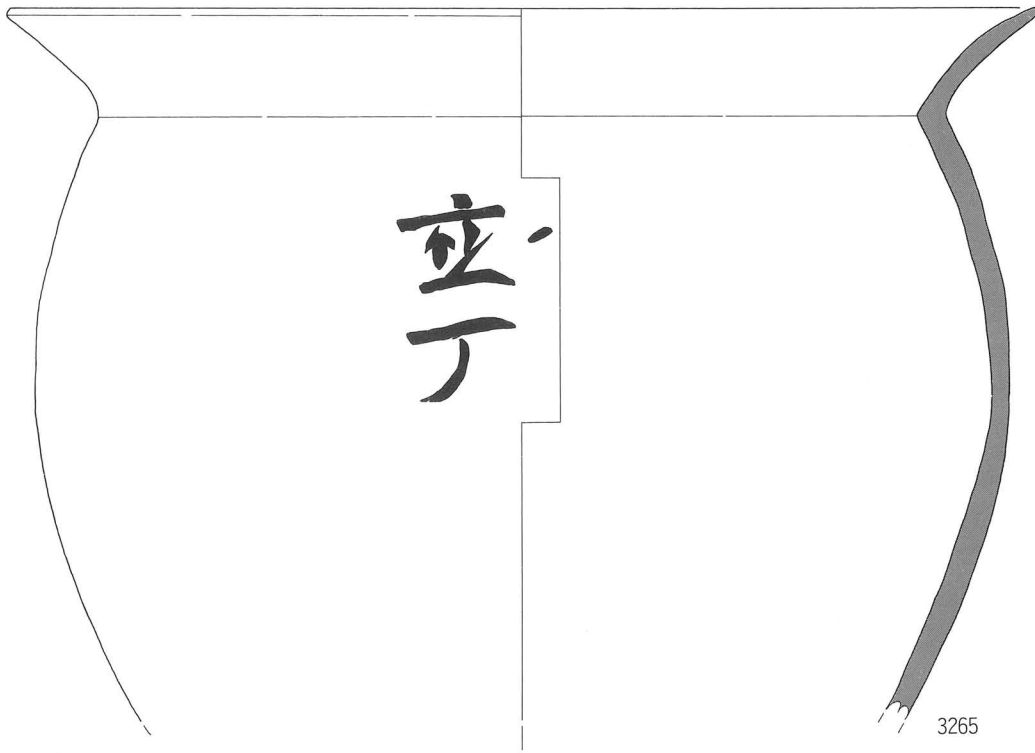
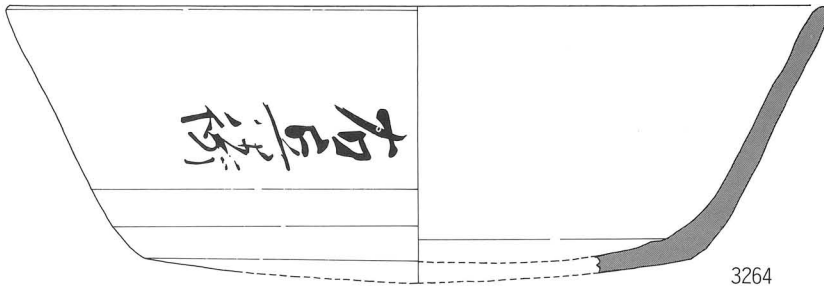
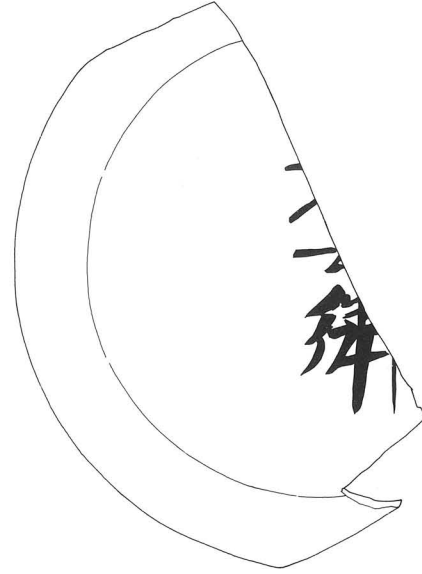
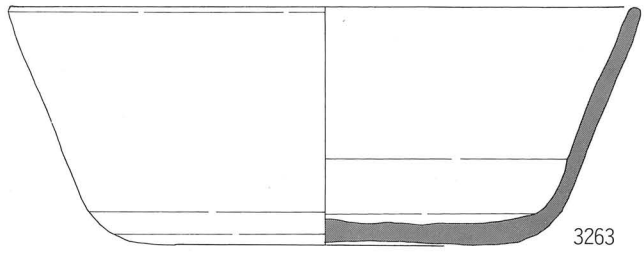
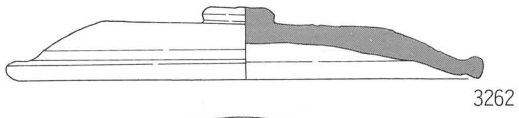

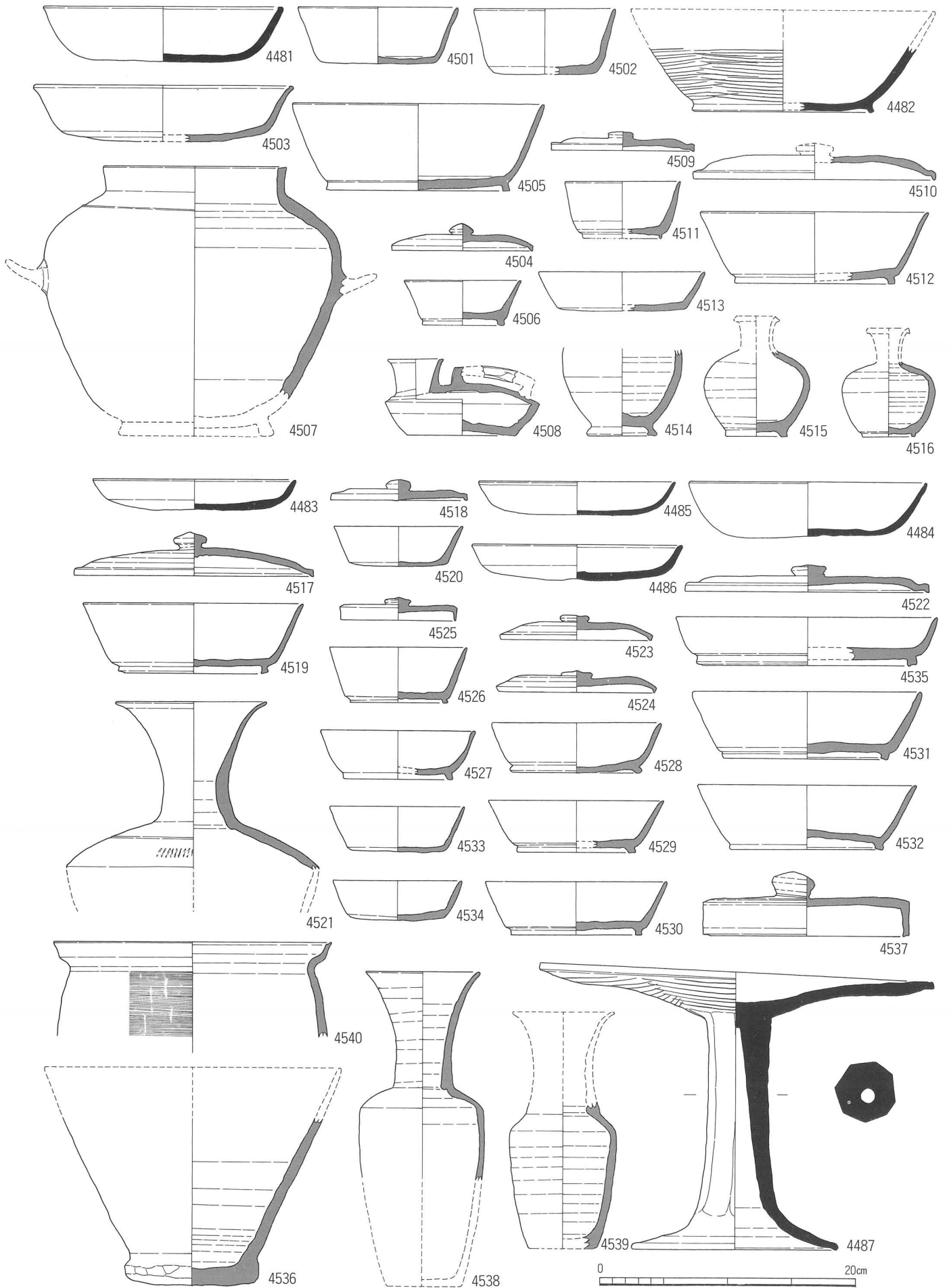

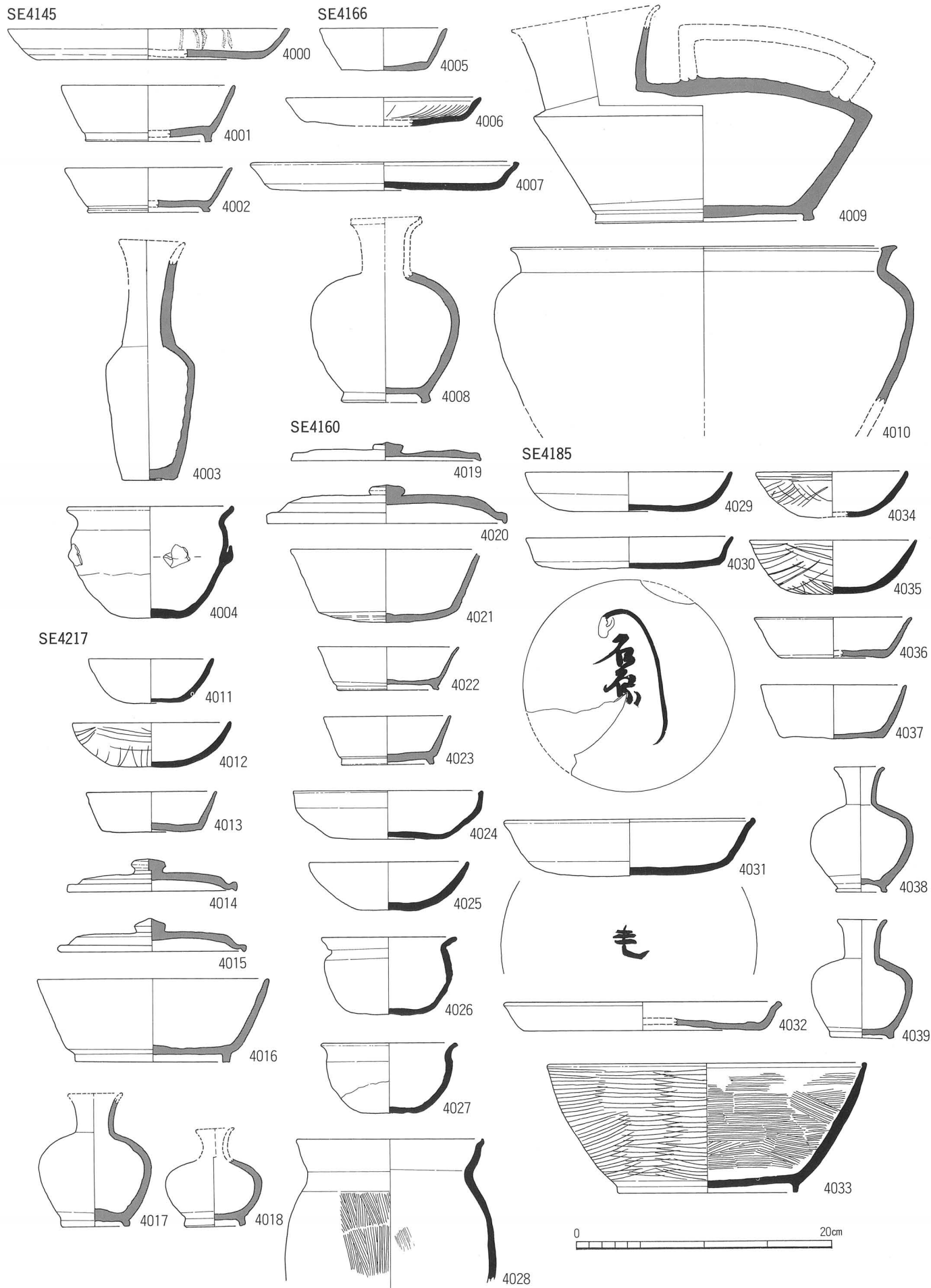

SE4268

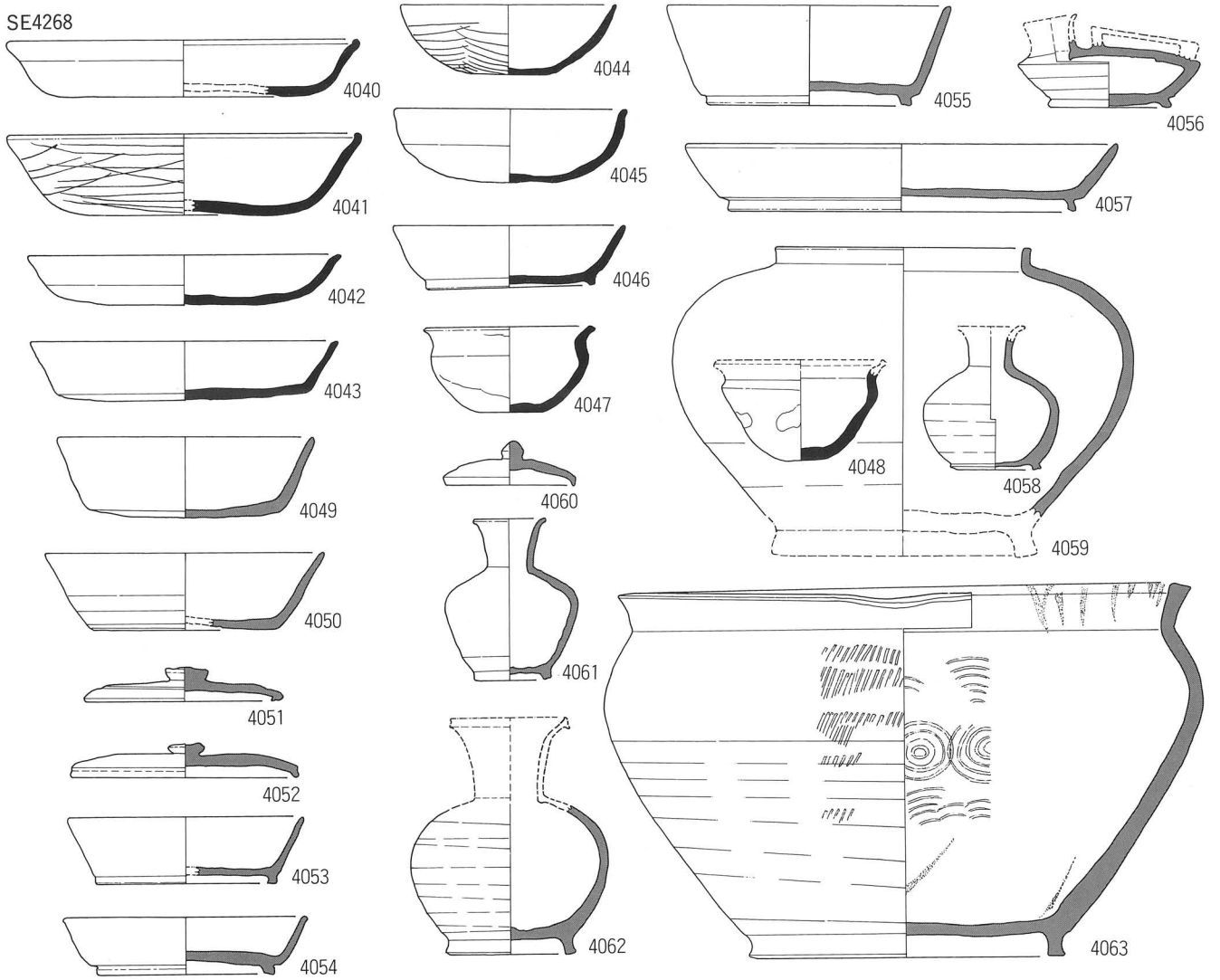

SE4365

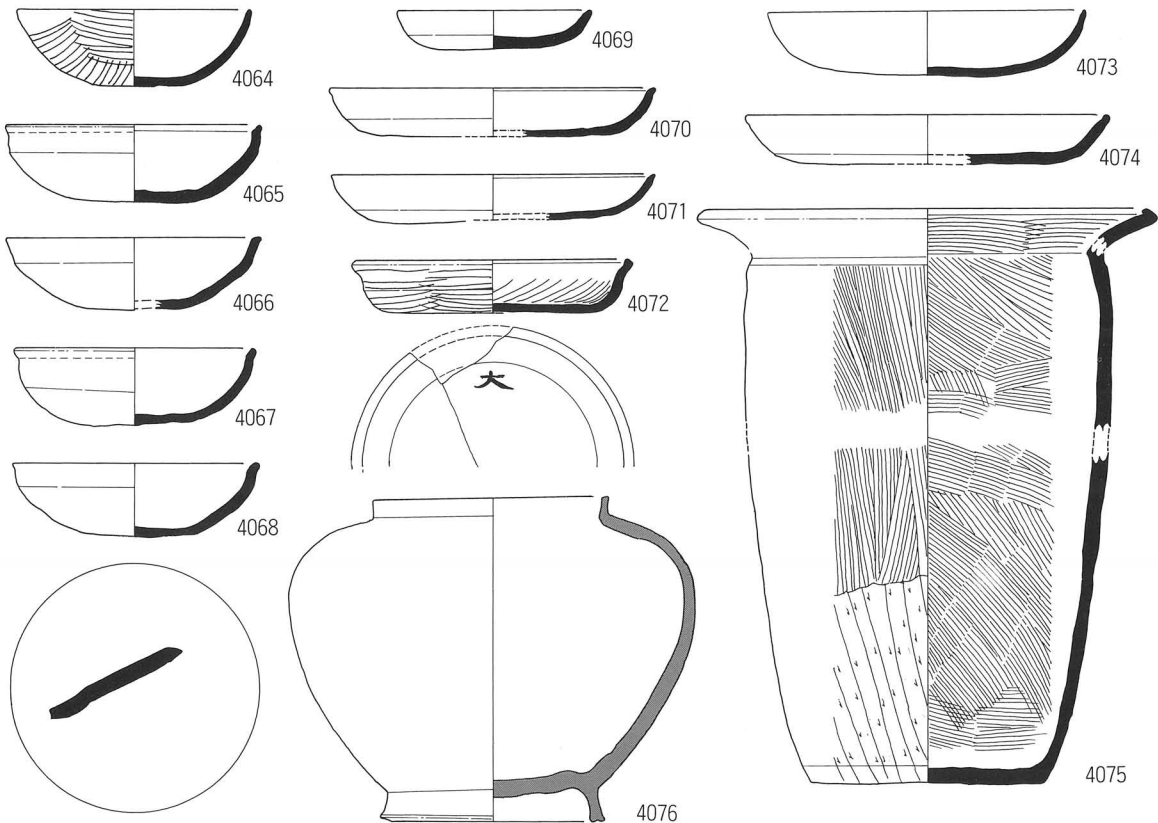

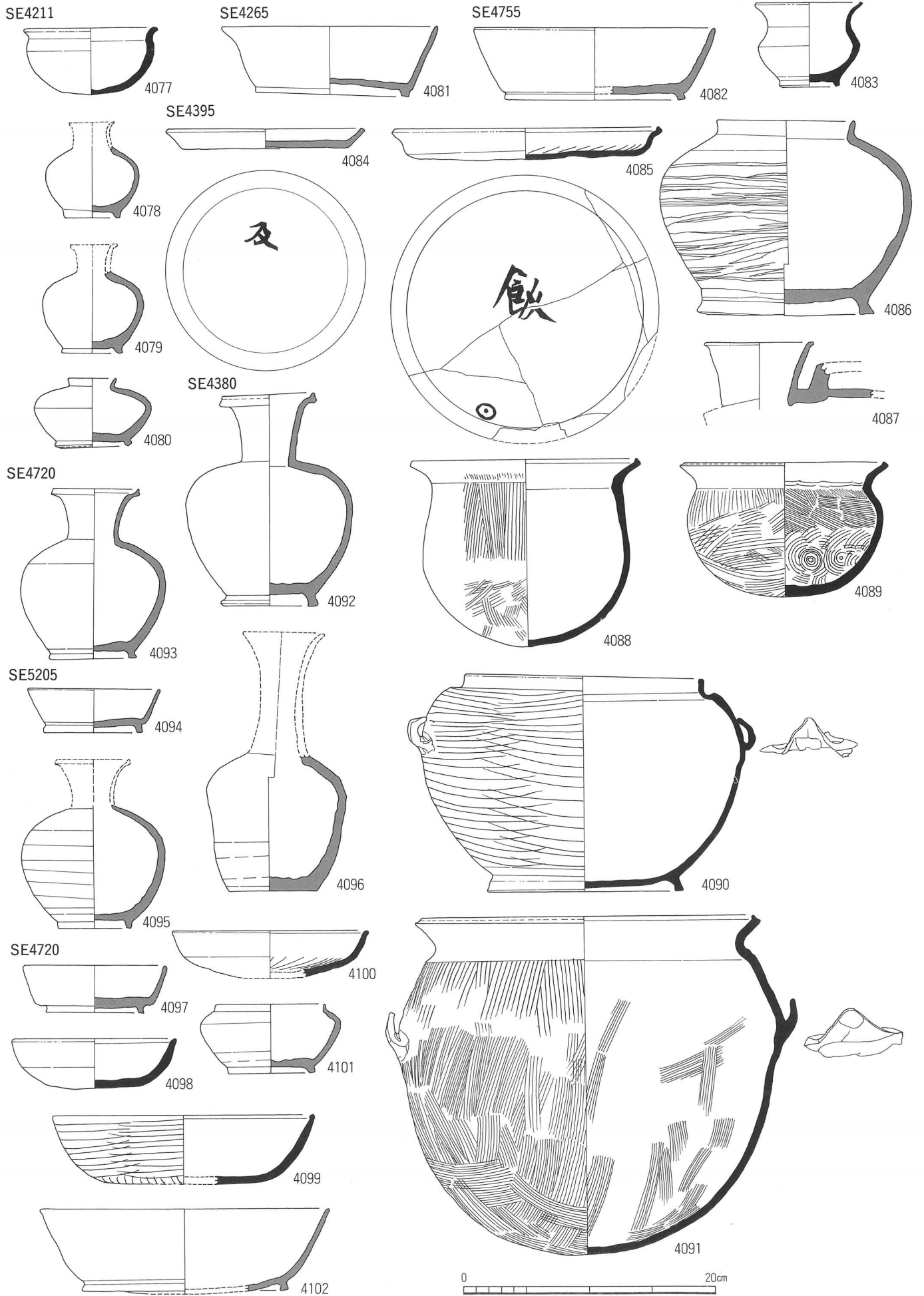

SE4340

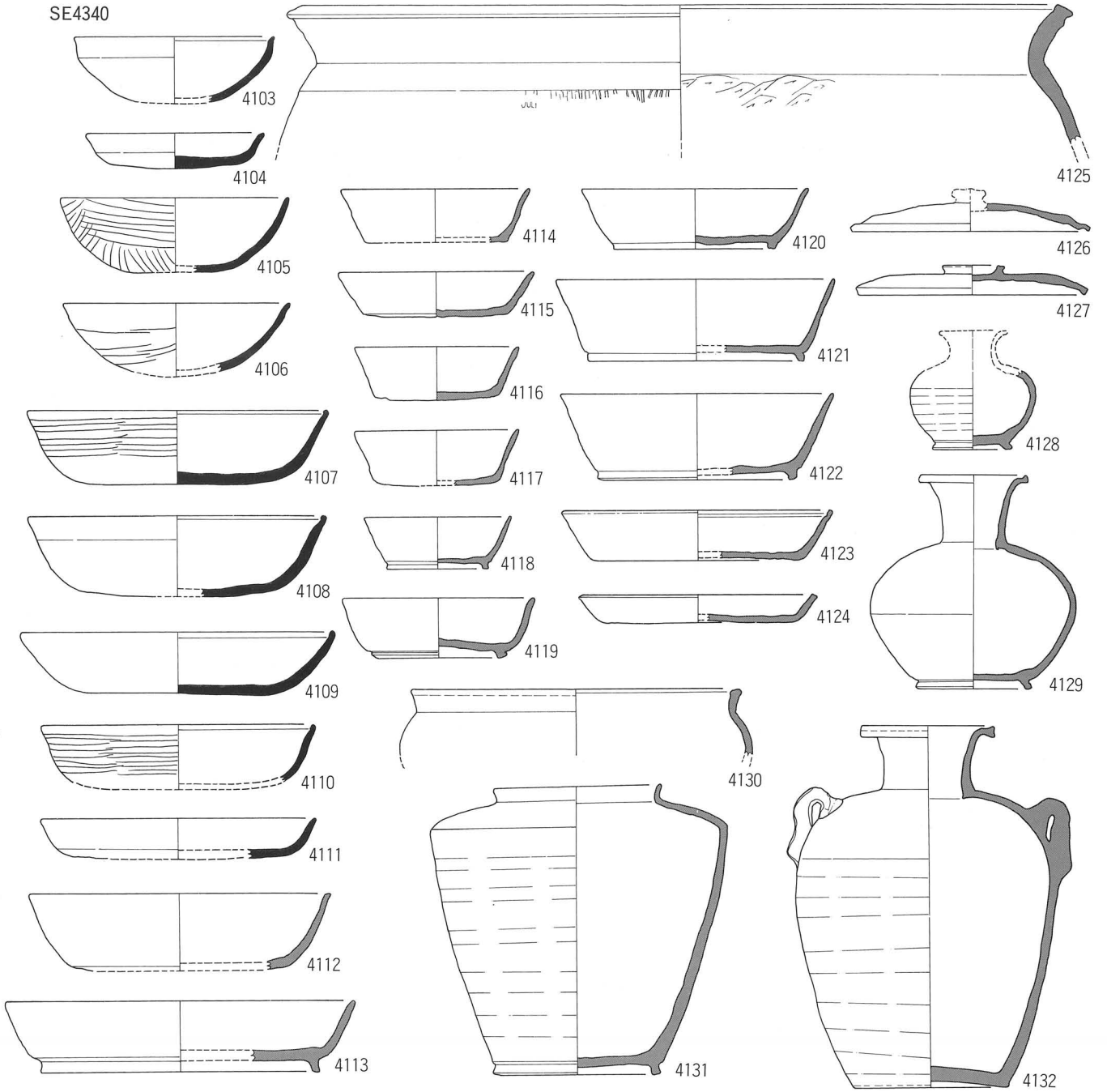

SE4225

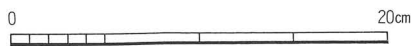
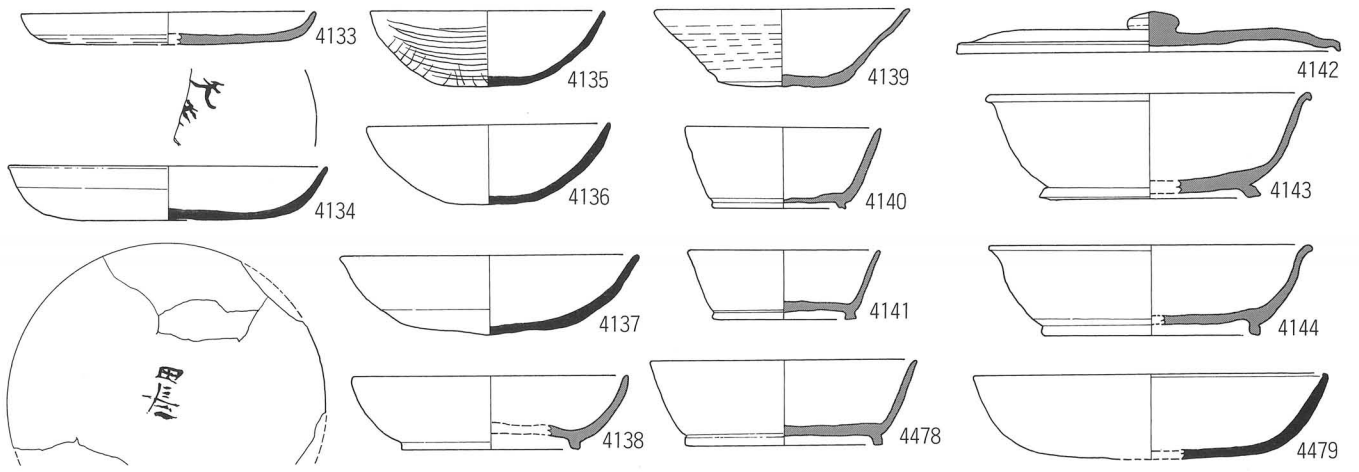

SE4498

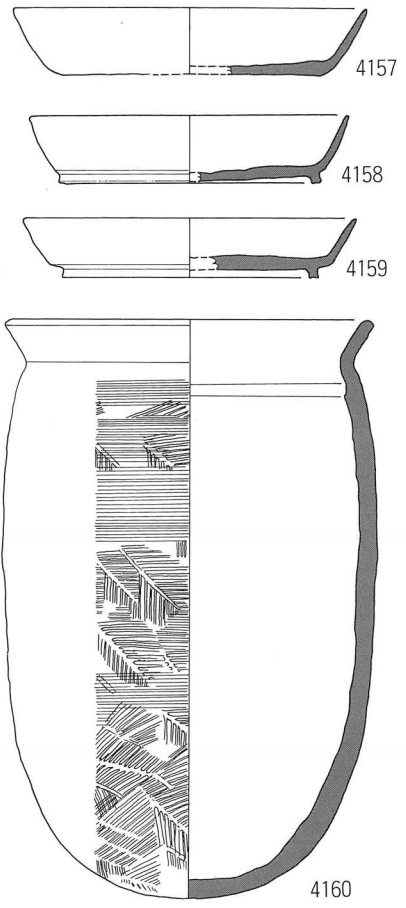
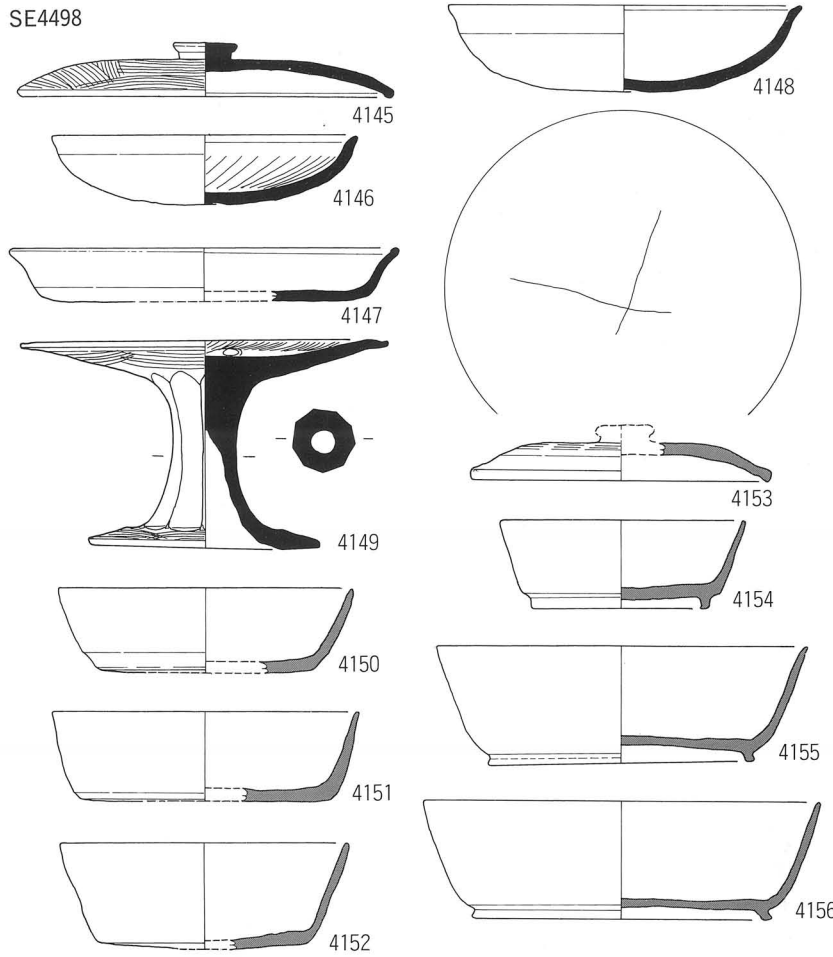

SE4530

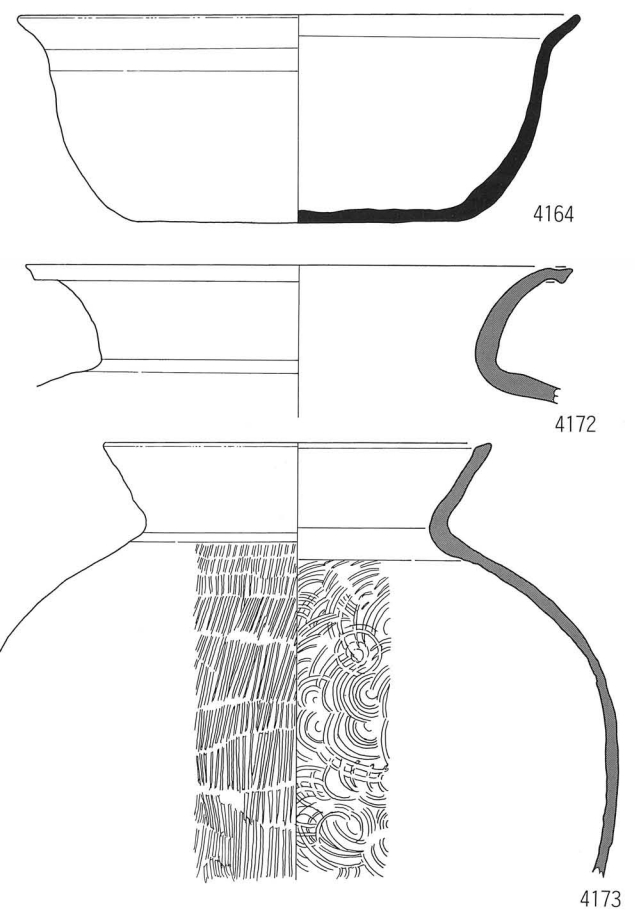
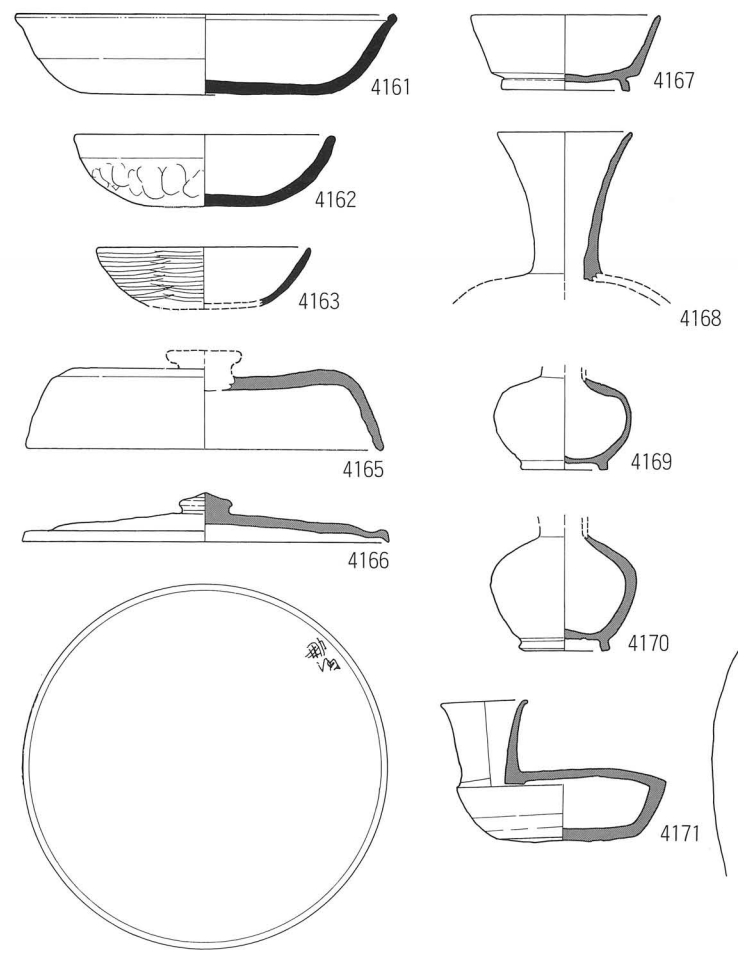

SE4497

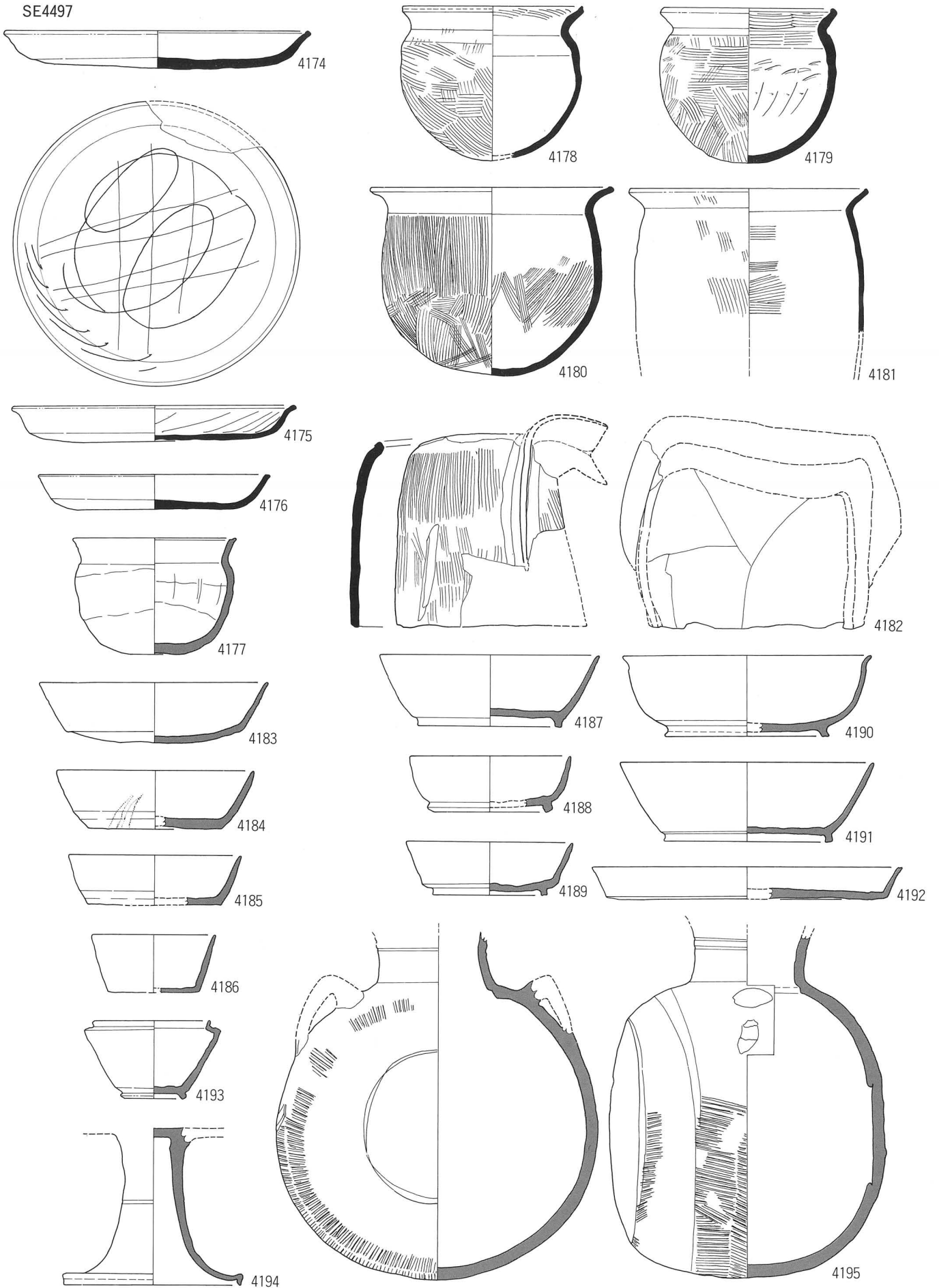

0 20cm

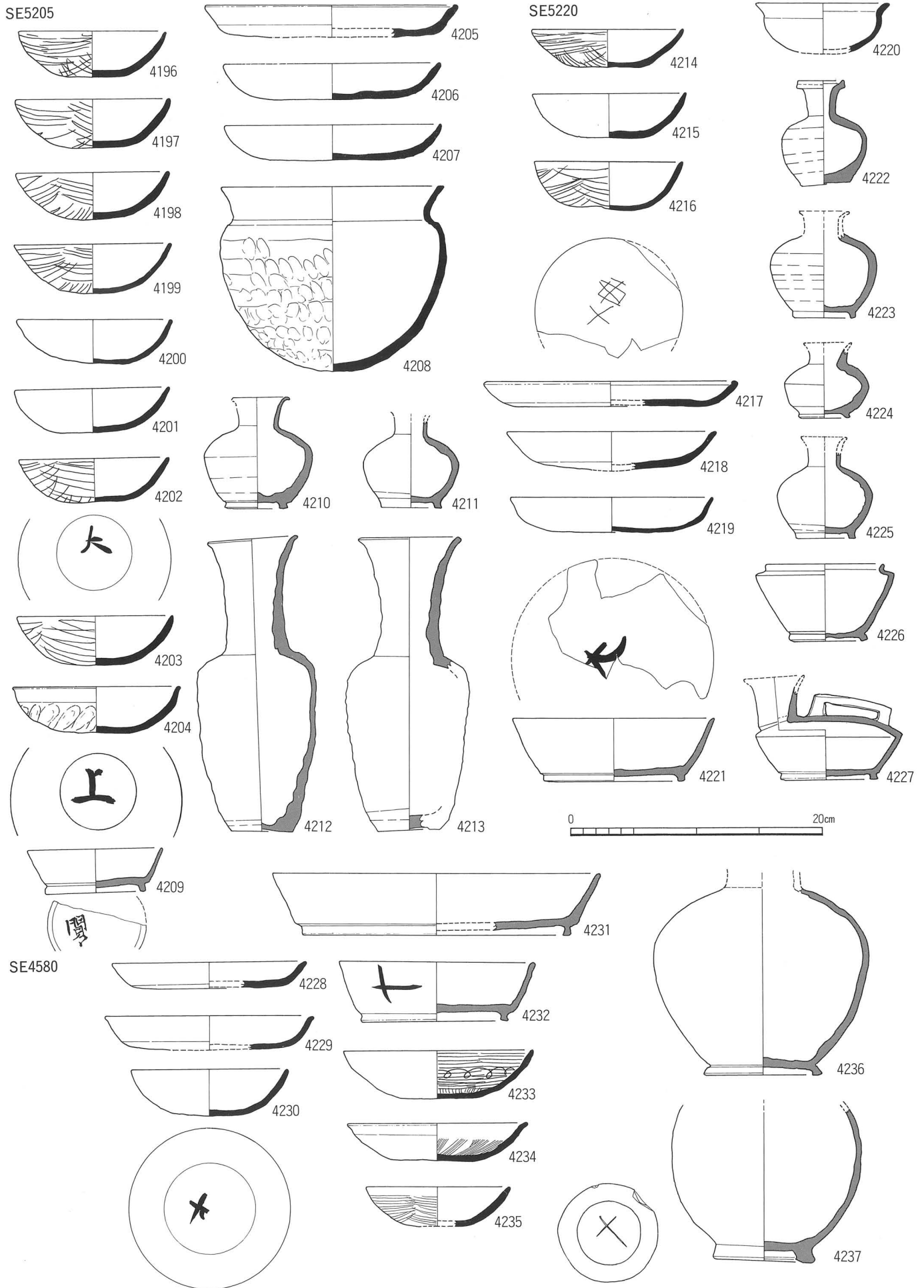

SE4760

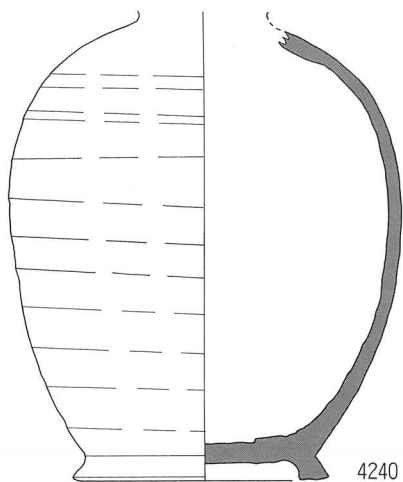
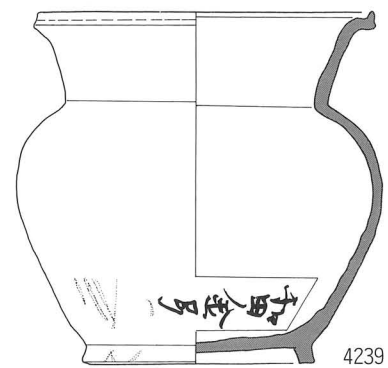
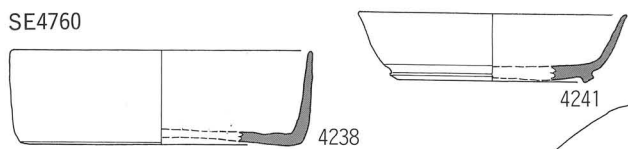

SE4815

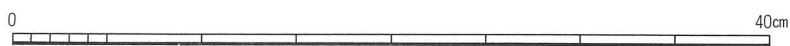
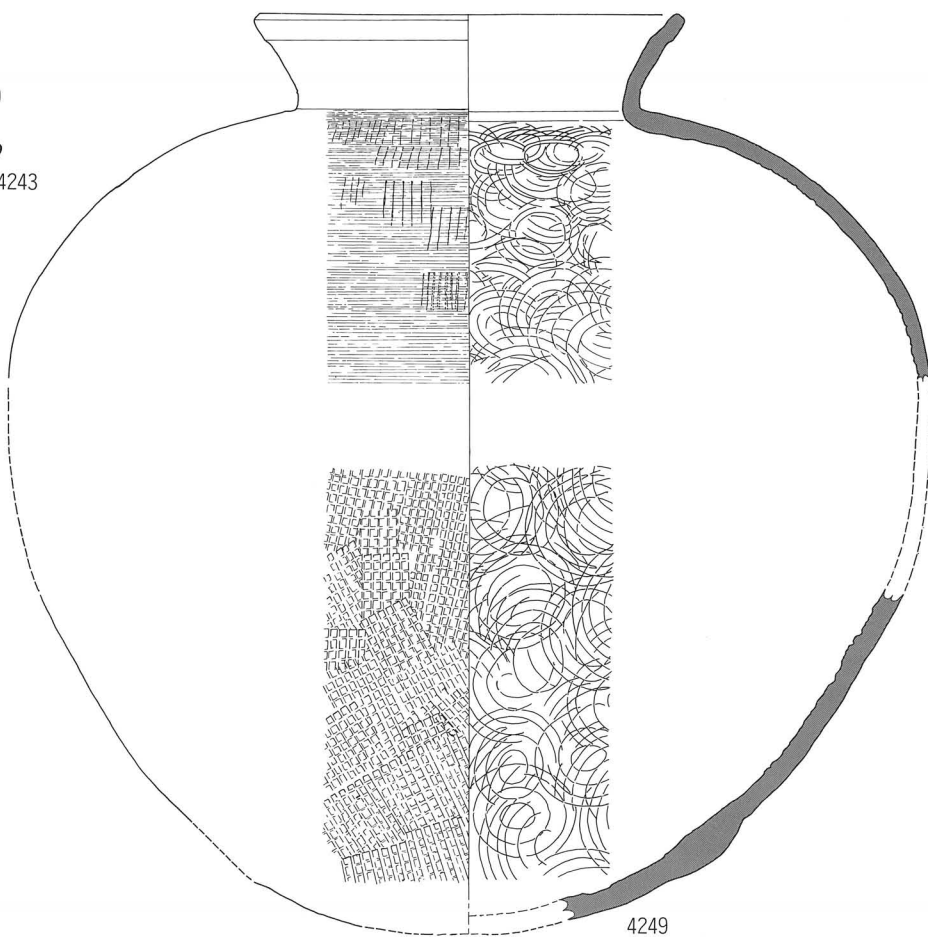
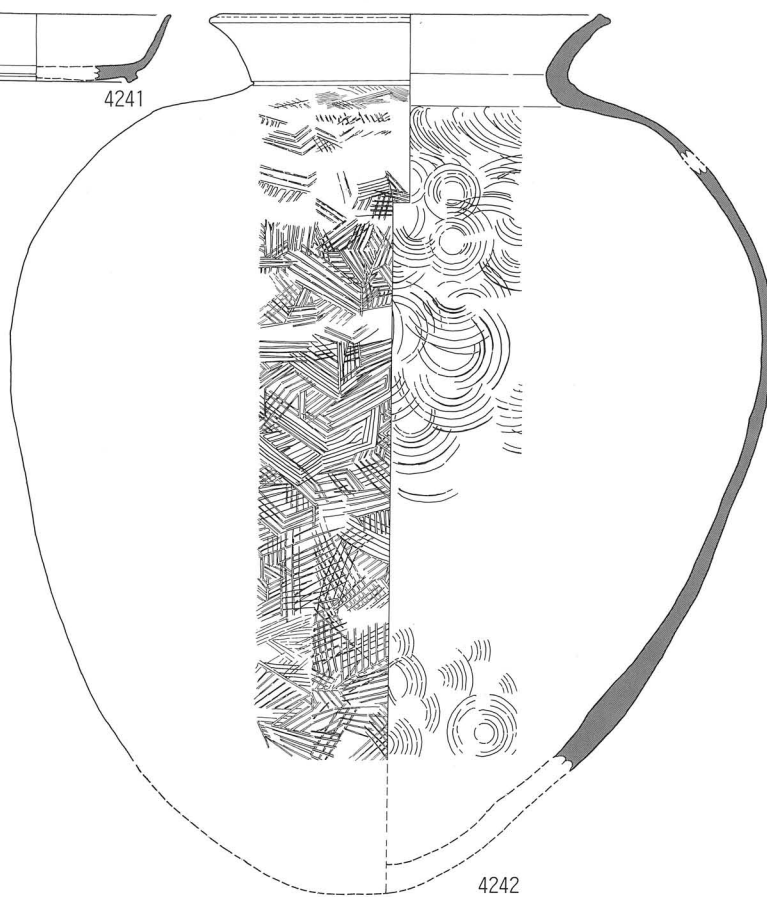
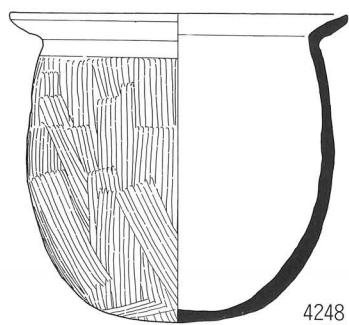
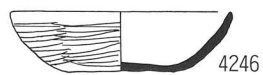

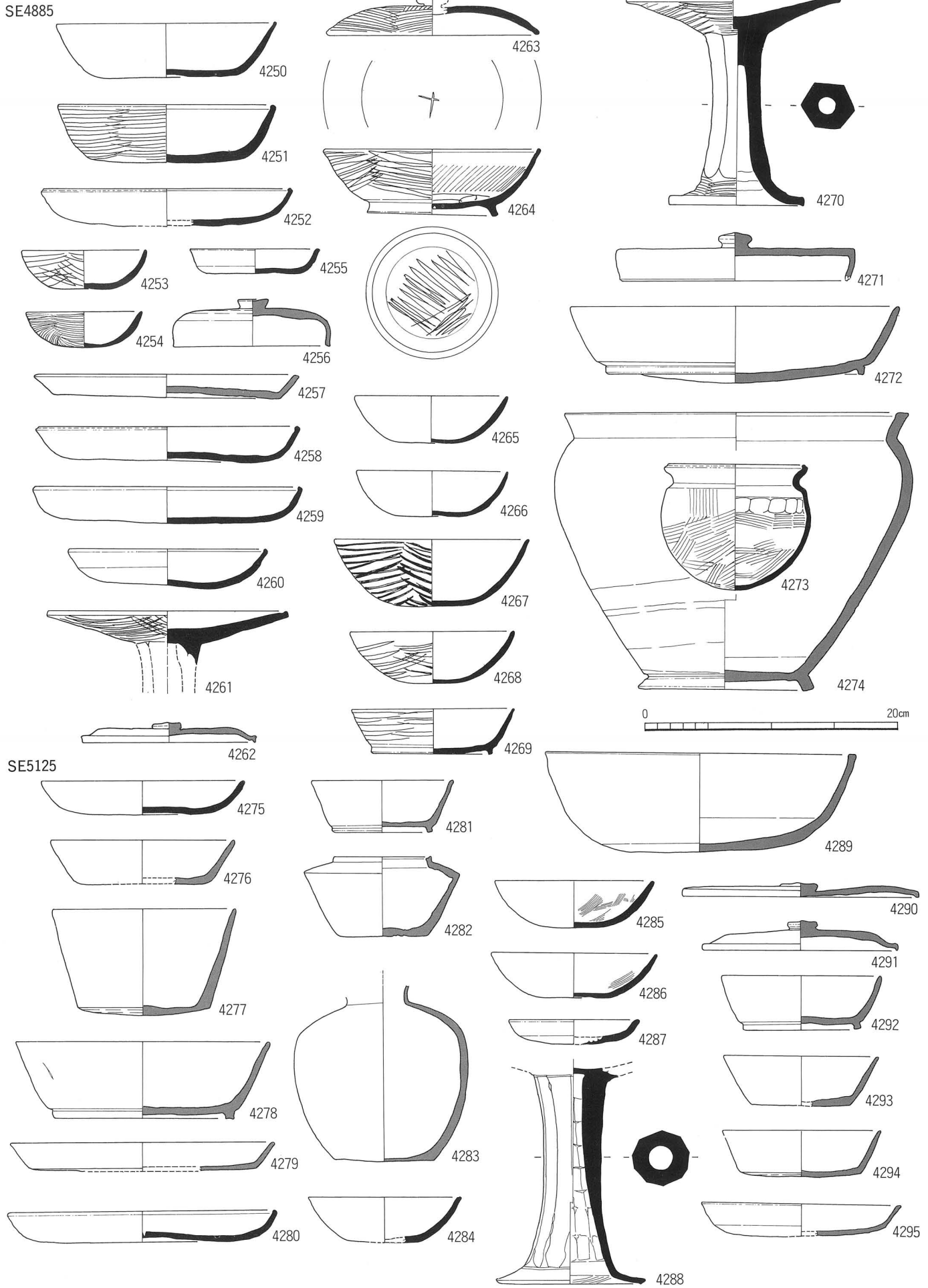

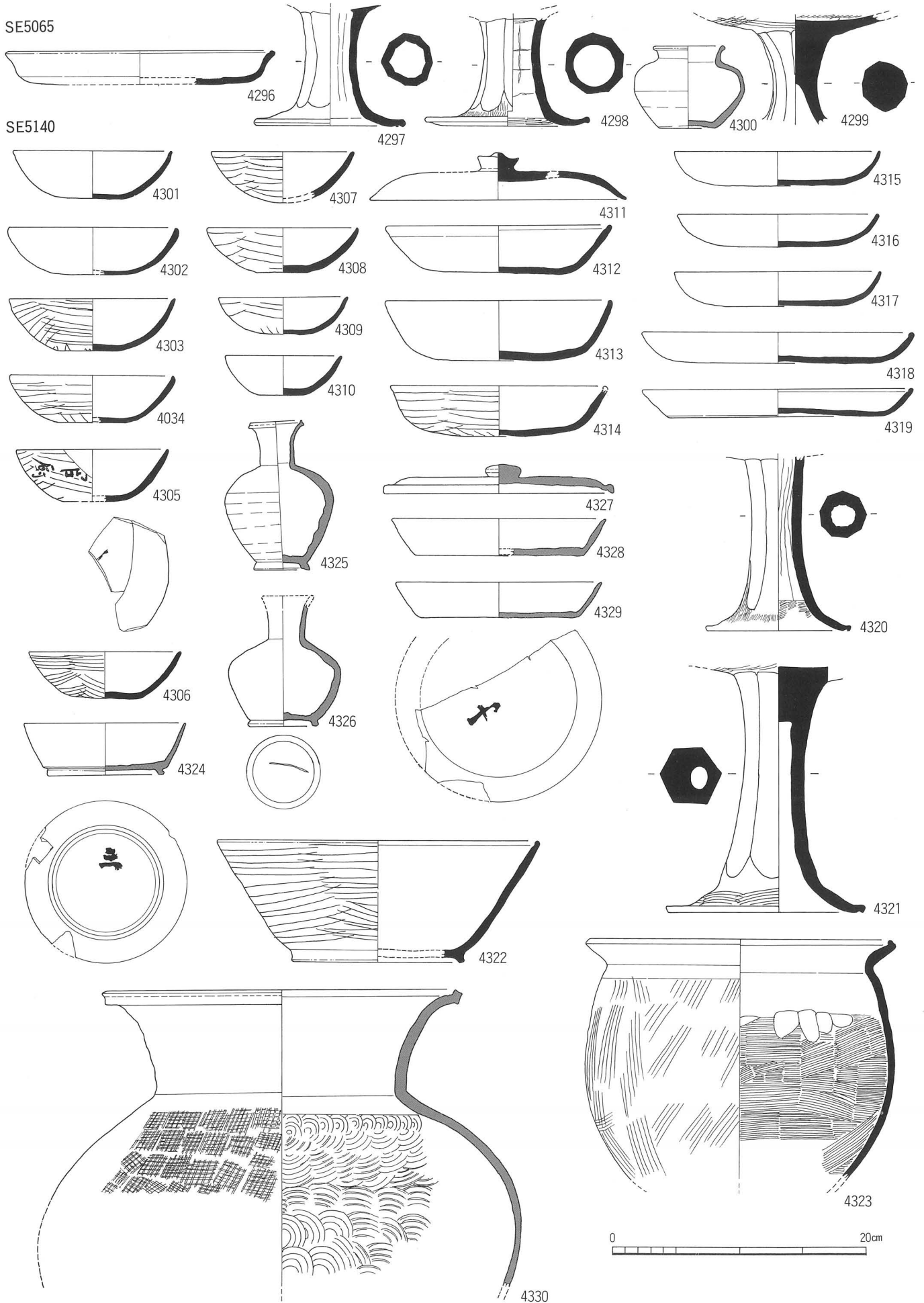

SE5135

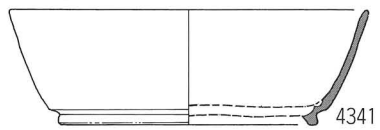
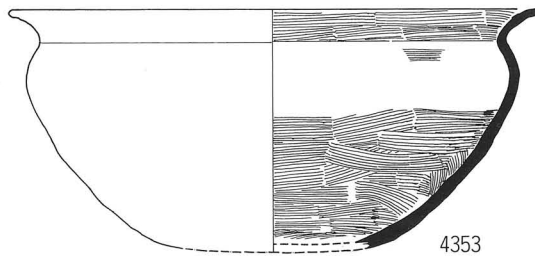
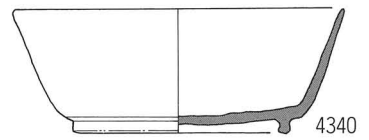
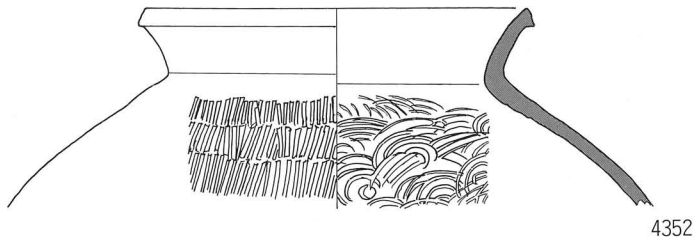
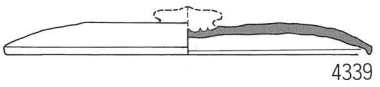
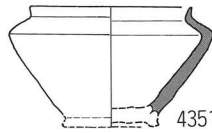
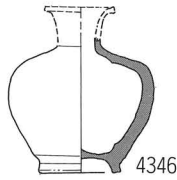
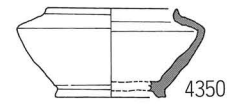
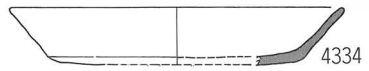
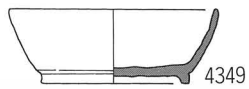
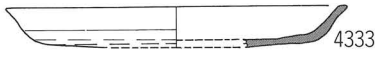
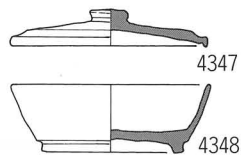
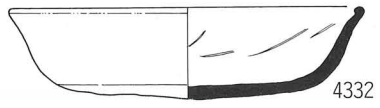
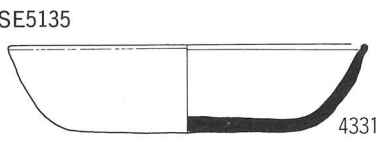

SE5355

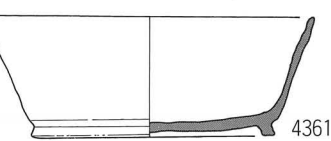
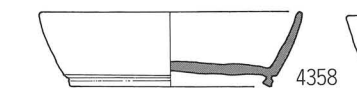
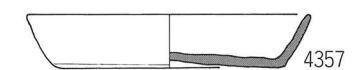
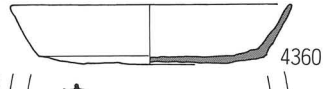
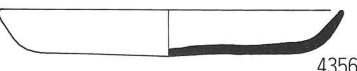
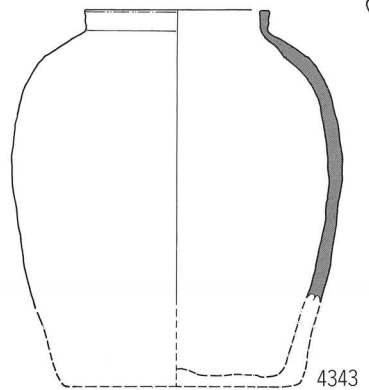
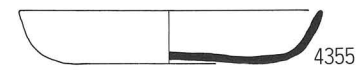
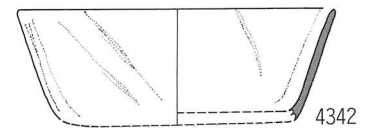
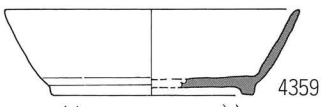

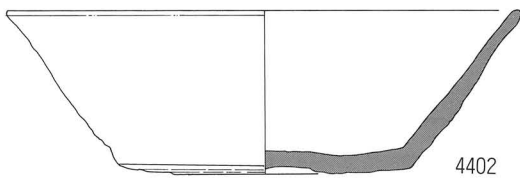
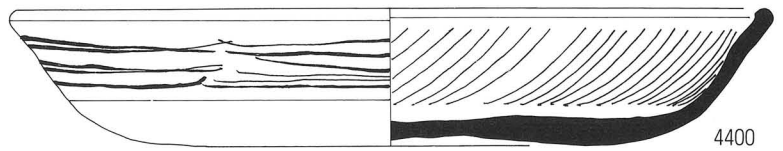
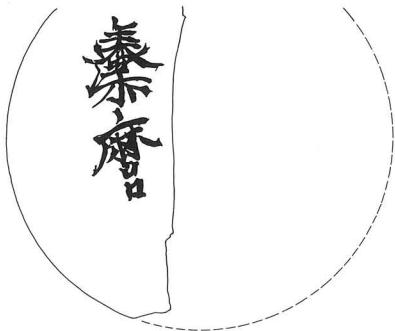
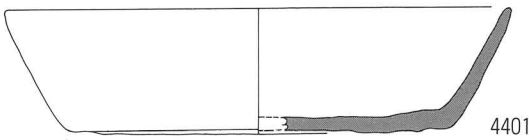
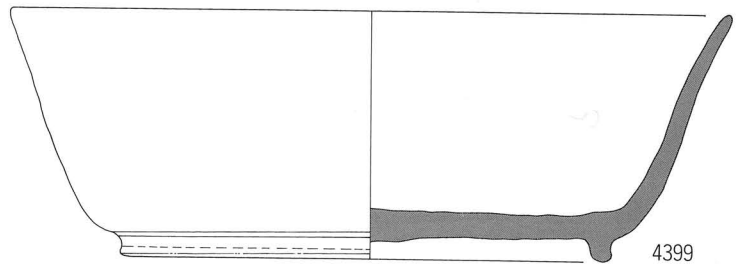
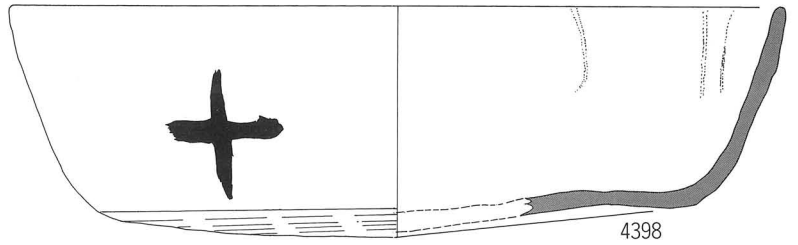
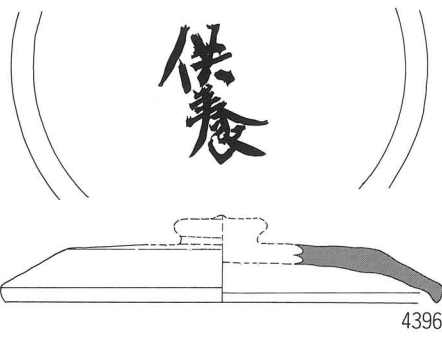
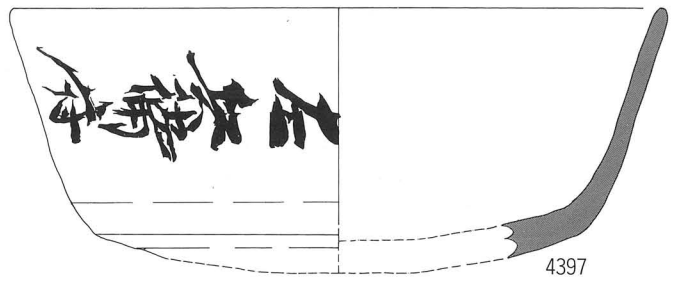
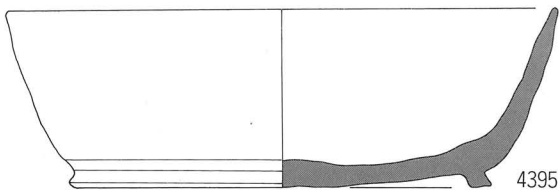

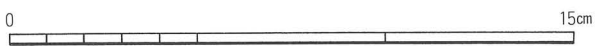
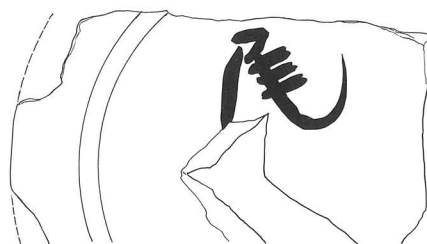
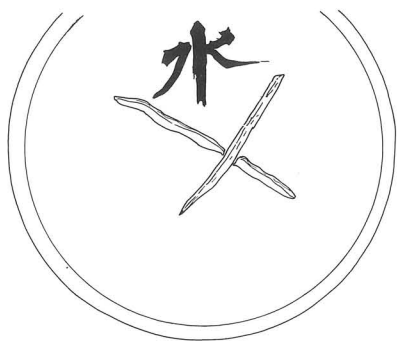
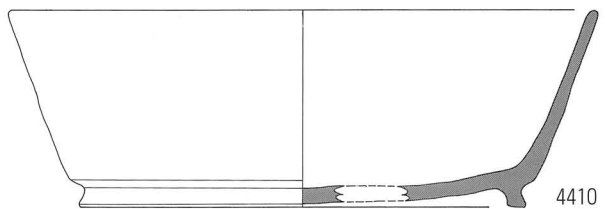
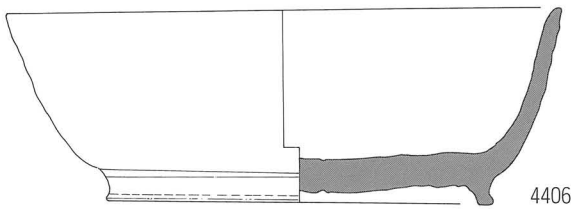
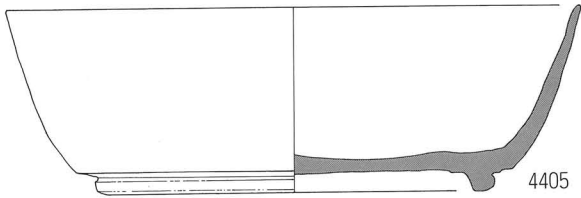
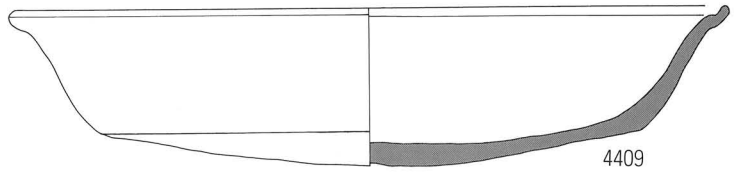
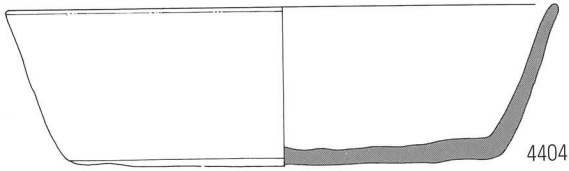
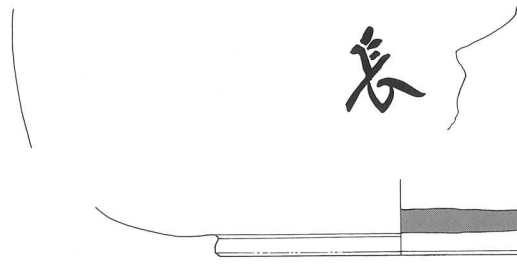
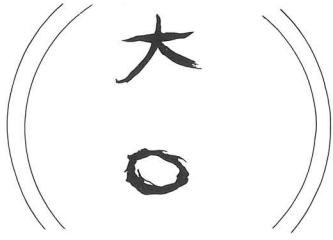
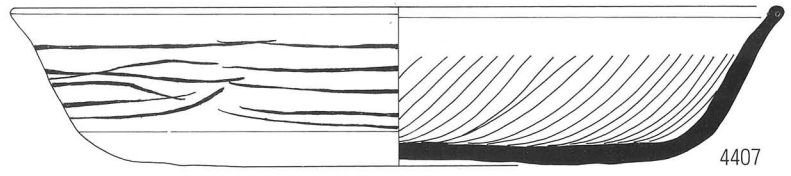
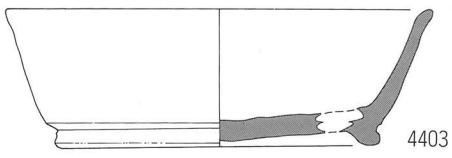

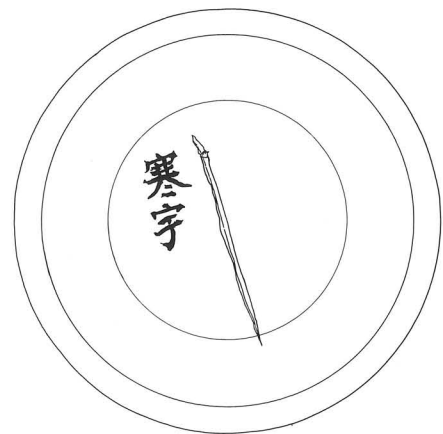
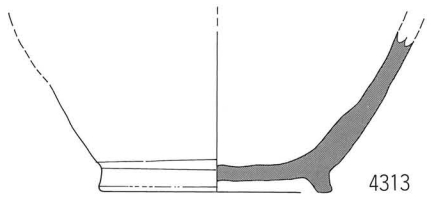
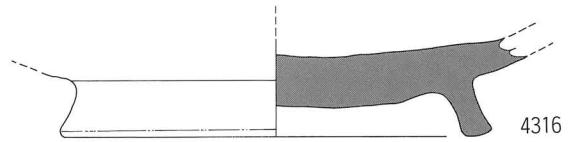
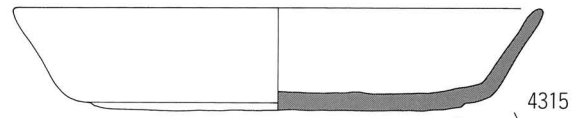
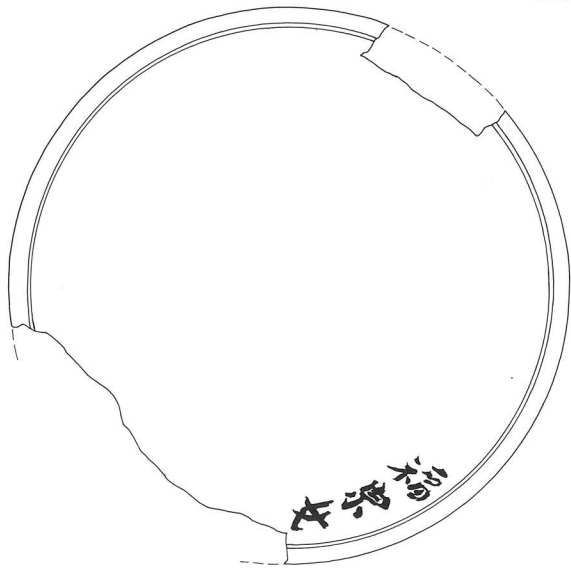
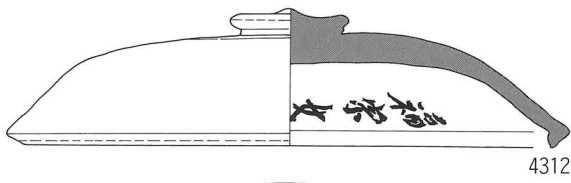
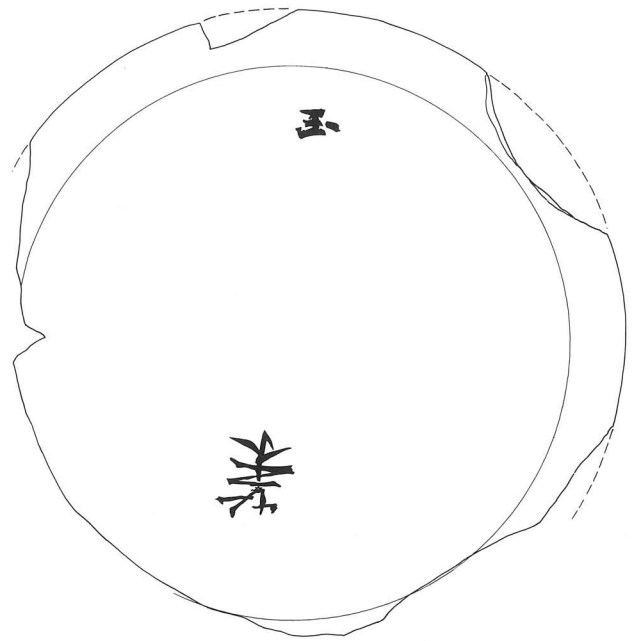
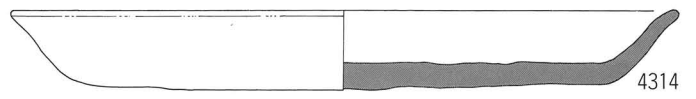
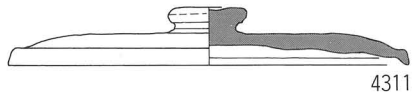

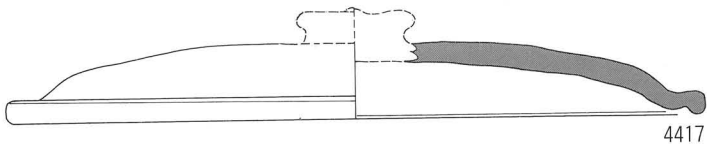

4417

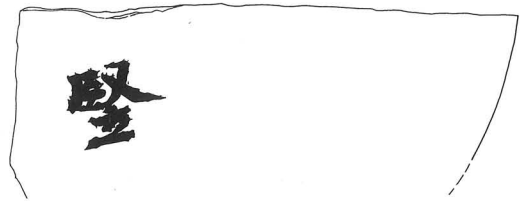

堅

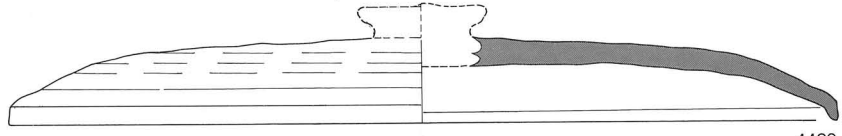

4420

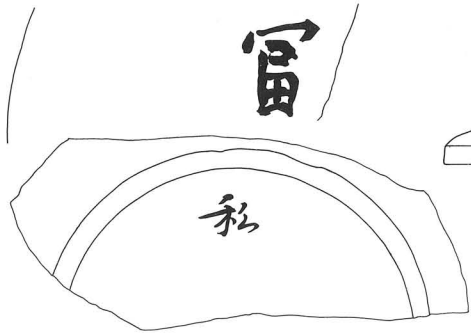

富

私

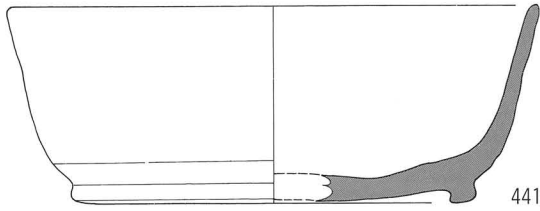

4418

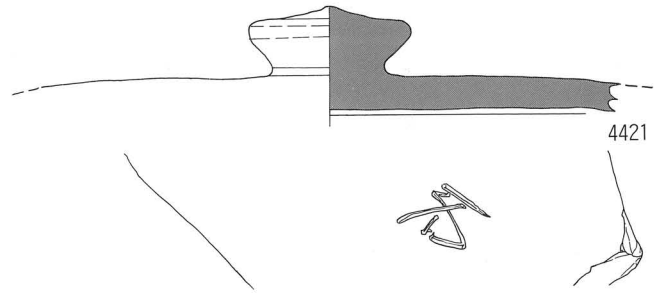

4421

子

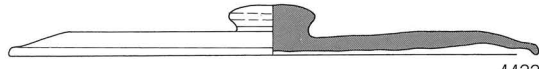

4422



下

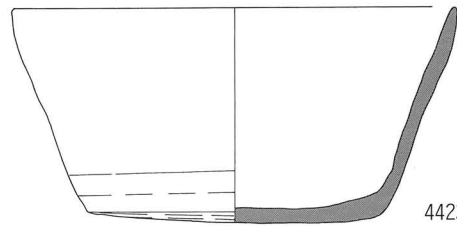

4423

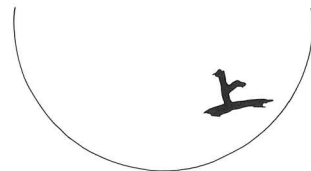
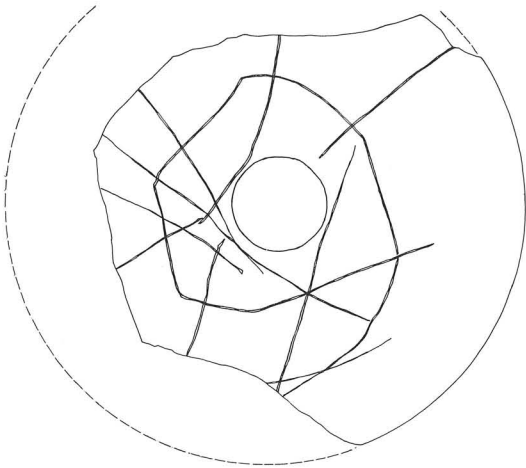

上

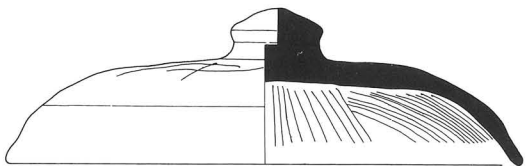

4419

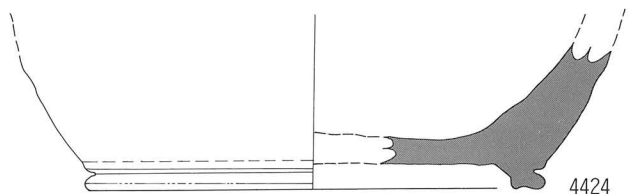

4424

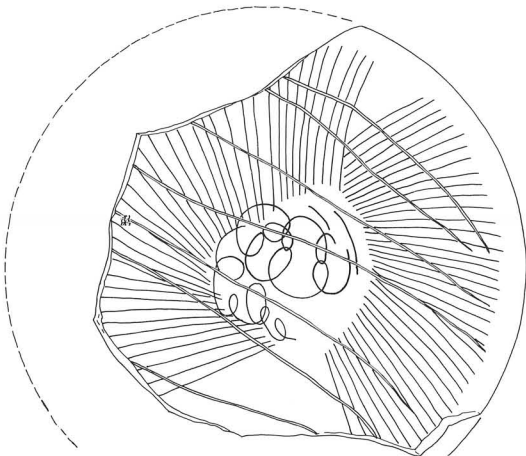

15cm

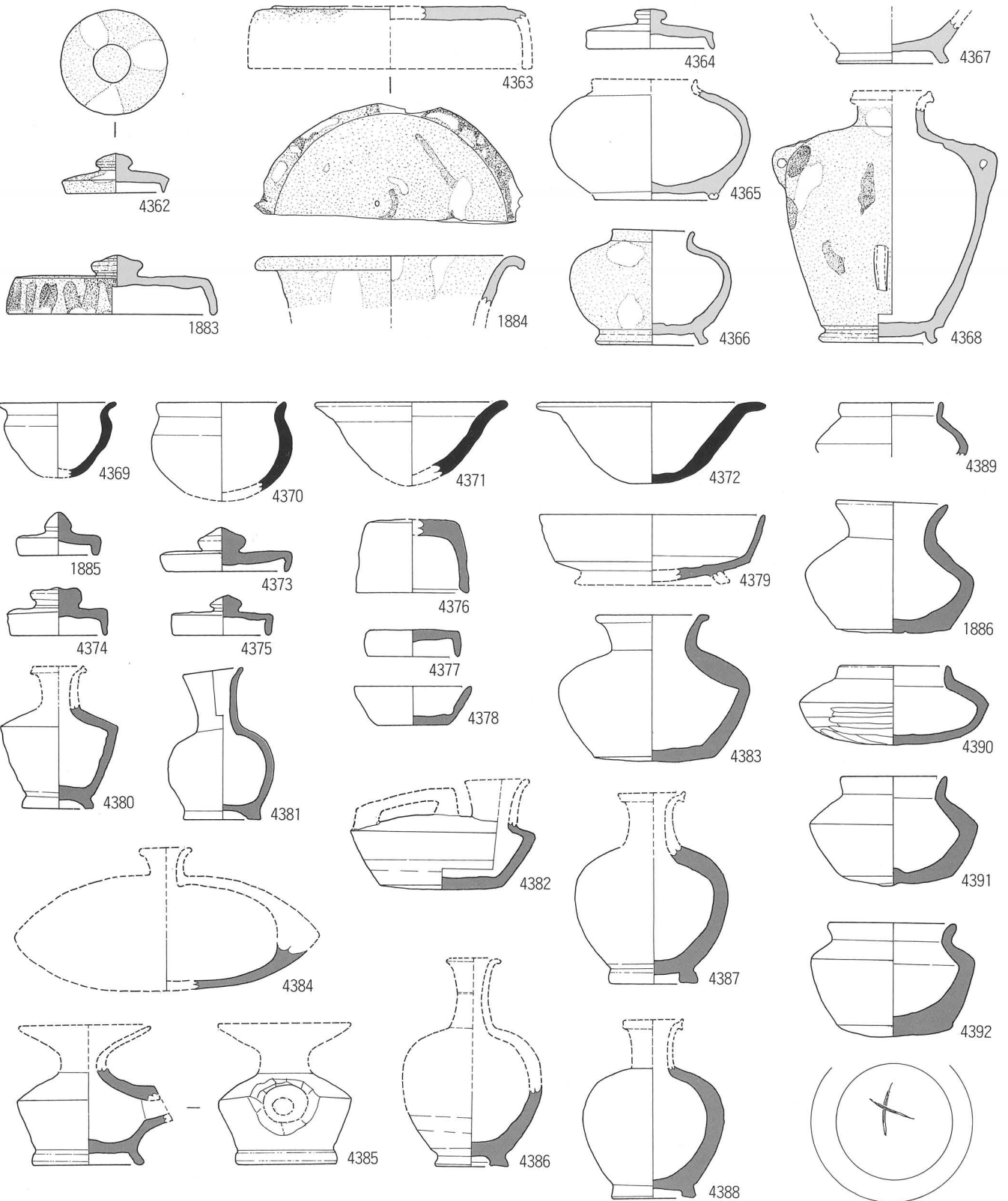

4362~4368 奈良三彩

その他 ミニチュア土器

1:4

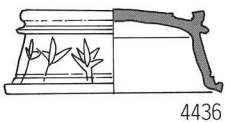
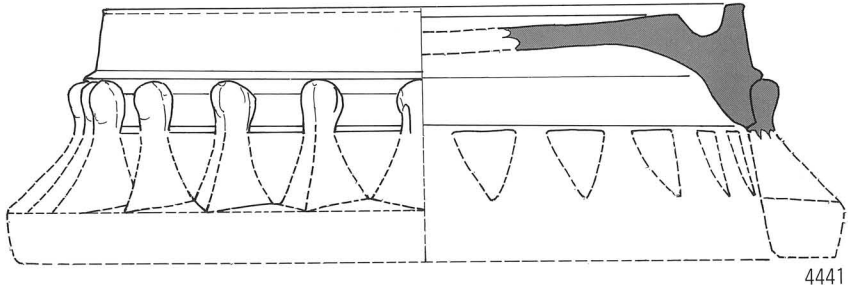
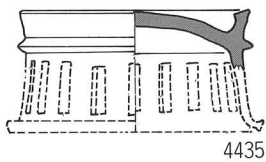
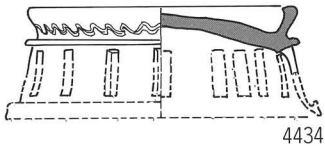
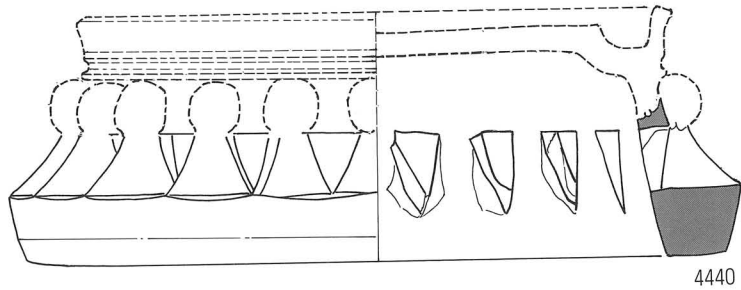
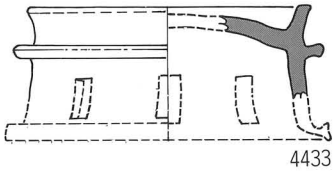
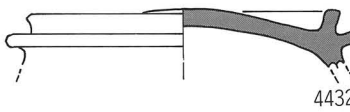
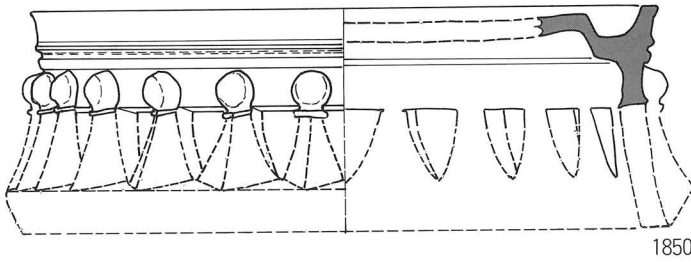
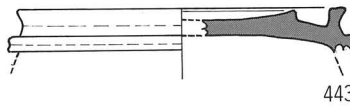
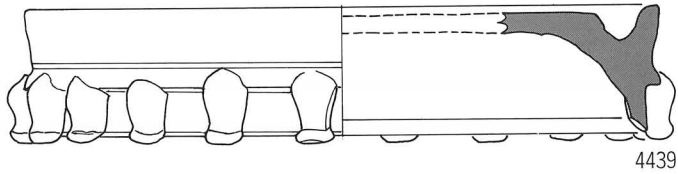
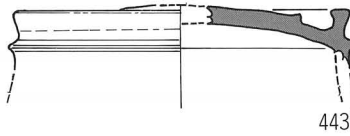
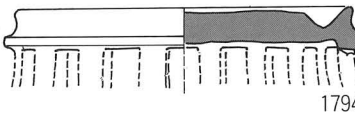
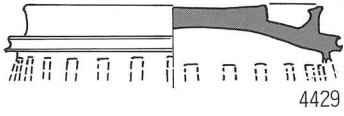
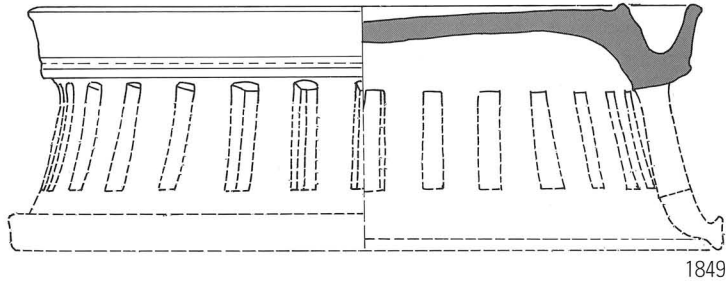
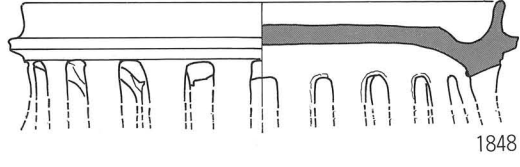
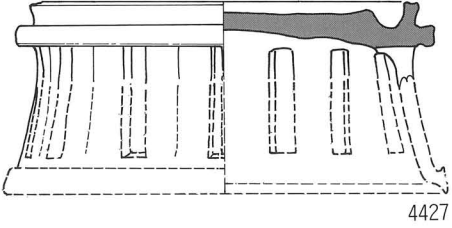
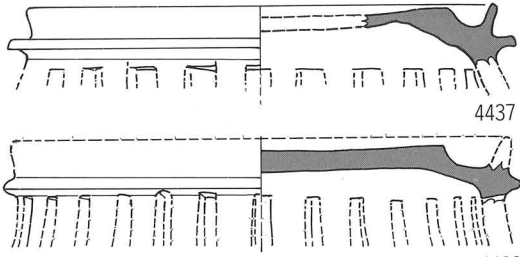
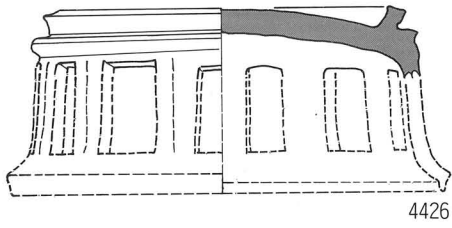

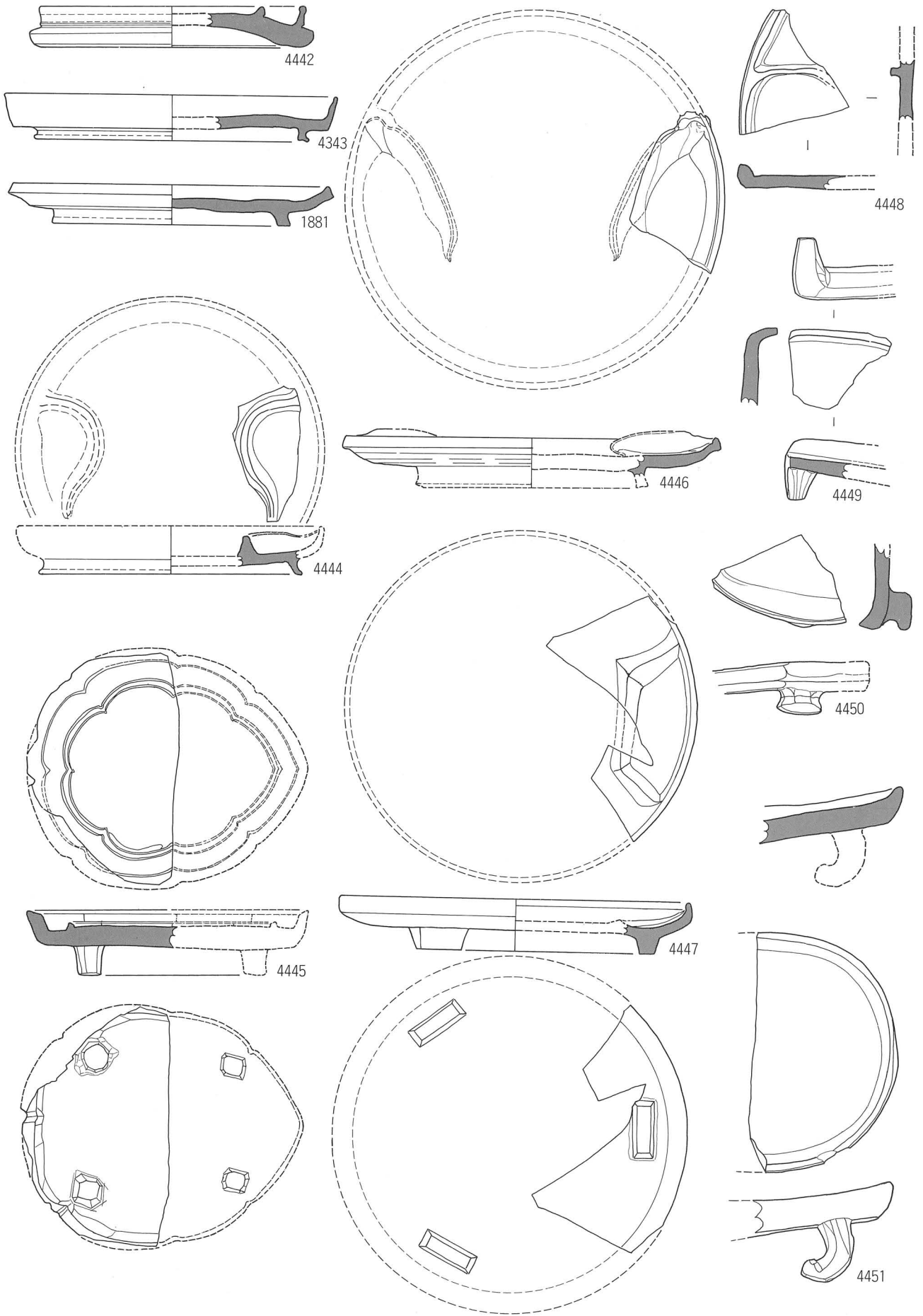

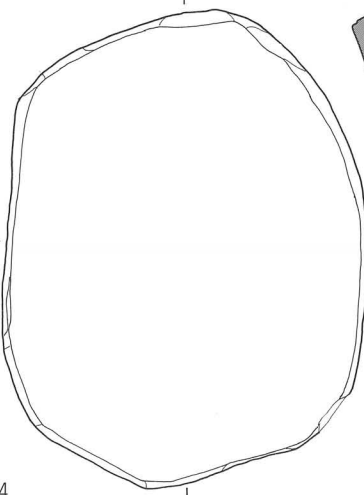
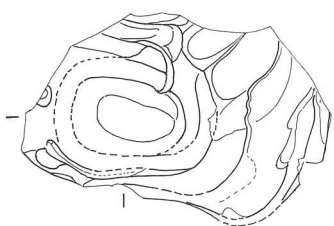
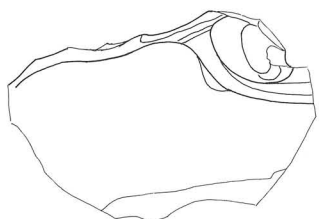
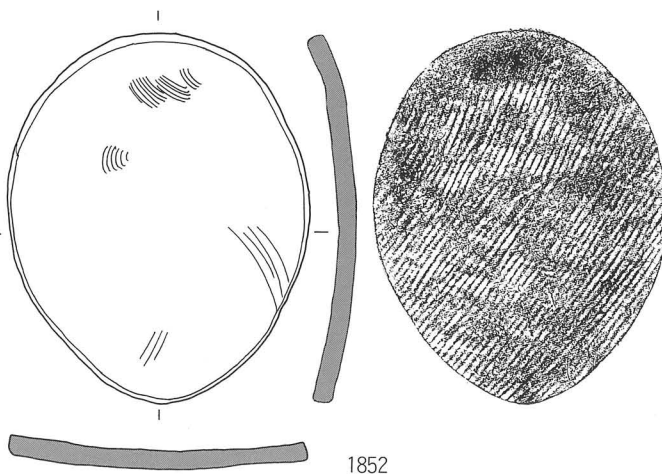
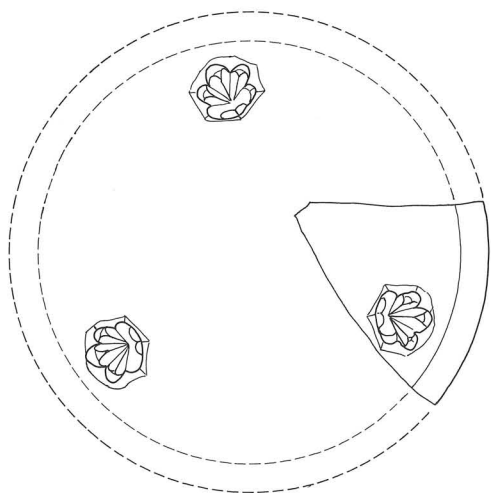
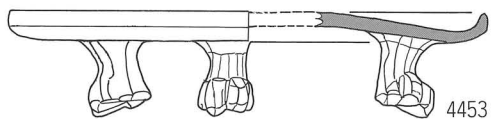
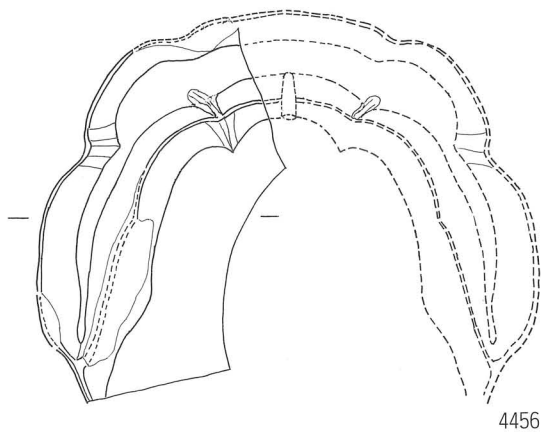
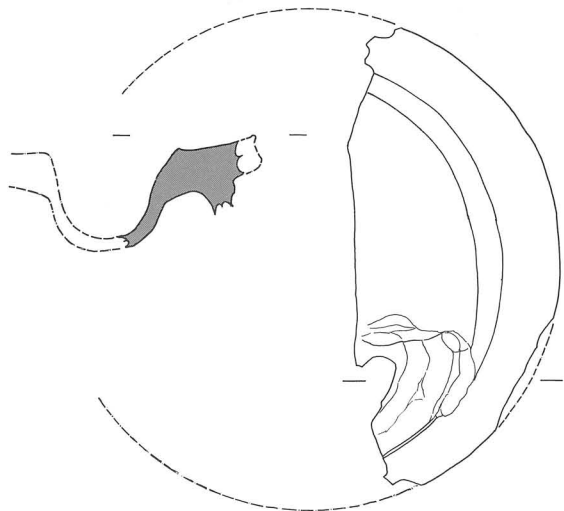
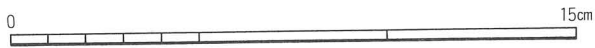
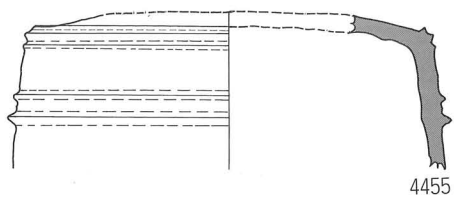
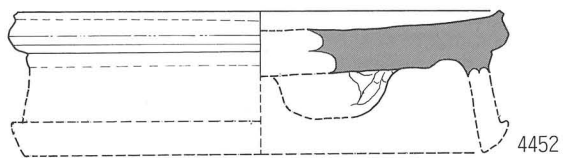

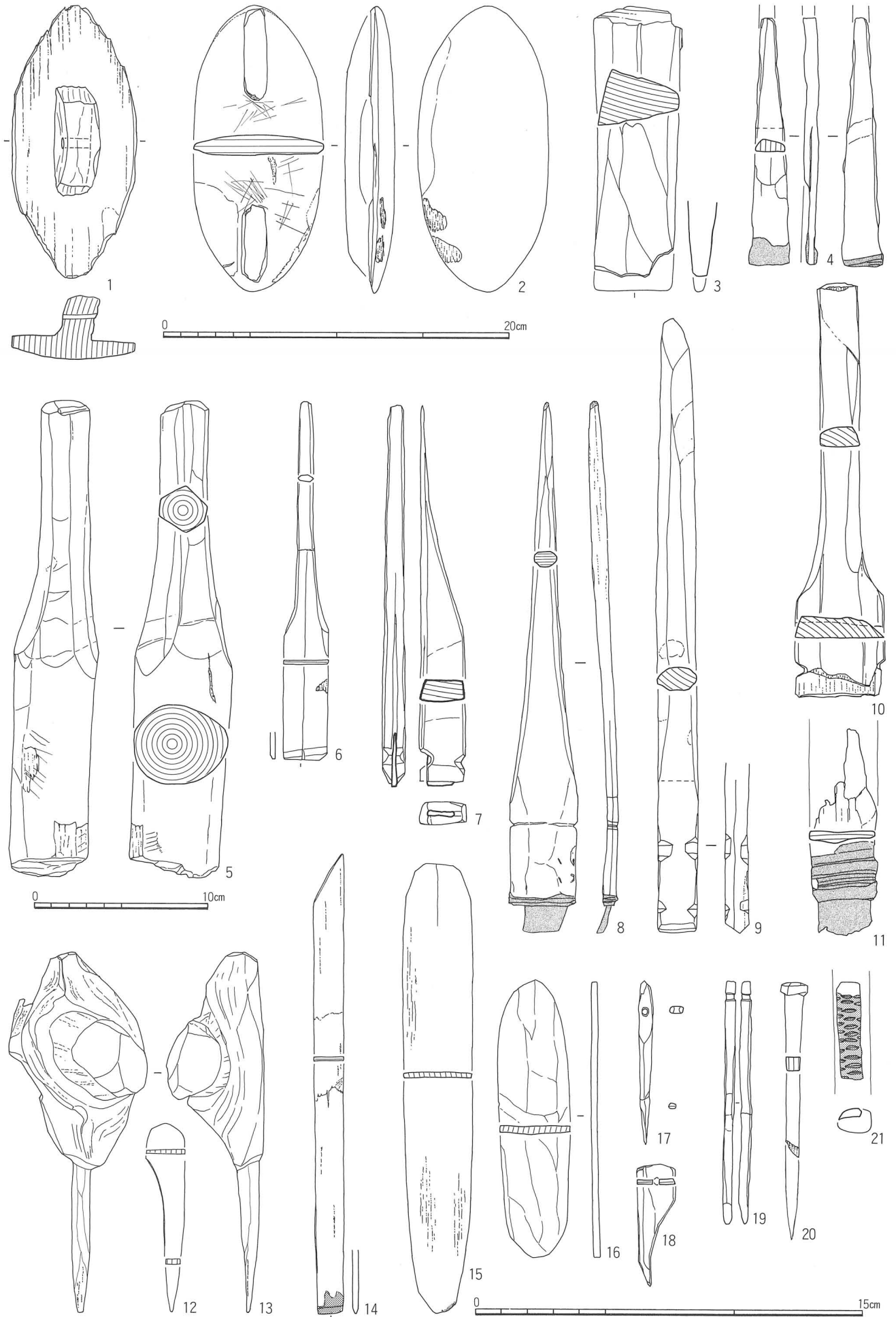

3・4・6~21 1:2

1・2・5 1:3

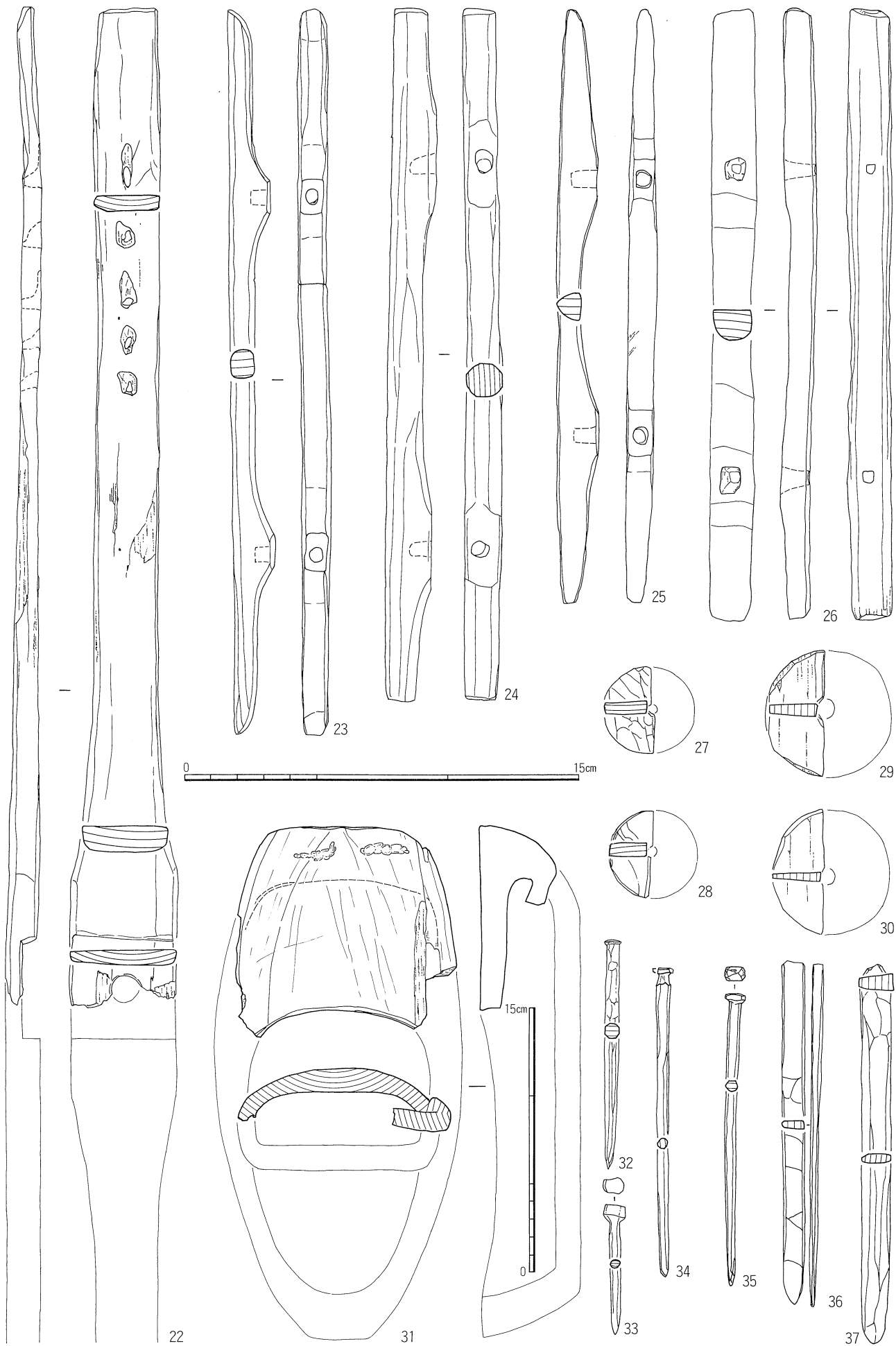

22~30・32~37 1 : 2

31 1 : 3

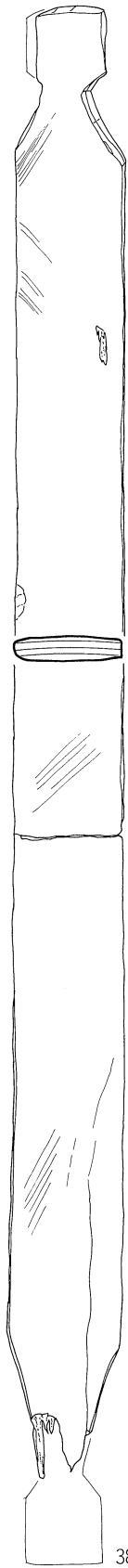

38

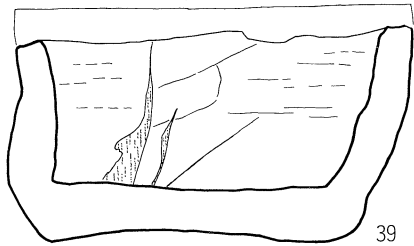
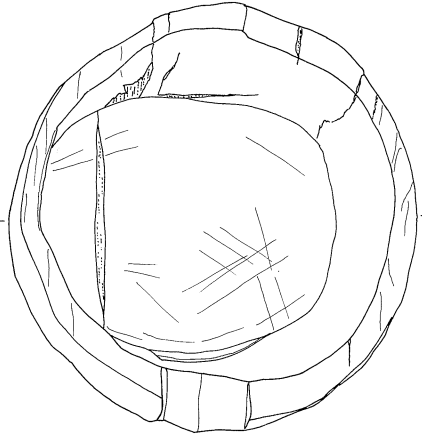
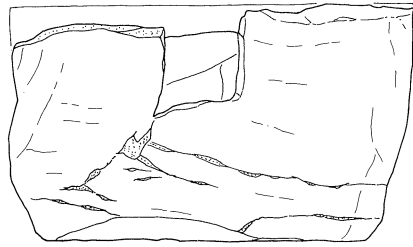

39

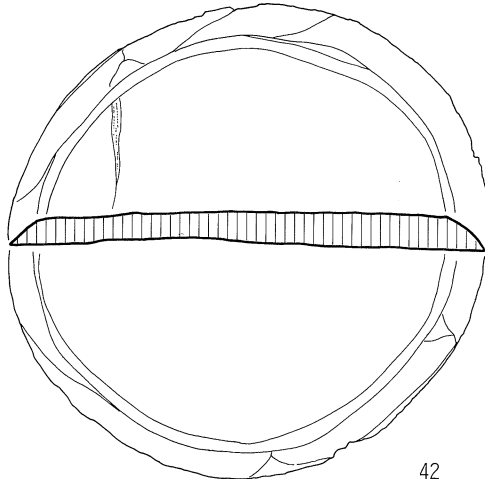

42

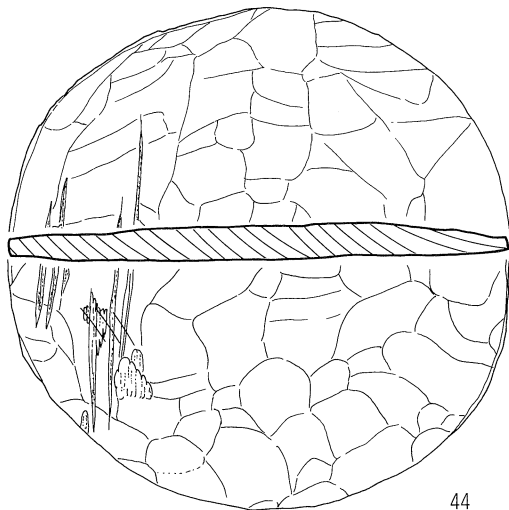

44

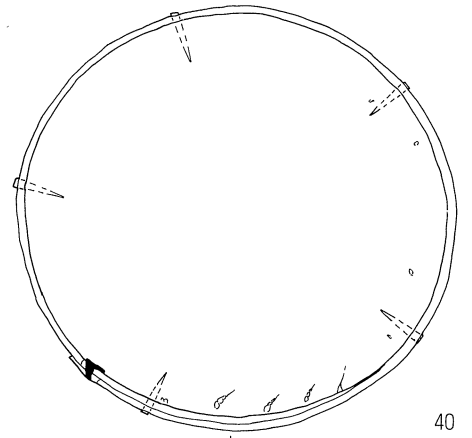

40

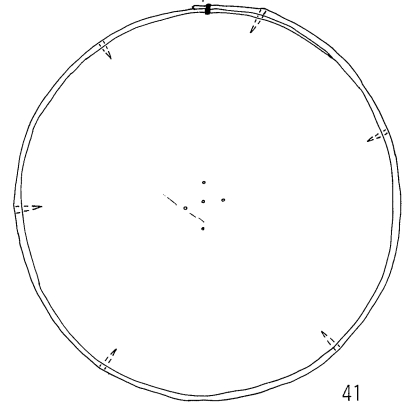
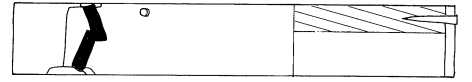

41

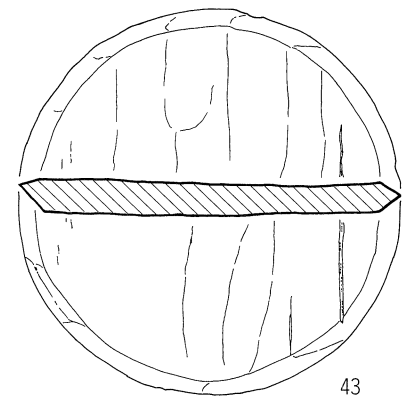

43

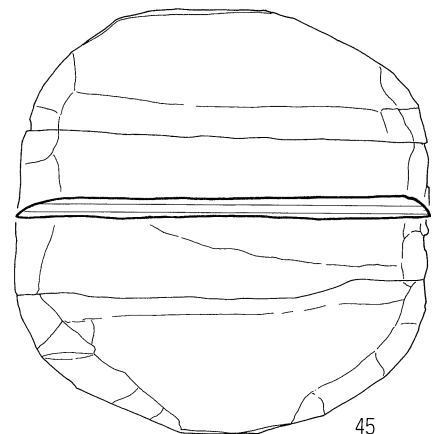

45

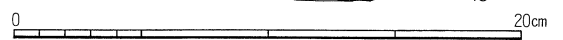

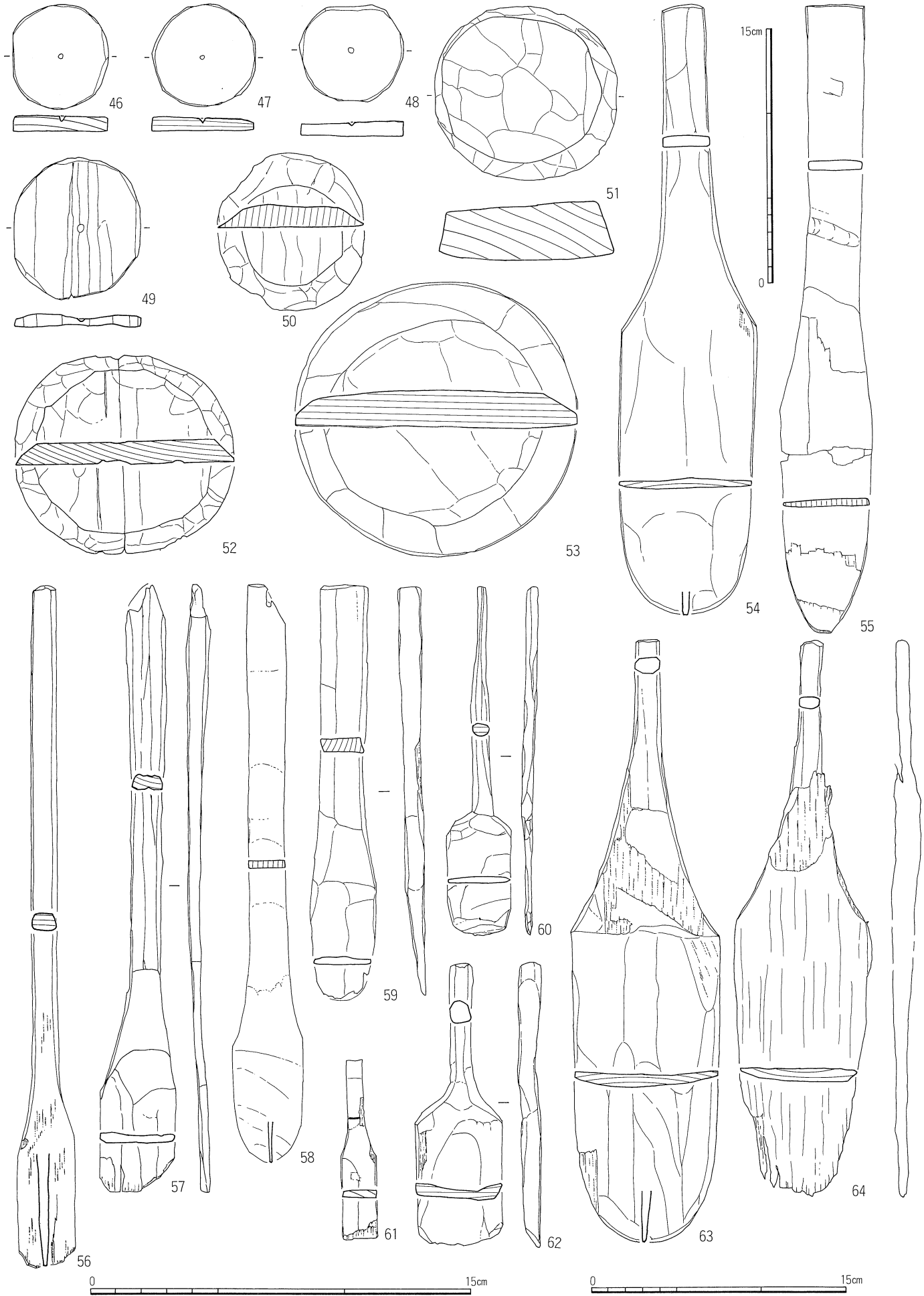

46~53・56~62 1:2

54・55・63・64 1:3

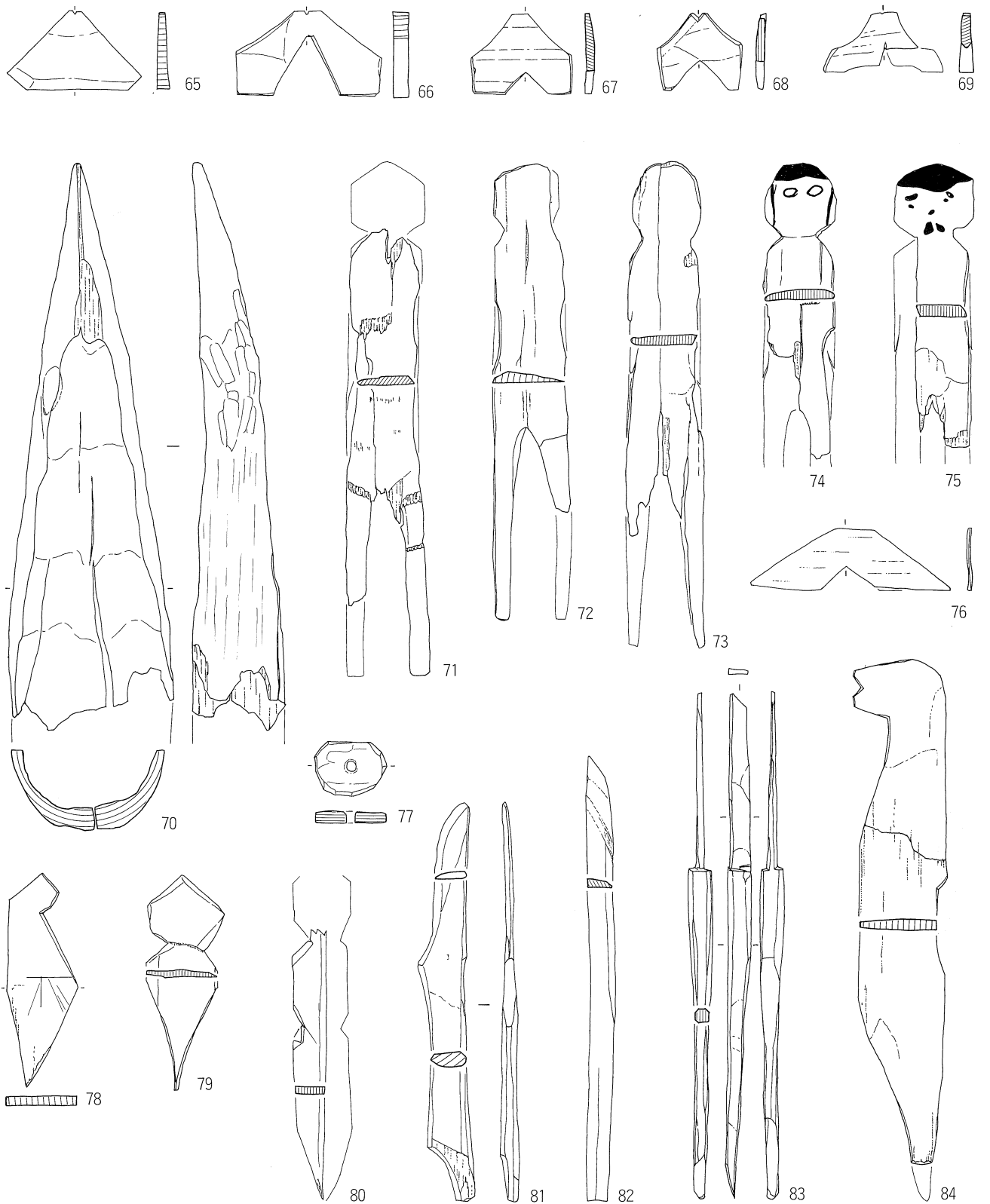

0 20cm

1:2

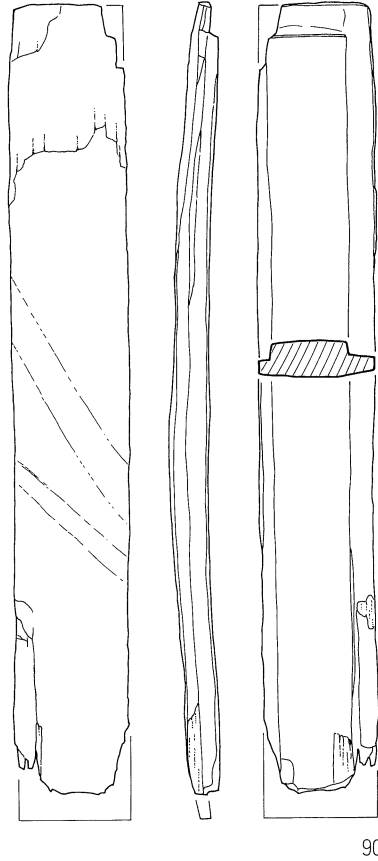
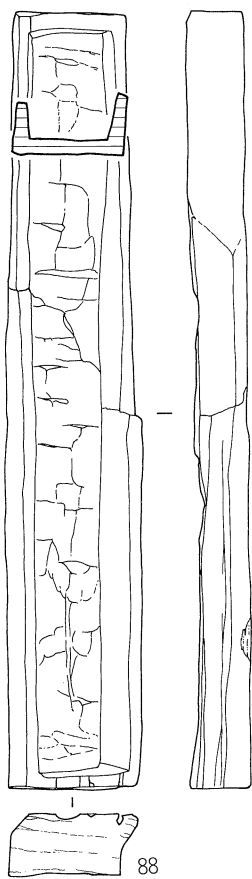
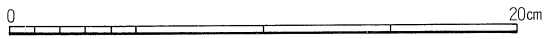
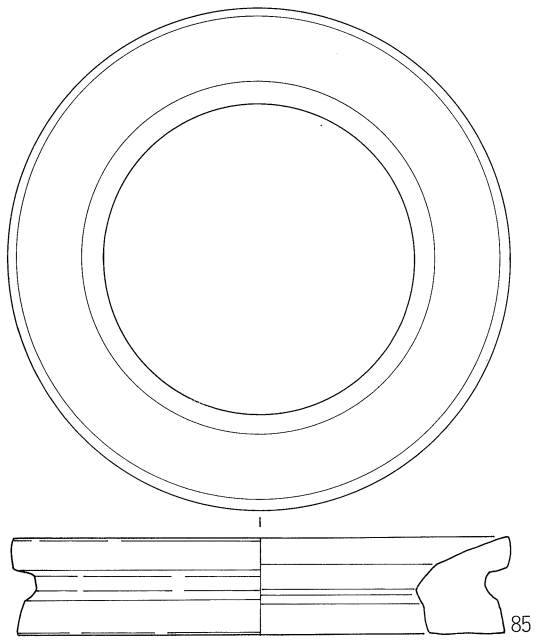

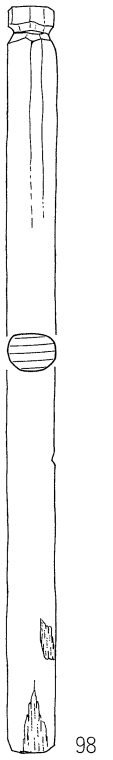
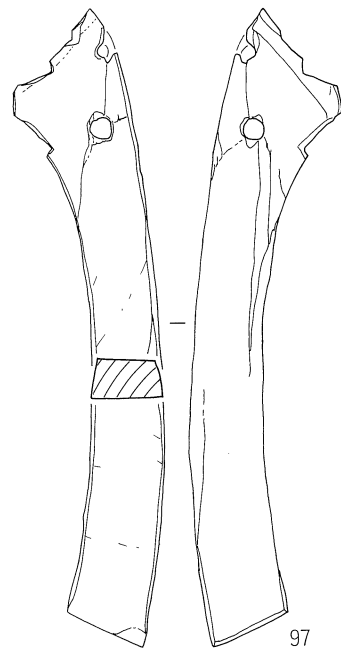
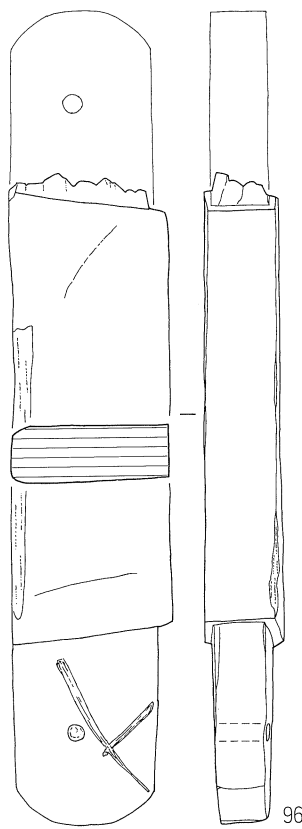
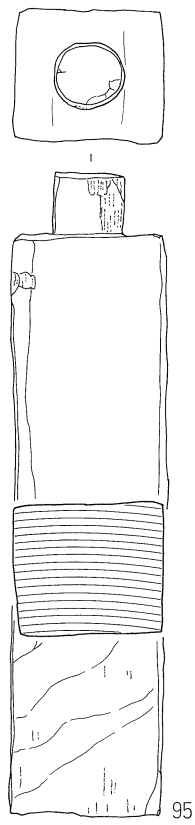
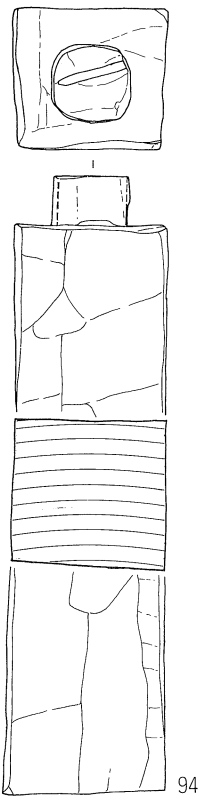
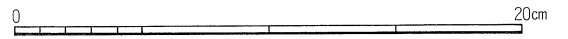
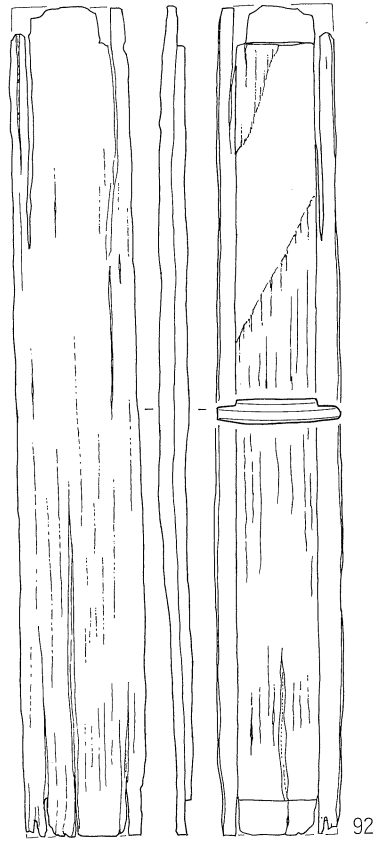
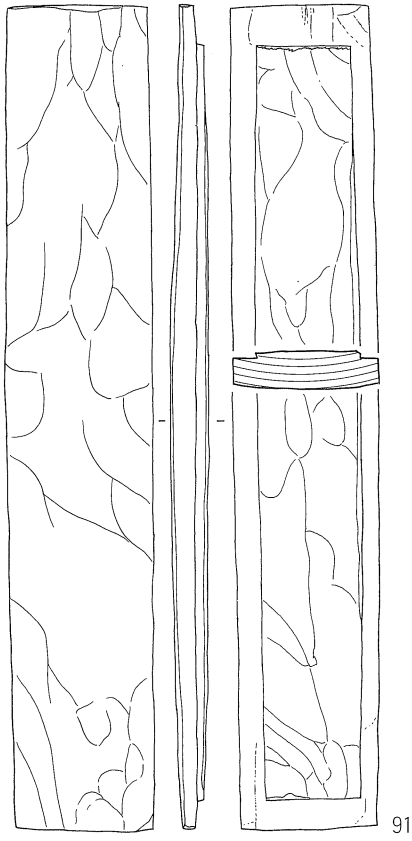

91~93 1:3

94~98 1:2

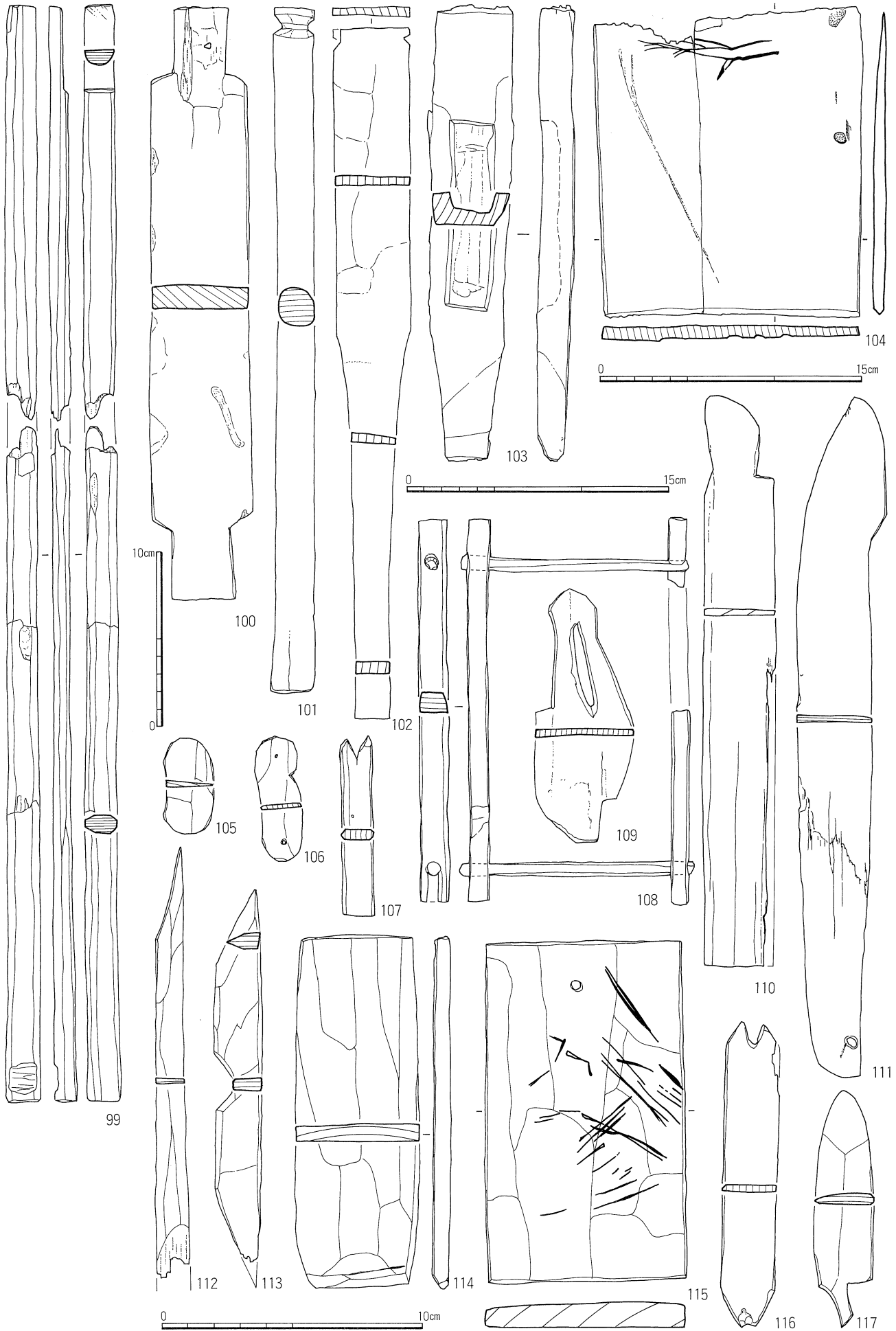

99~104 1:3

105~117 1:2

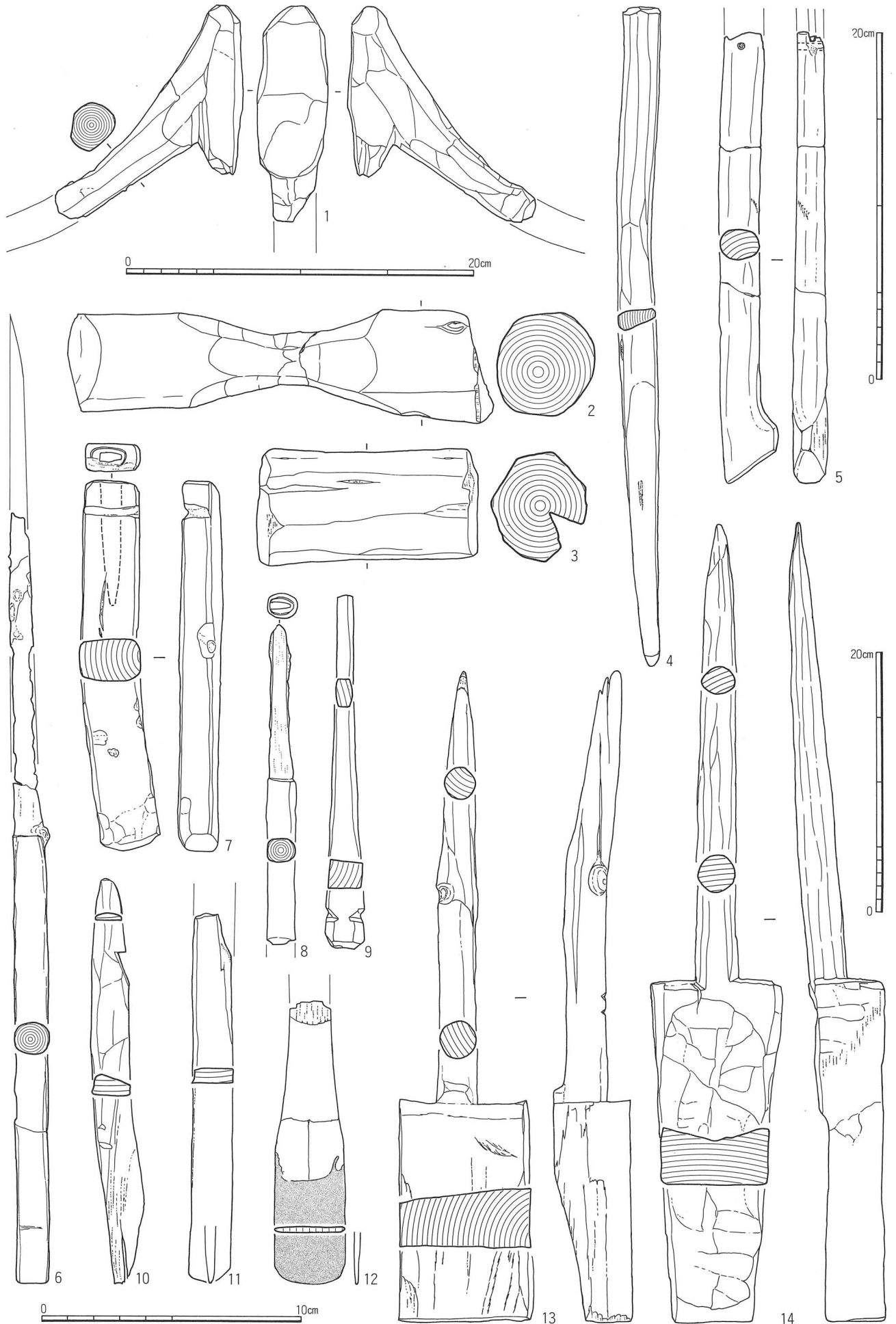

1・3・5・10・12-SD4699
14-SB5150

2-SE4770

4-SD5021

6・8-SE5220
2・3・6~12

7-SE5140

9・11-SE4225
1・4・5

13-SB4490
1・3

13・14

1: 4

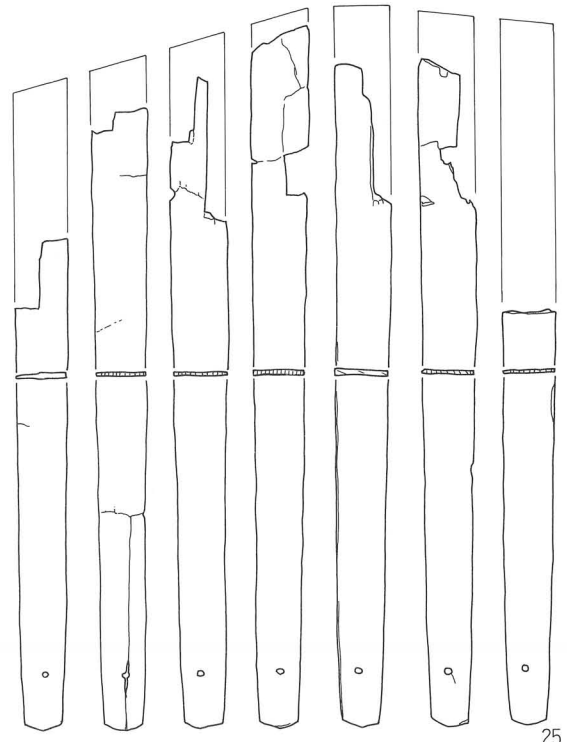
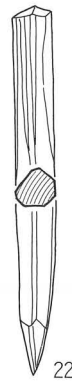
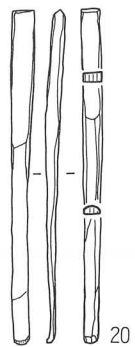
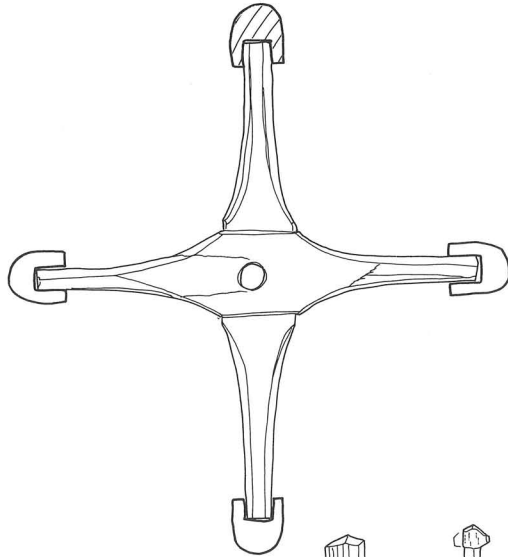
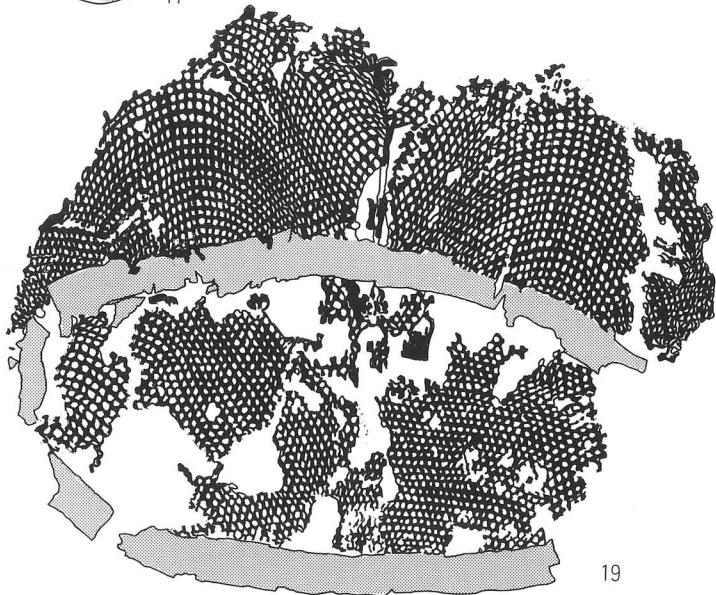
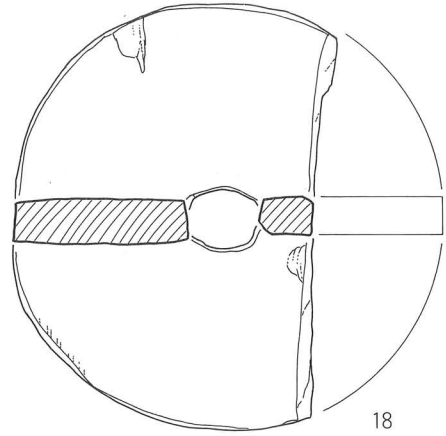
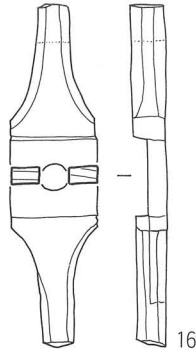
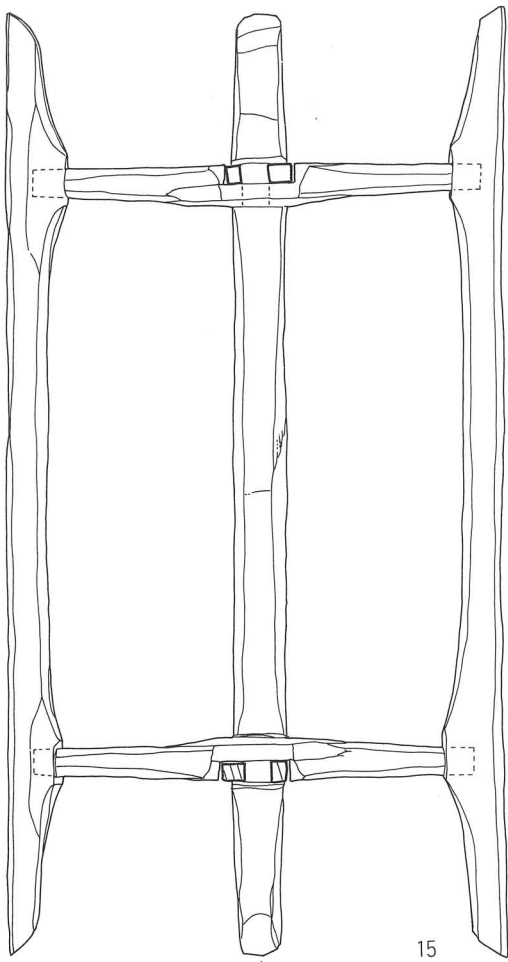

15-SE4366 16・20-SE4770 17~19・21~23-SD4699 24-SD5021 25-SE5140
 15~24 1:2 25 1:3

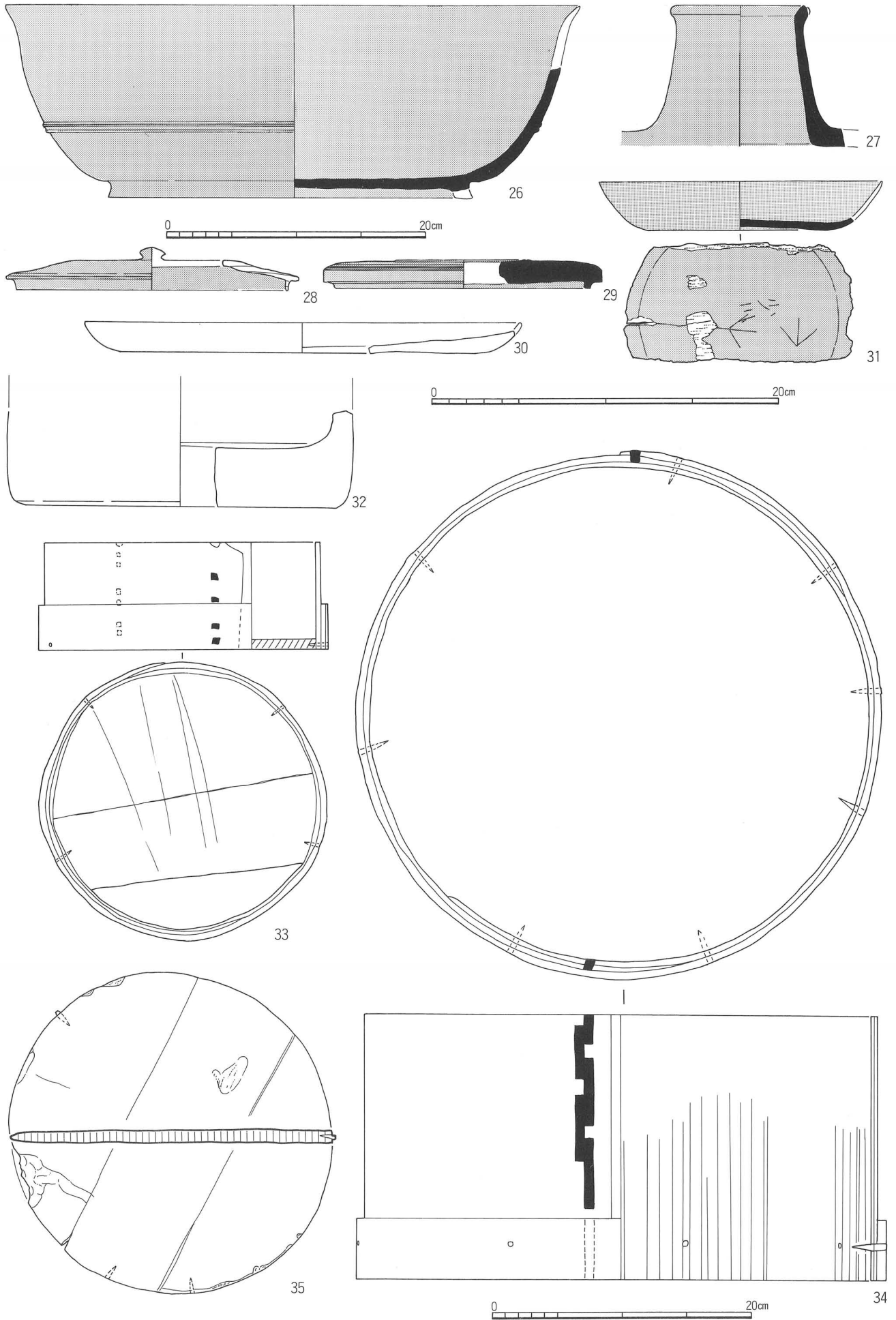

26-SB4631 27-SD4359 28~30・33-SD4699 31-SE4225 34-SE4530 35-SE4885 36-SD5021
 27~33・35 1:3 26・34 1:4

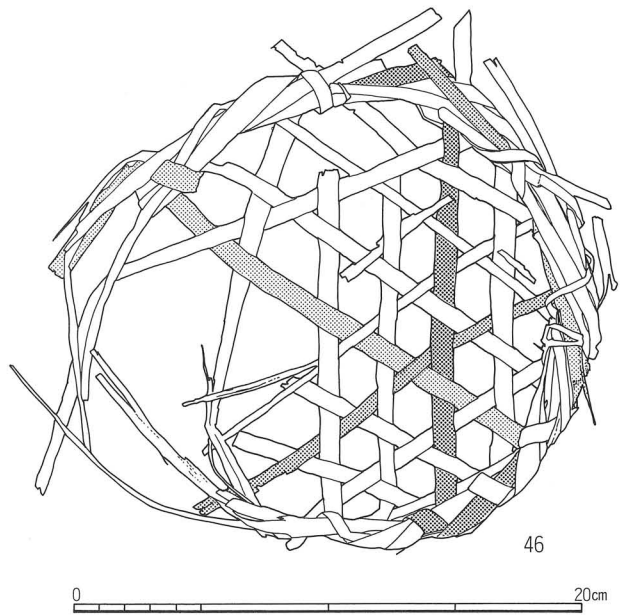
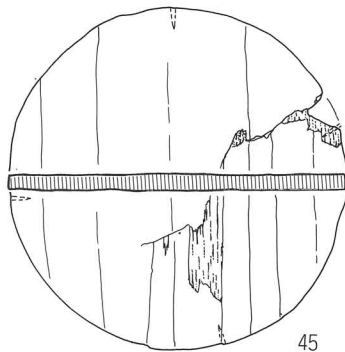
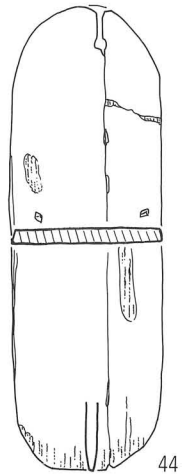
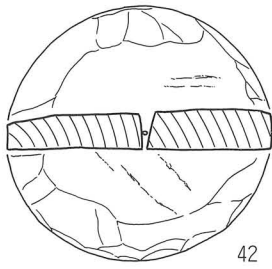
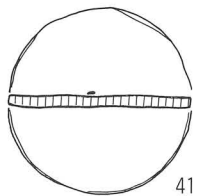
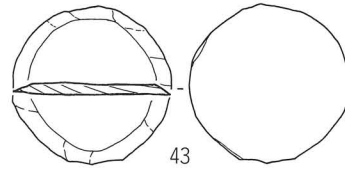
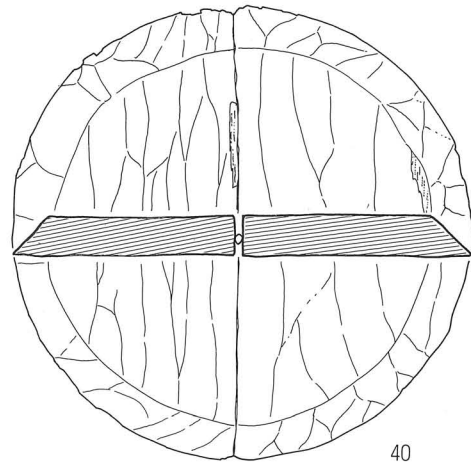
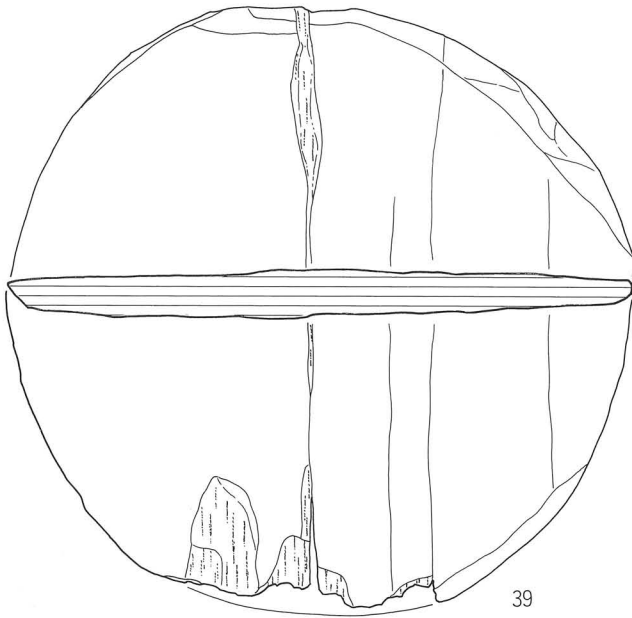
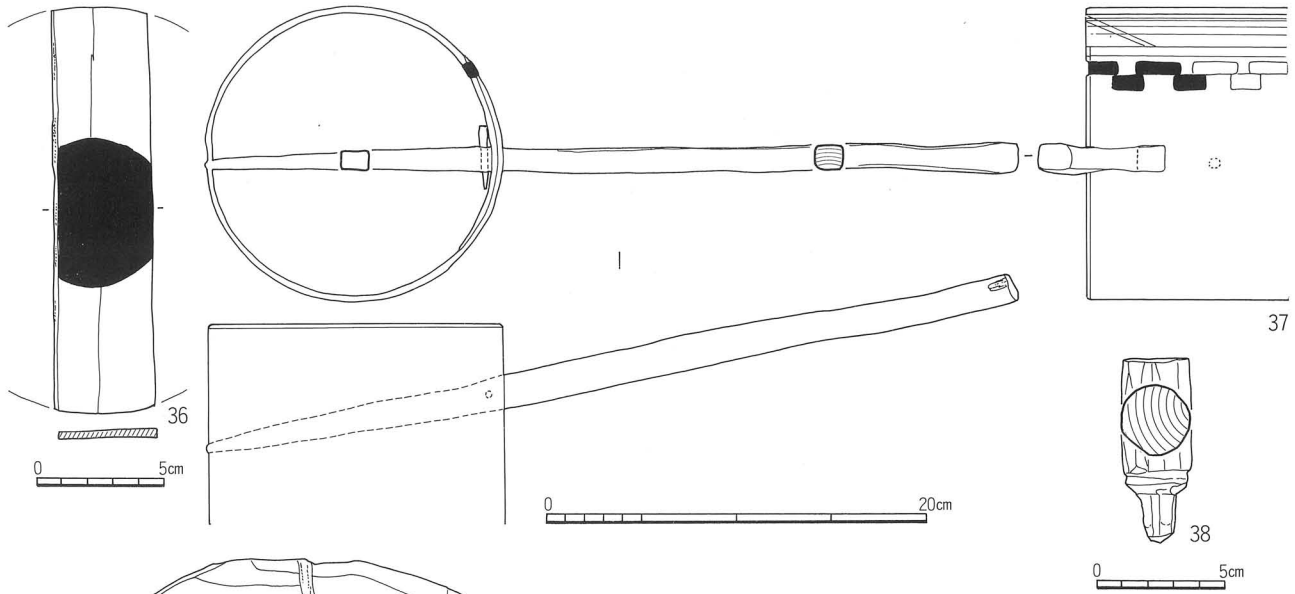

36・40・42-SD5021 37-SE4268 38・39-SD4699 41-SD4361 43・45-SE4340 44-SK5074 46-SE4815
 36・38~46 1:3 37 1:4

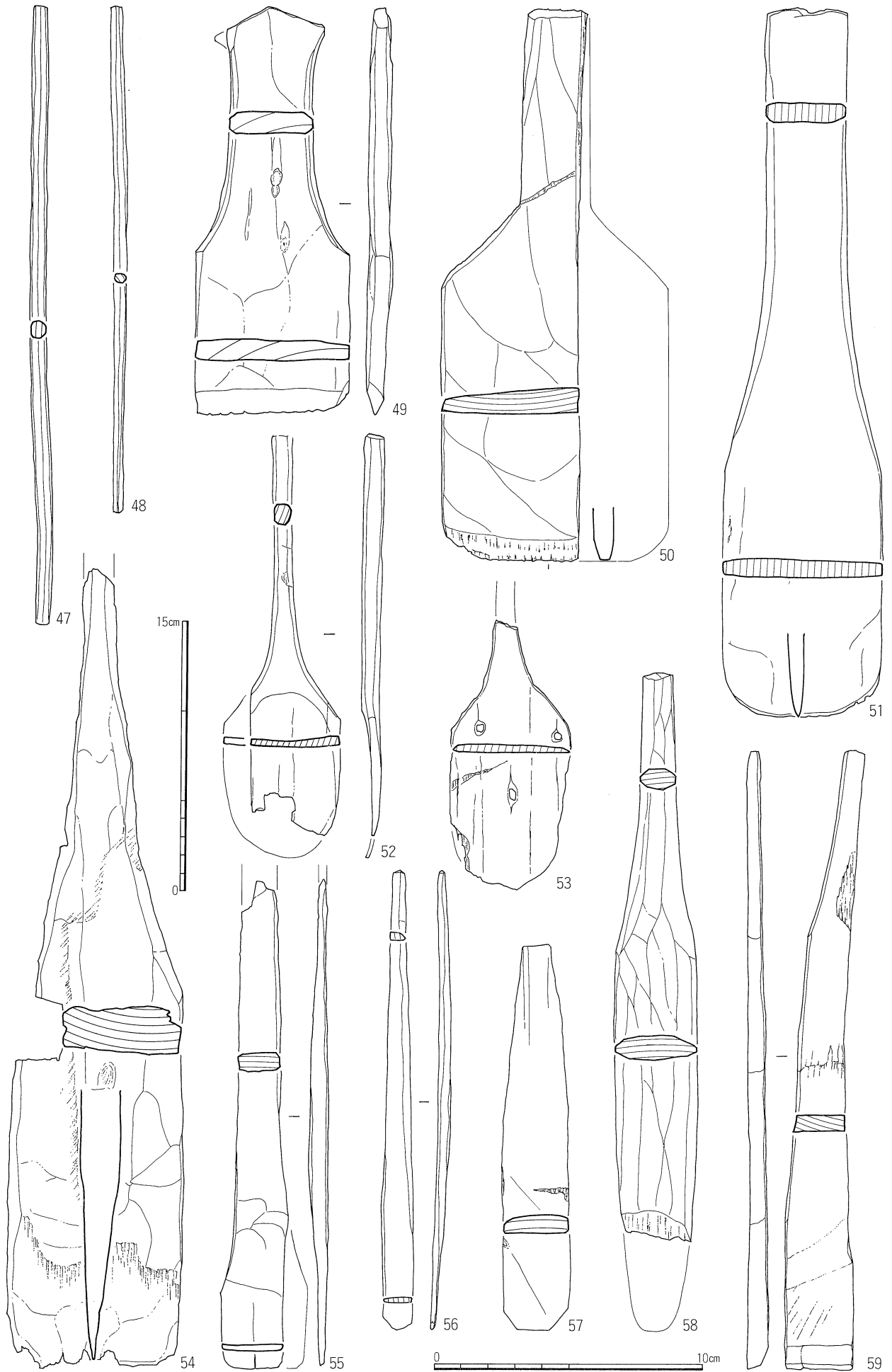

47・48-SE4225

49・50・56・57-SD4699

51・58-SD5021

52-SE5075

53-SK5074

54-SE4815

55・59-SE4770

47~53・55~59 1:2

54 1:3

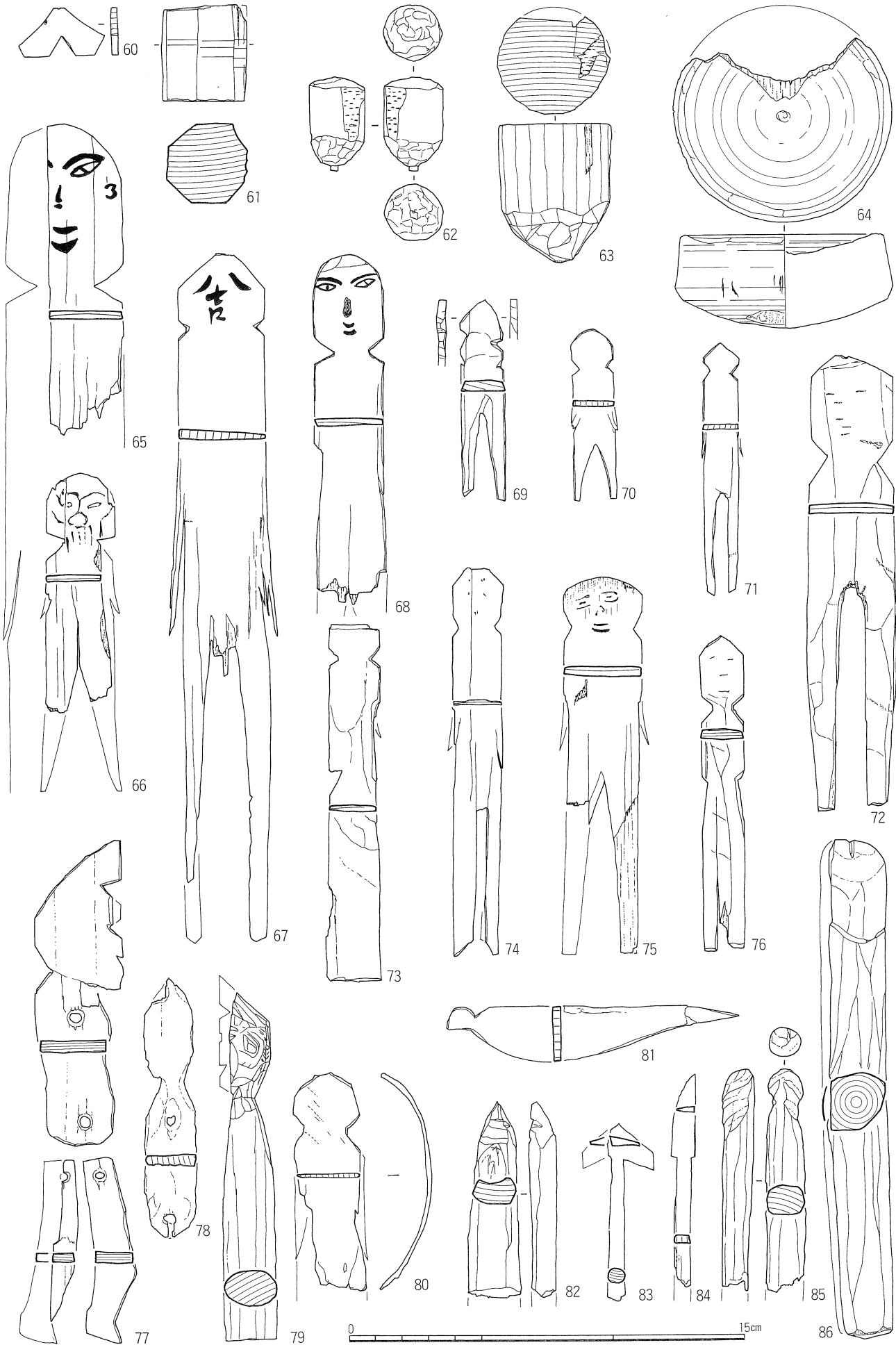

60・61・63・65~68・70~72・75・77・79・81・83・84-SD4699
80-SD4361 1 : 2

62・69・73・78・82・85-SE4770

64・76・86-SD5021

74-SE5205

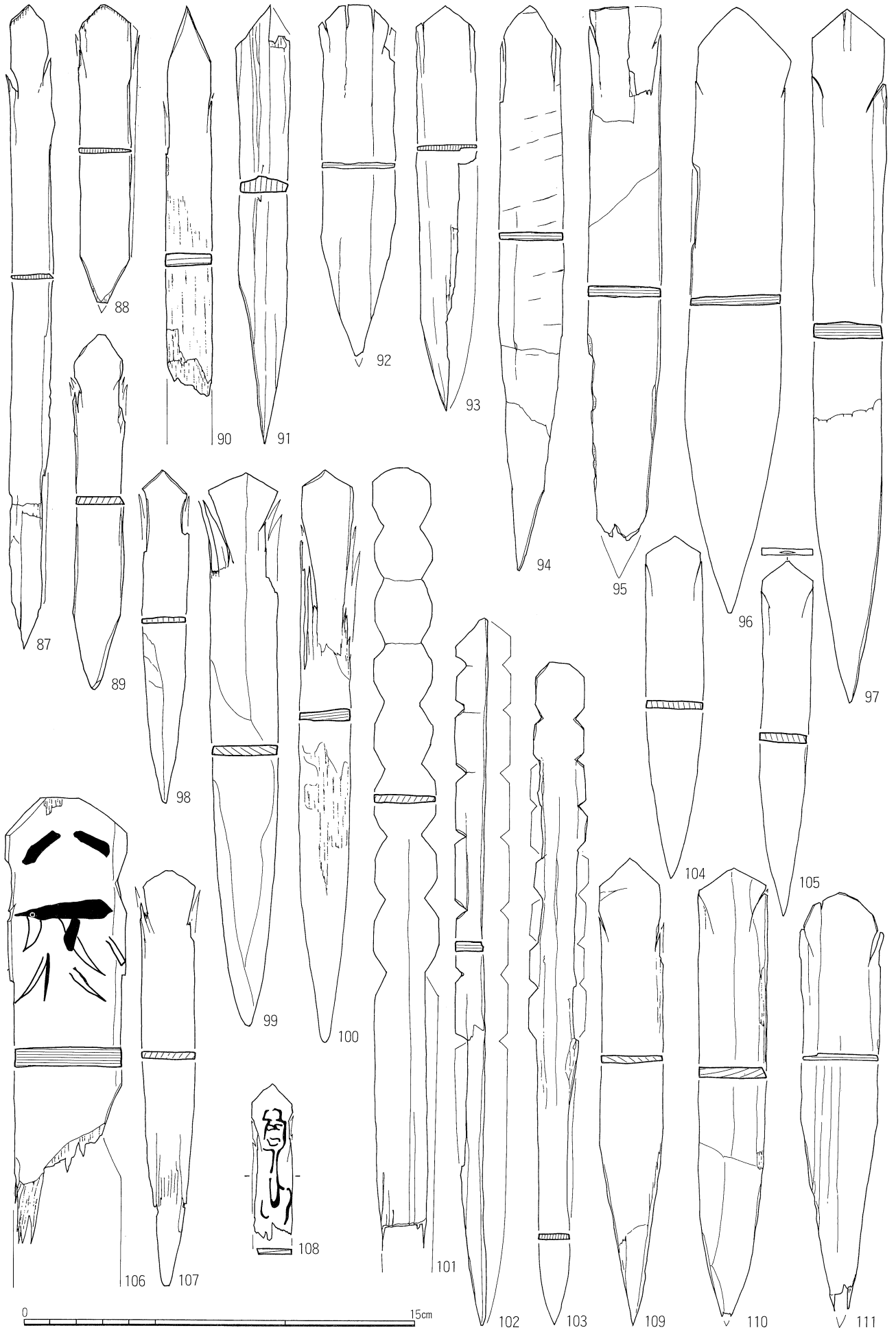

87-SE4366 88・92・93・111-SE5205 89・94・110-SE4116 90・91・97・106-SD4699 95-SE5140 96・102-SE4365
 98・99-SE4340 100-SK5199 101・107-SE4815 103-SE4380 104・105-SE4225 108-SD5021 109-SE4260

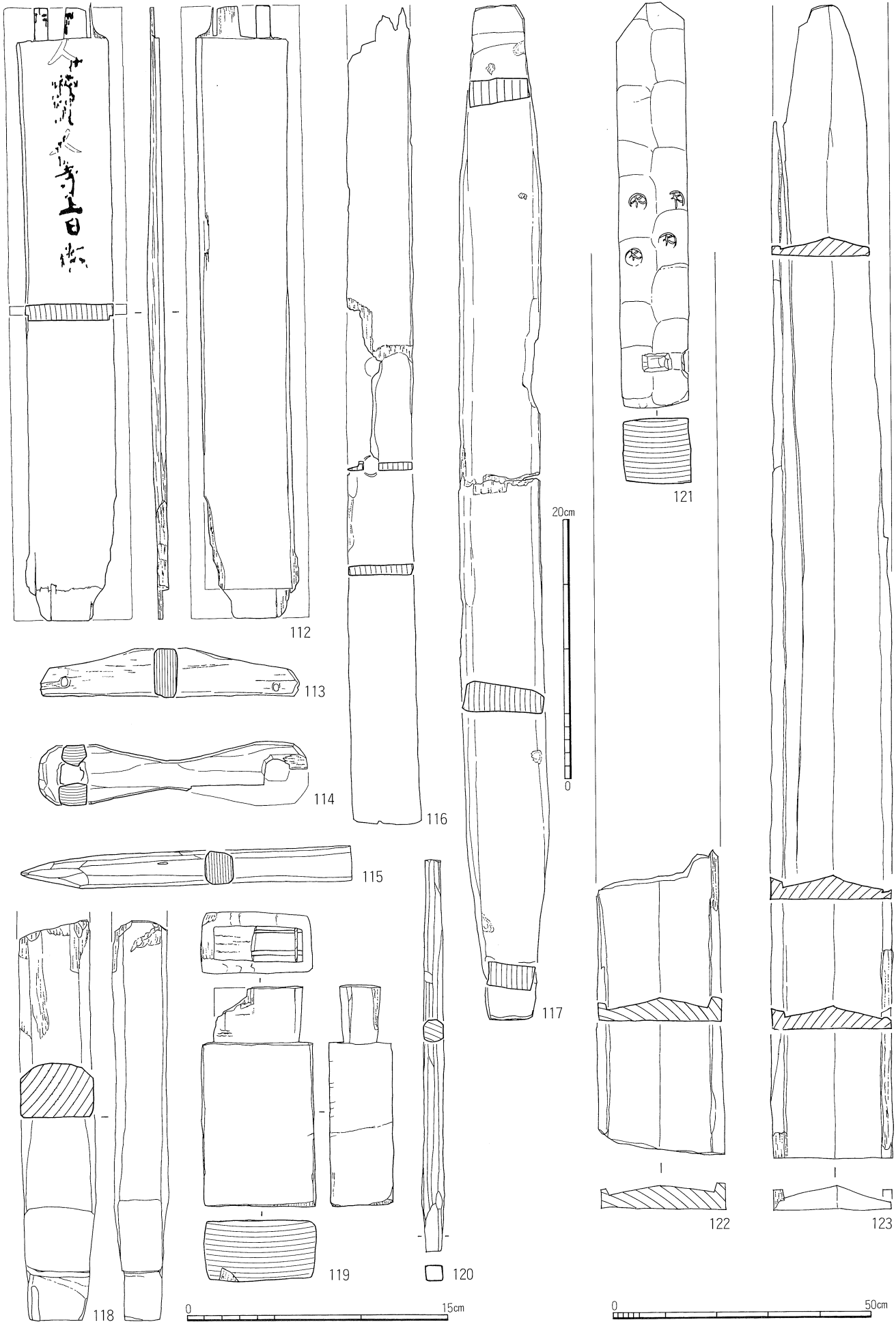

112・114・115・119-SD4699 113-SD5021 116-SE4760 117-SE4885 118-SE4705 120-SE4268 121-SB5250
 122-SD5034 123-SE4116 112~116・118~120 1:3 117 1:4 121~123 1:10

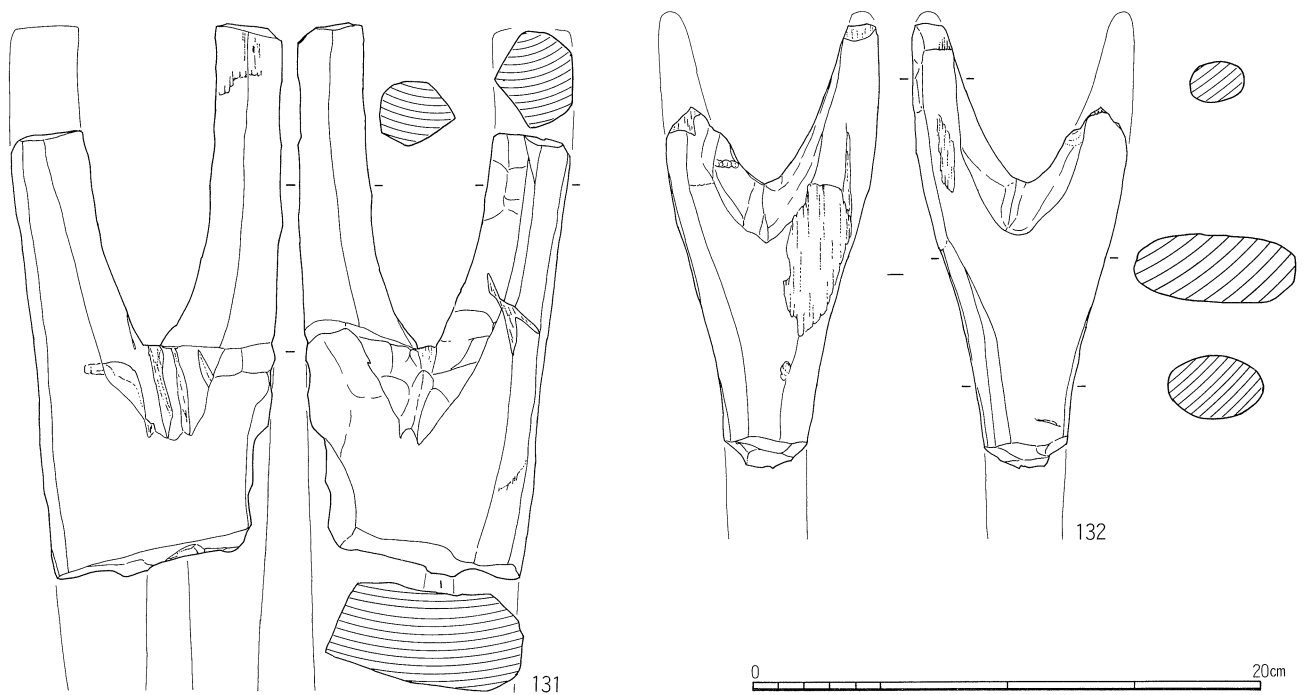
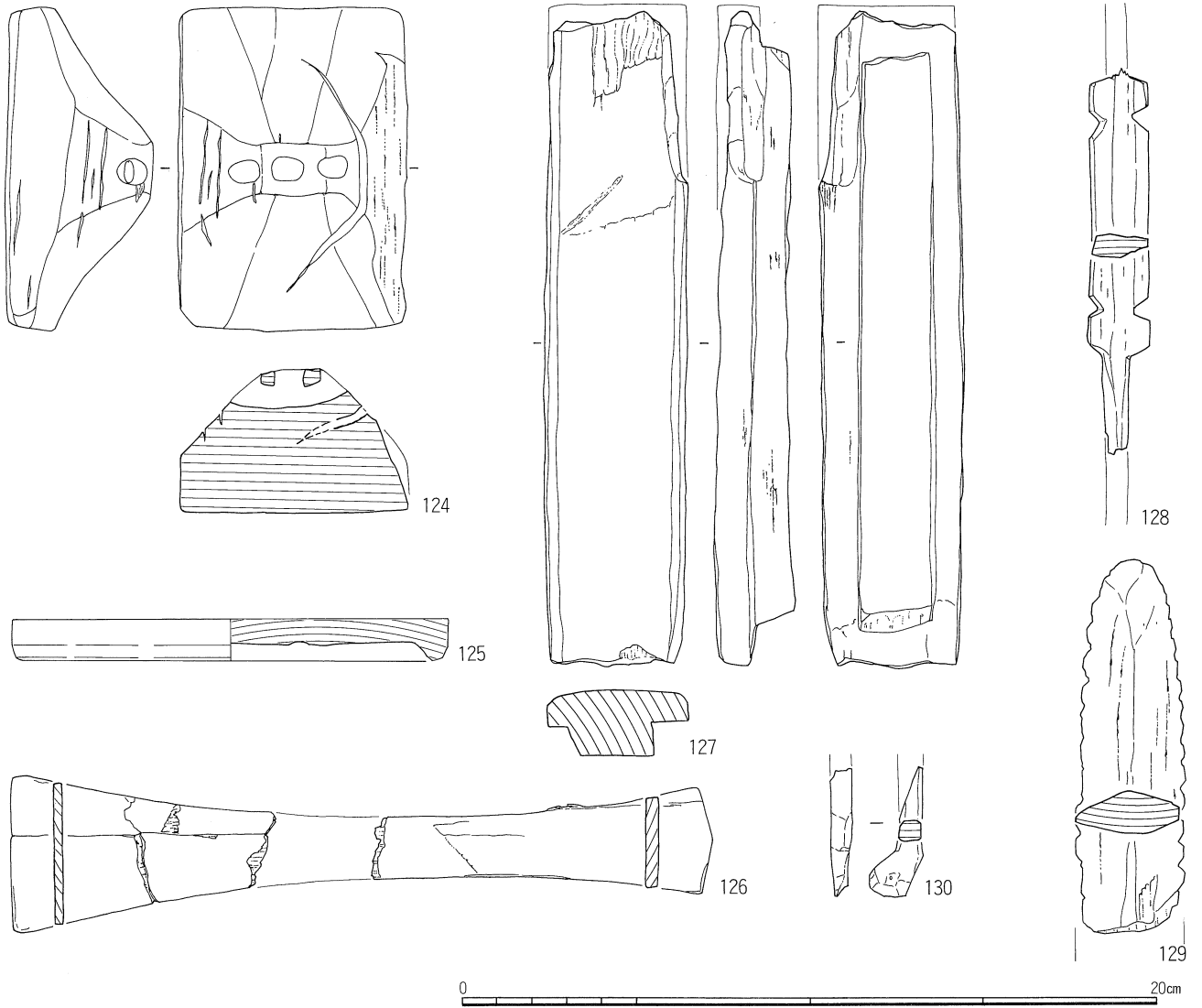

124・126-SD4699

125・128・129-SD5021

130-SE4770

131-SE4145

124~129 1:2

131・132 1:3

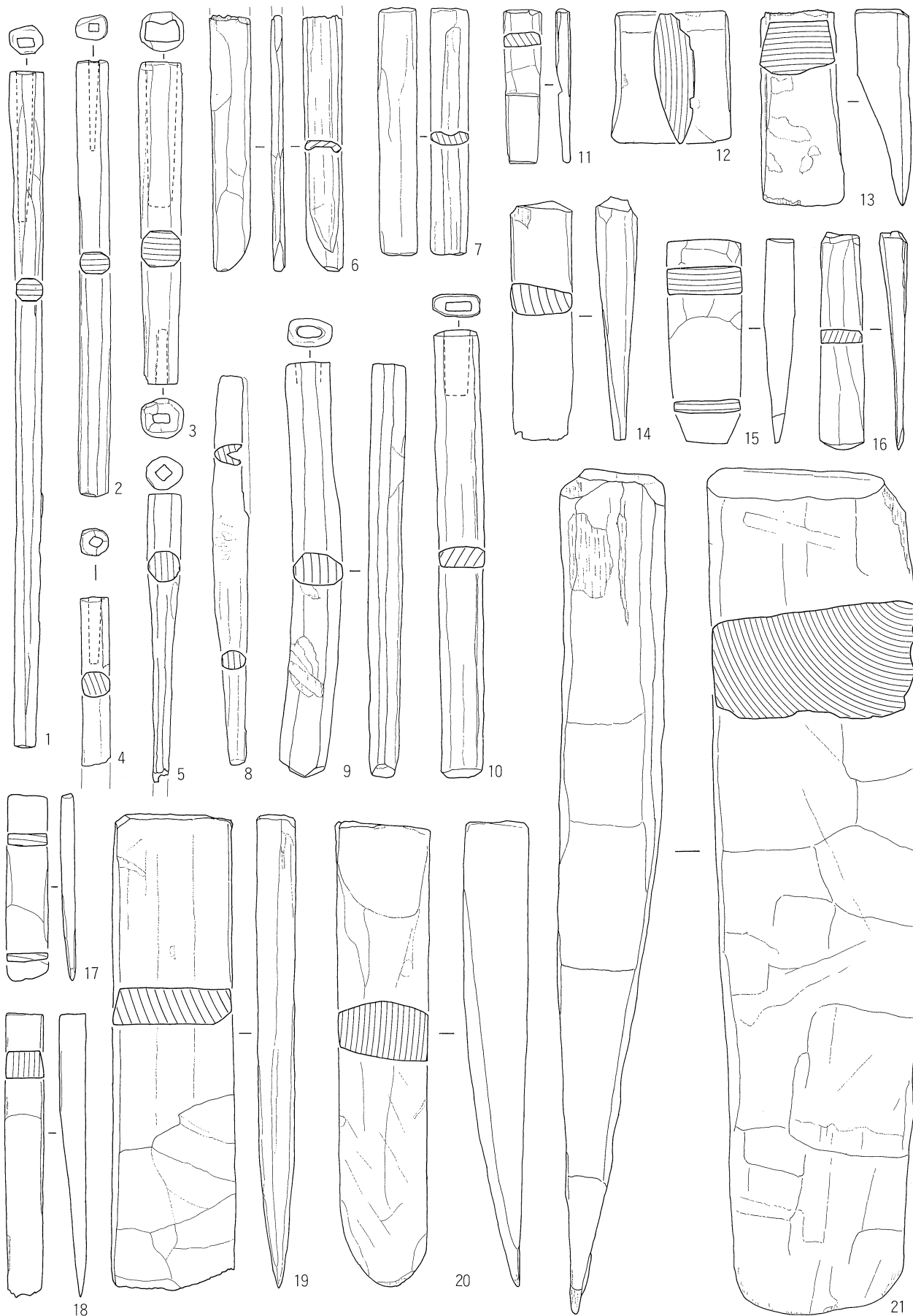

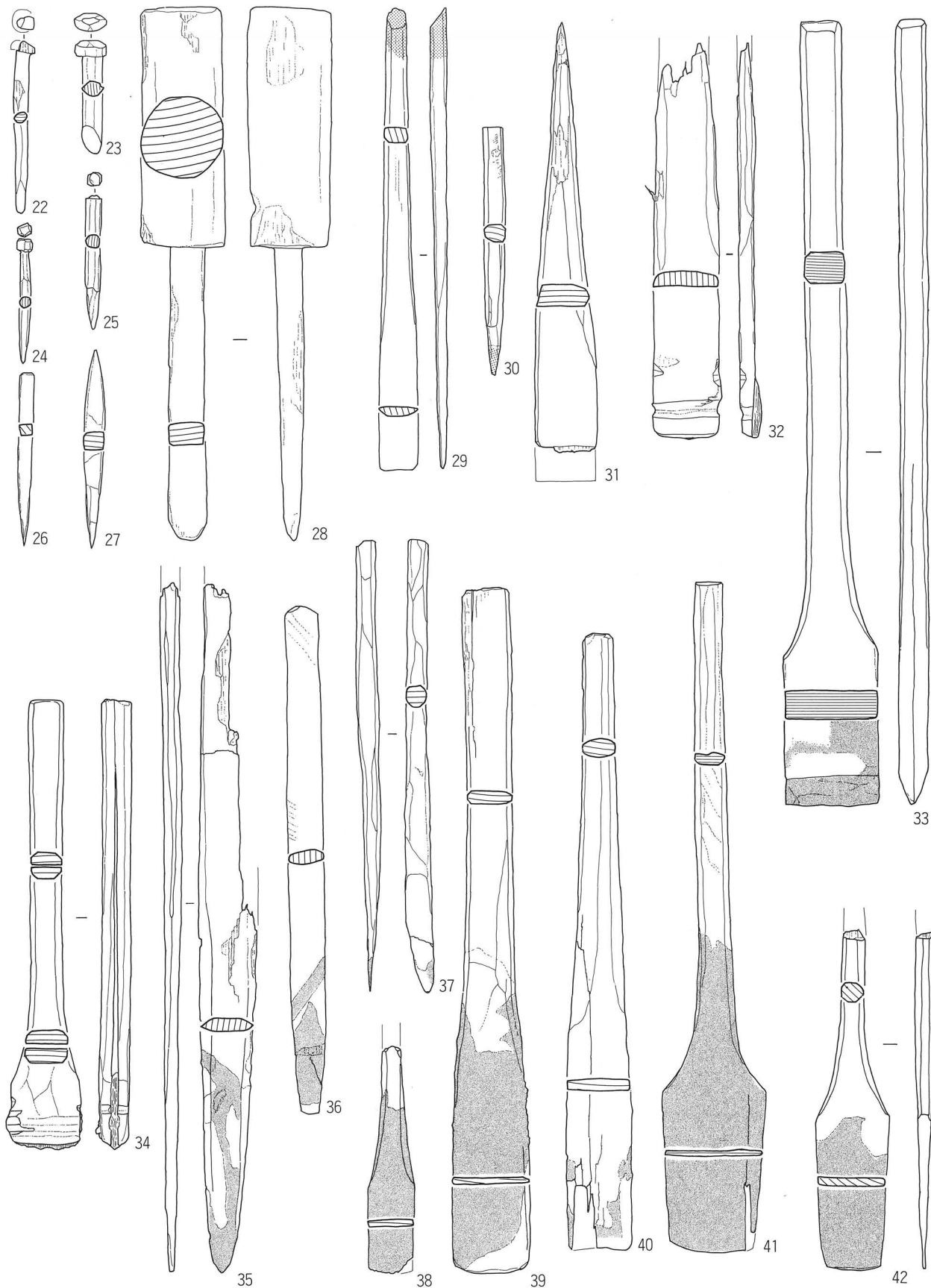

0 20cm

1:2

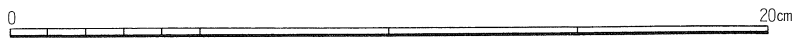
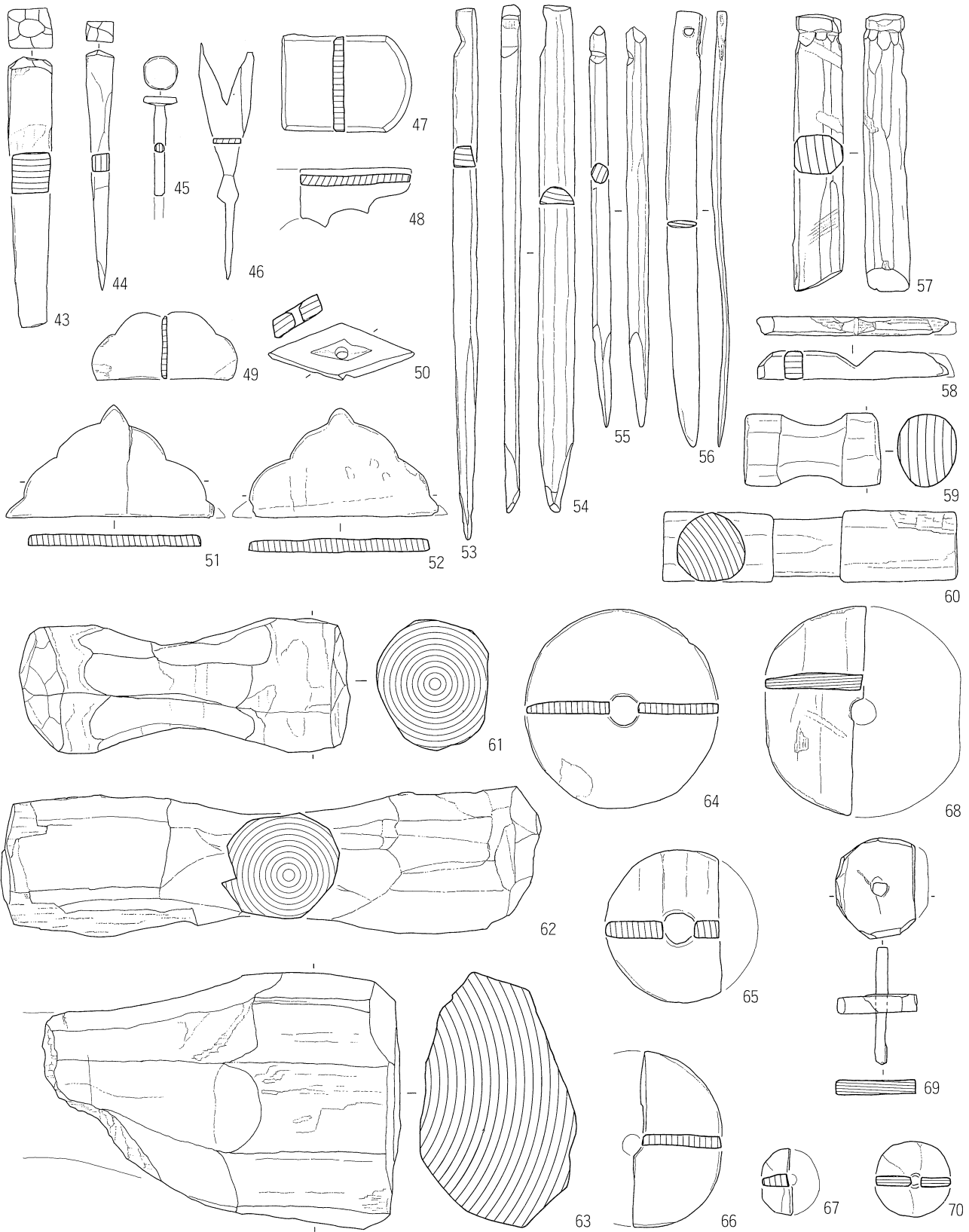

1:2

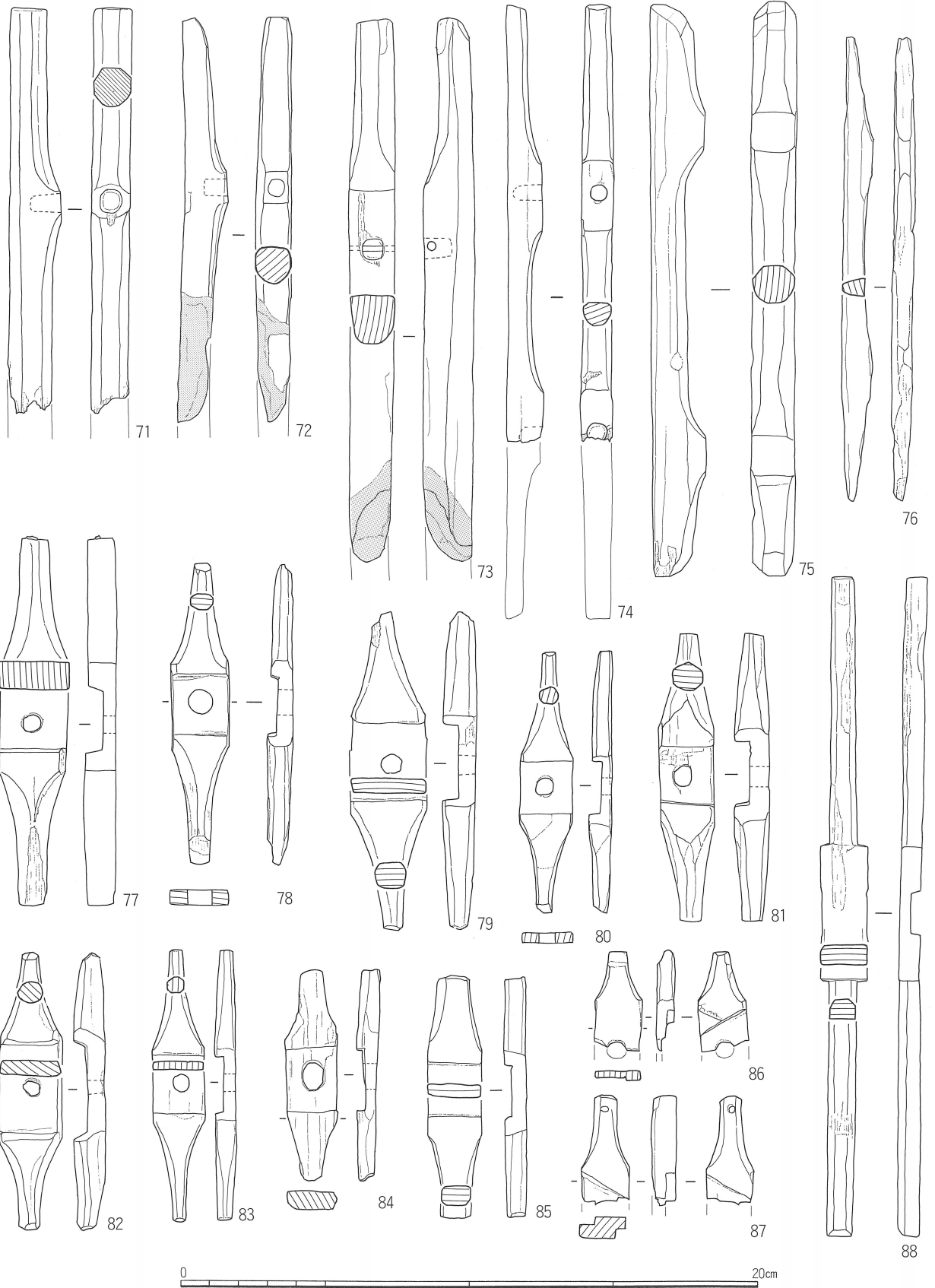

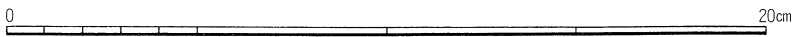
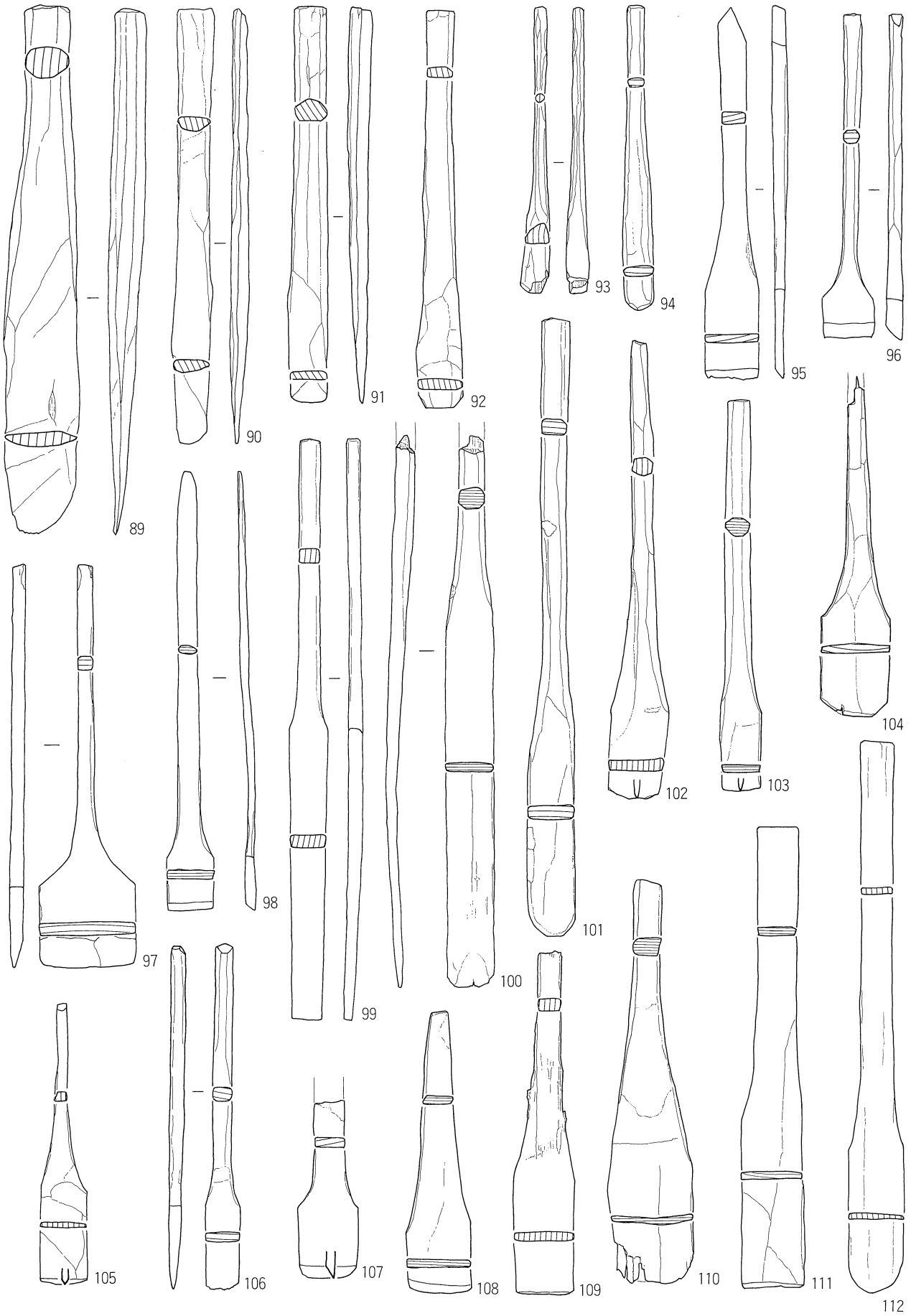

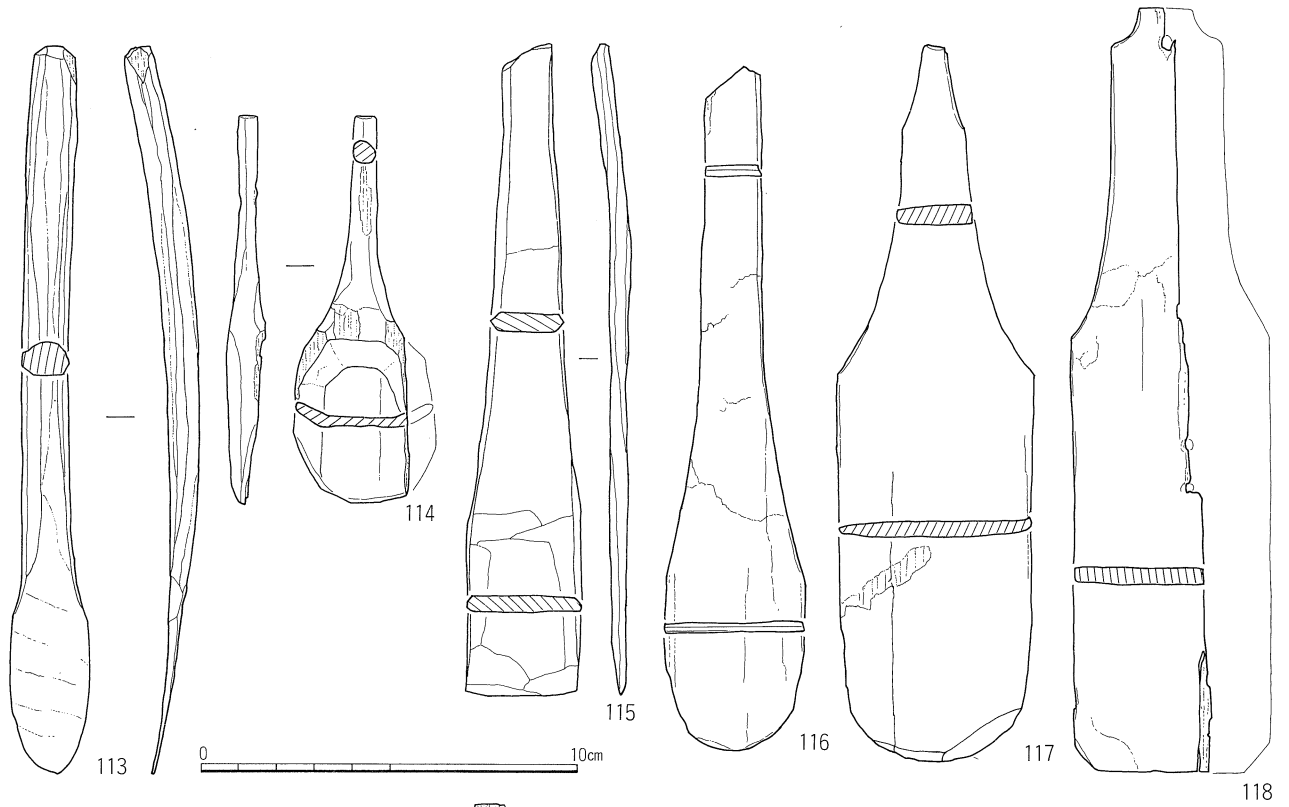

113~118 1:2

119~125 1:4

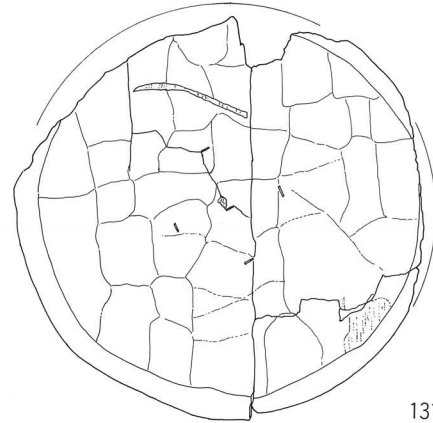
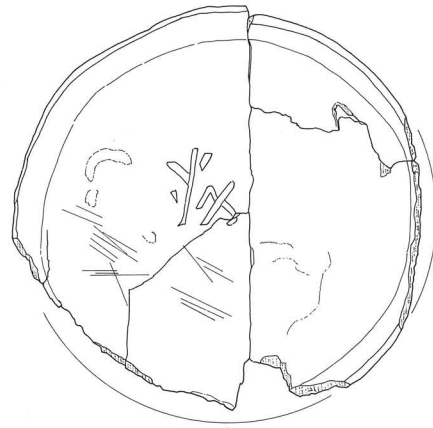
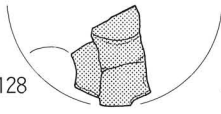
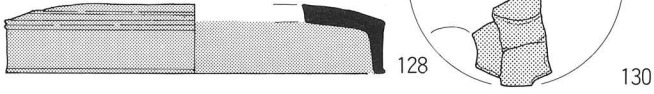
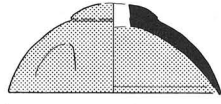
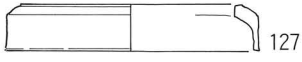
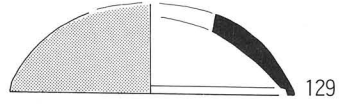
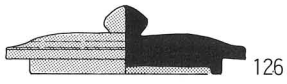

131

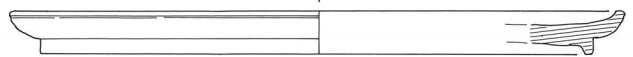
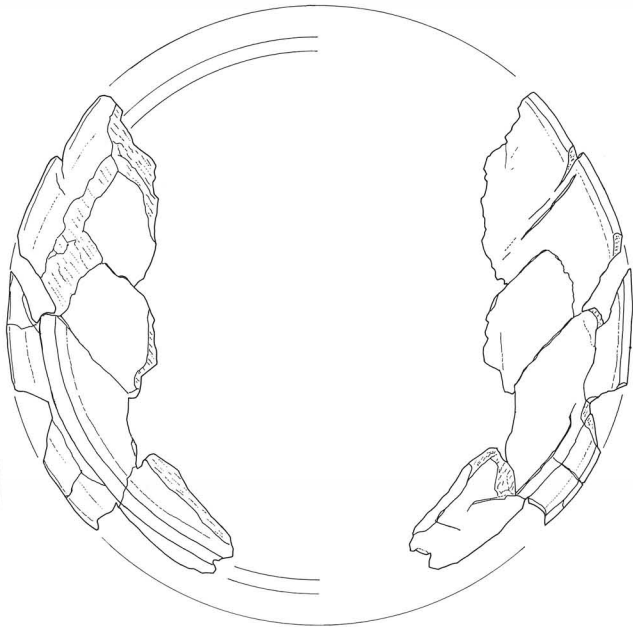
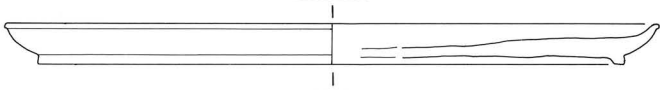

133

132



1:4

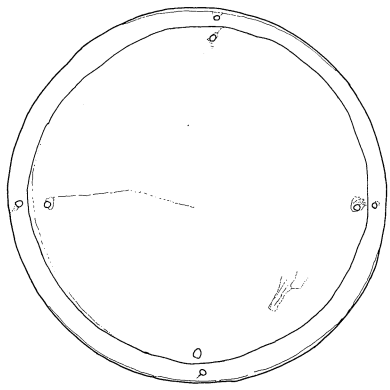

134

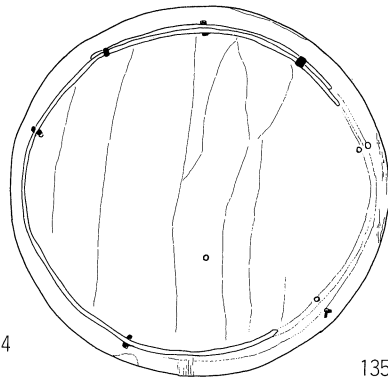

135

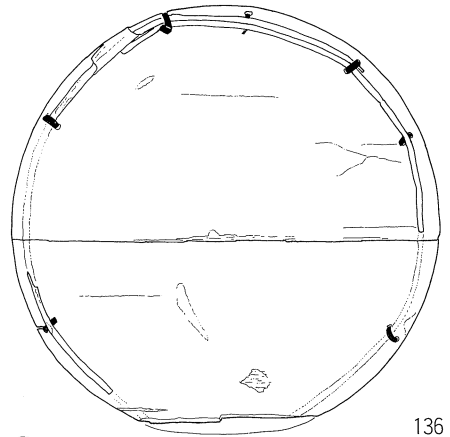

136

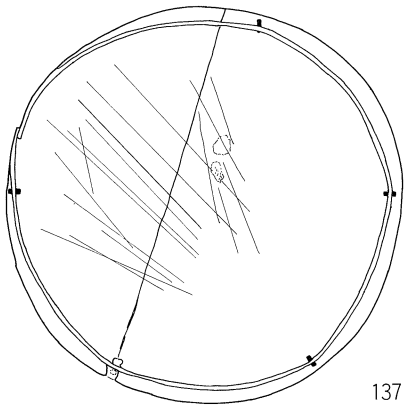
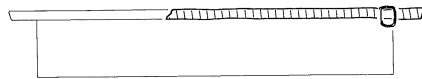
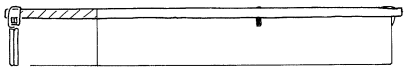

137

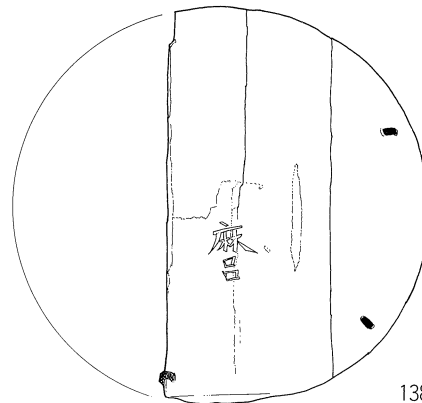

138

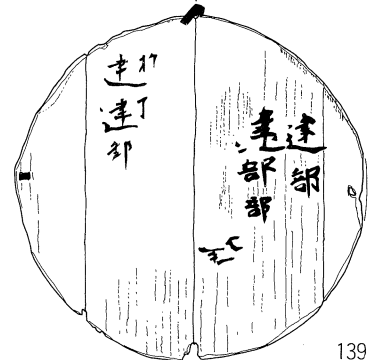
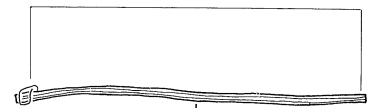

139

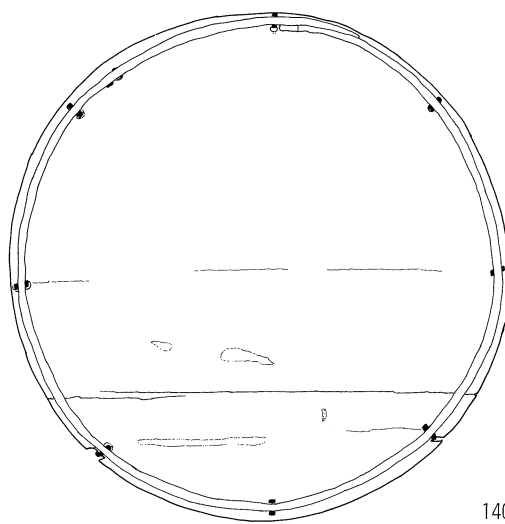
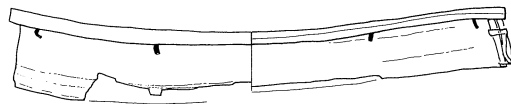
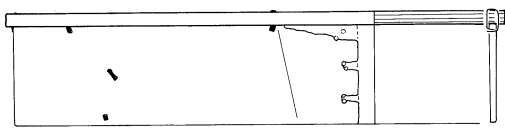

140

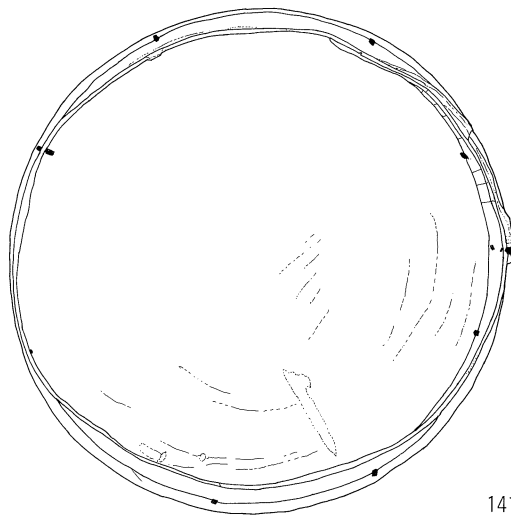

141

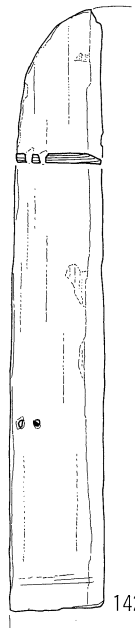

142

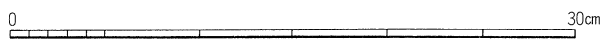

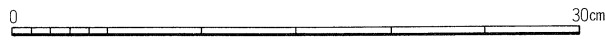
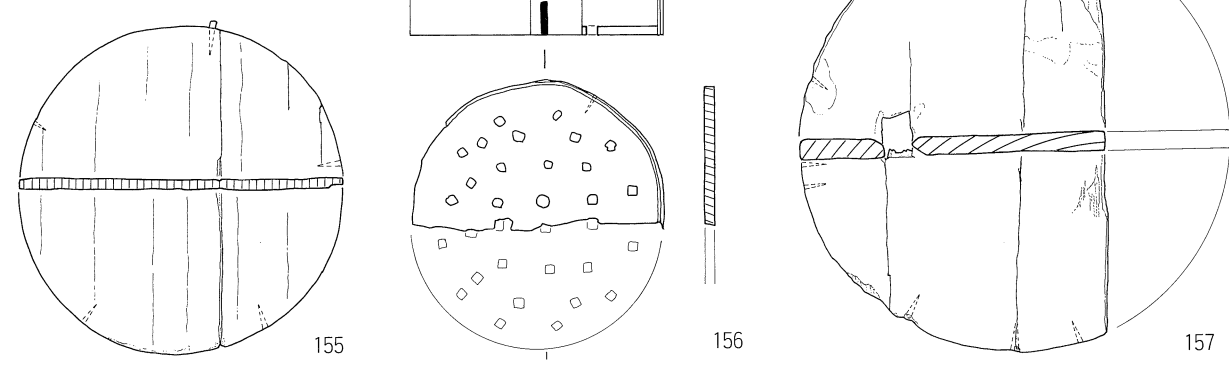
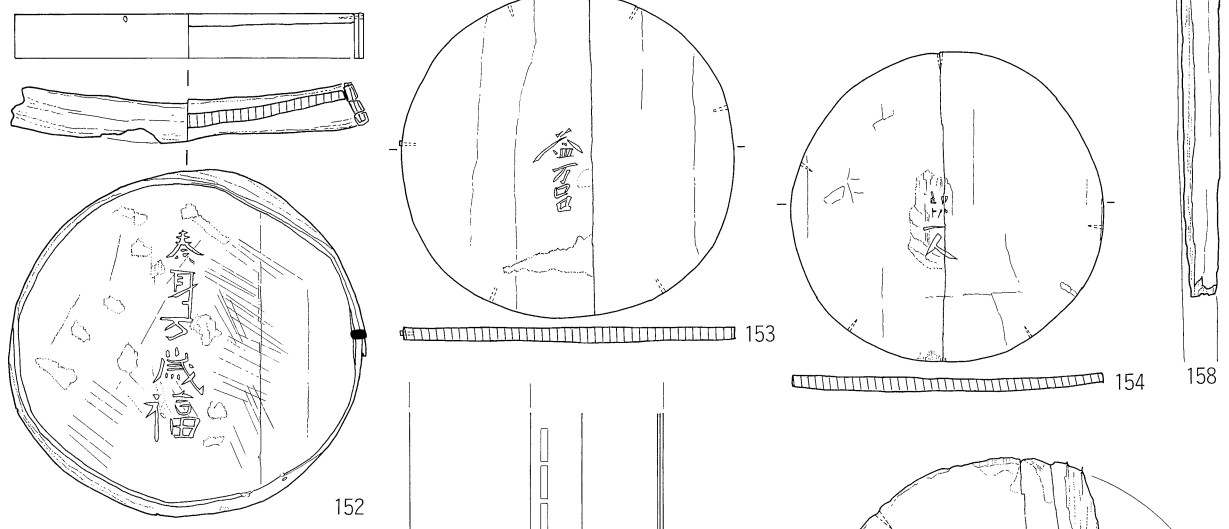
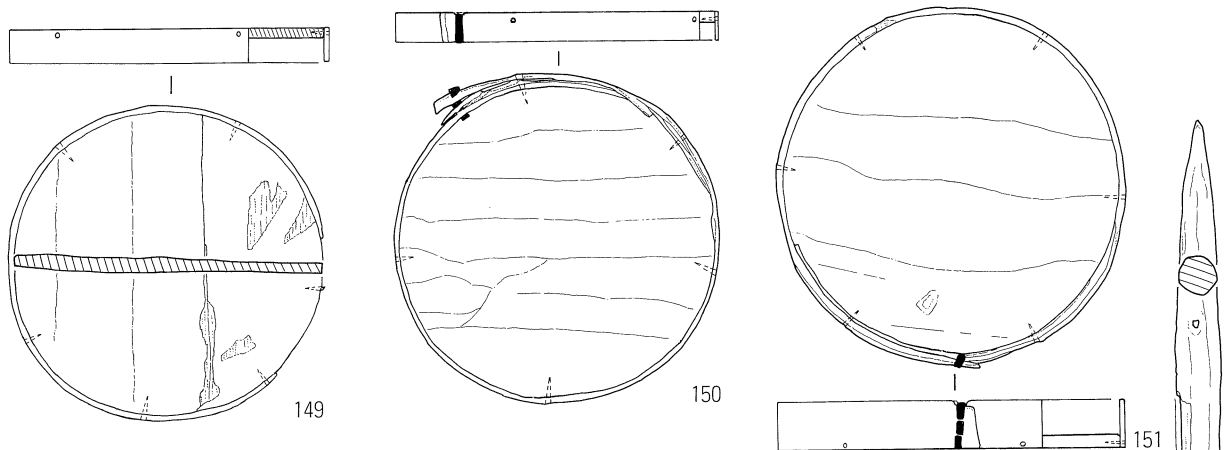
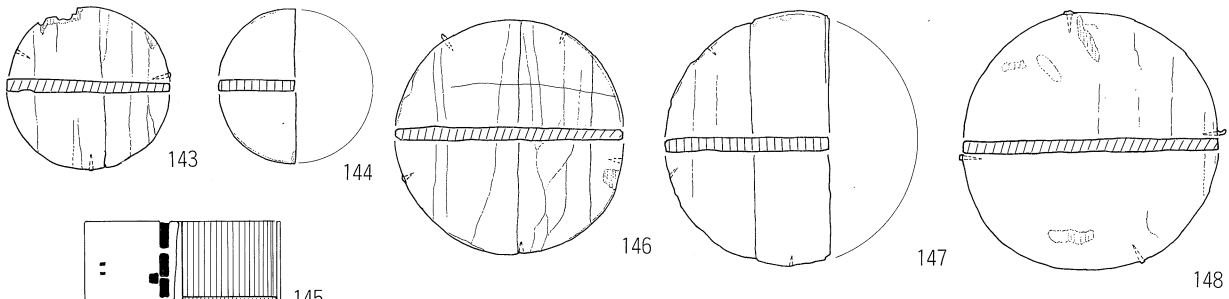

1:4

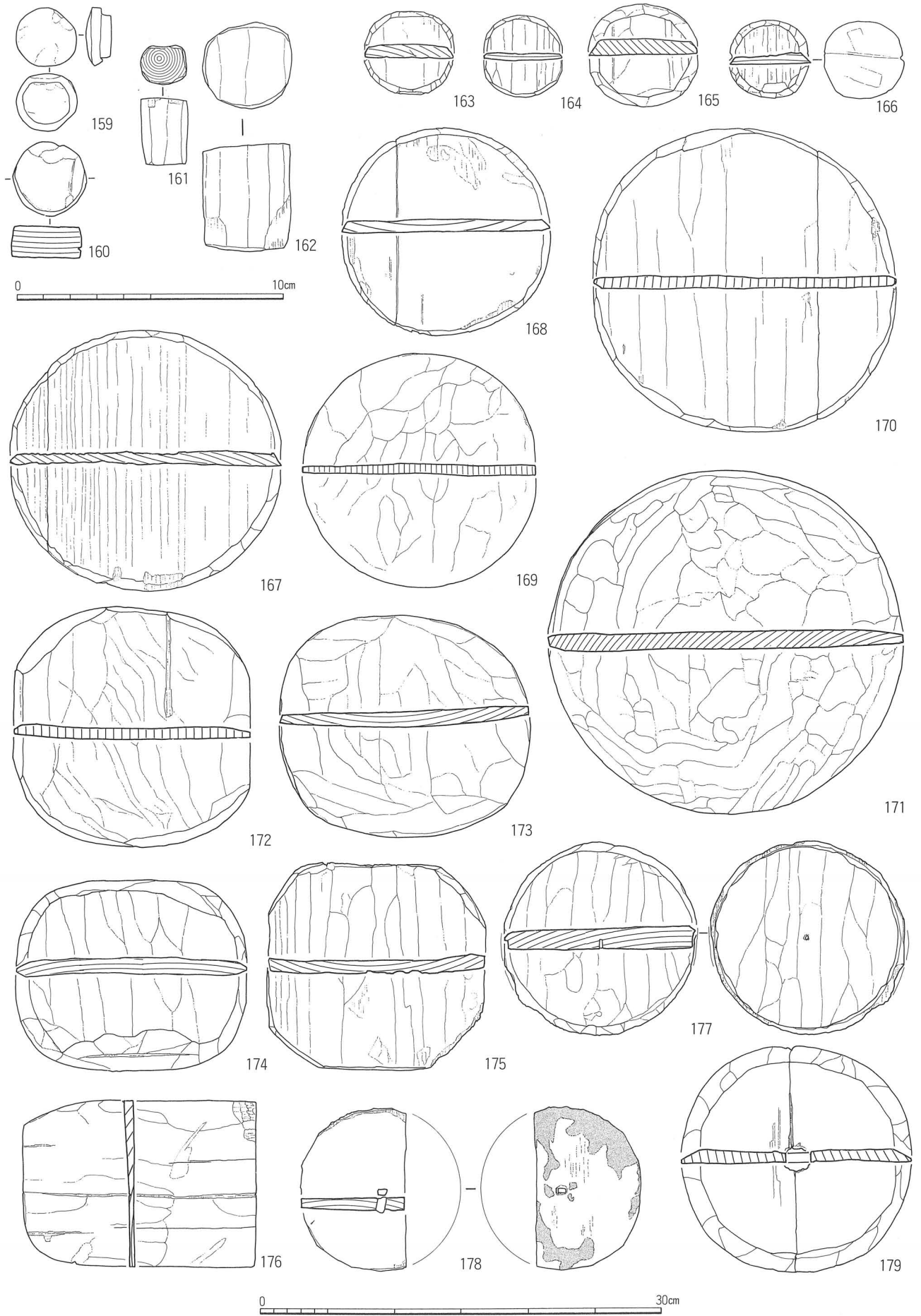

159~162 1 : 2

163~179 1 : 4

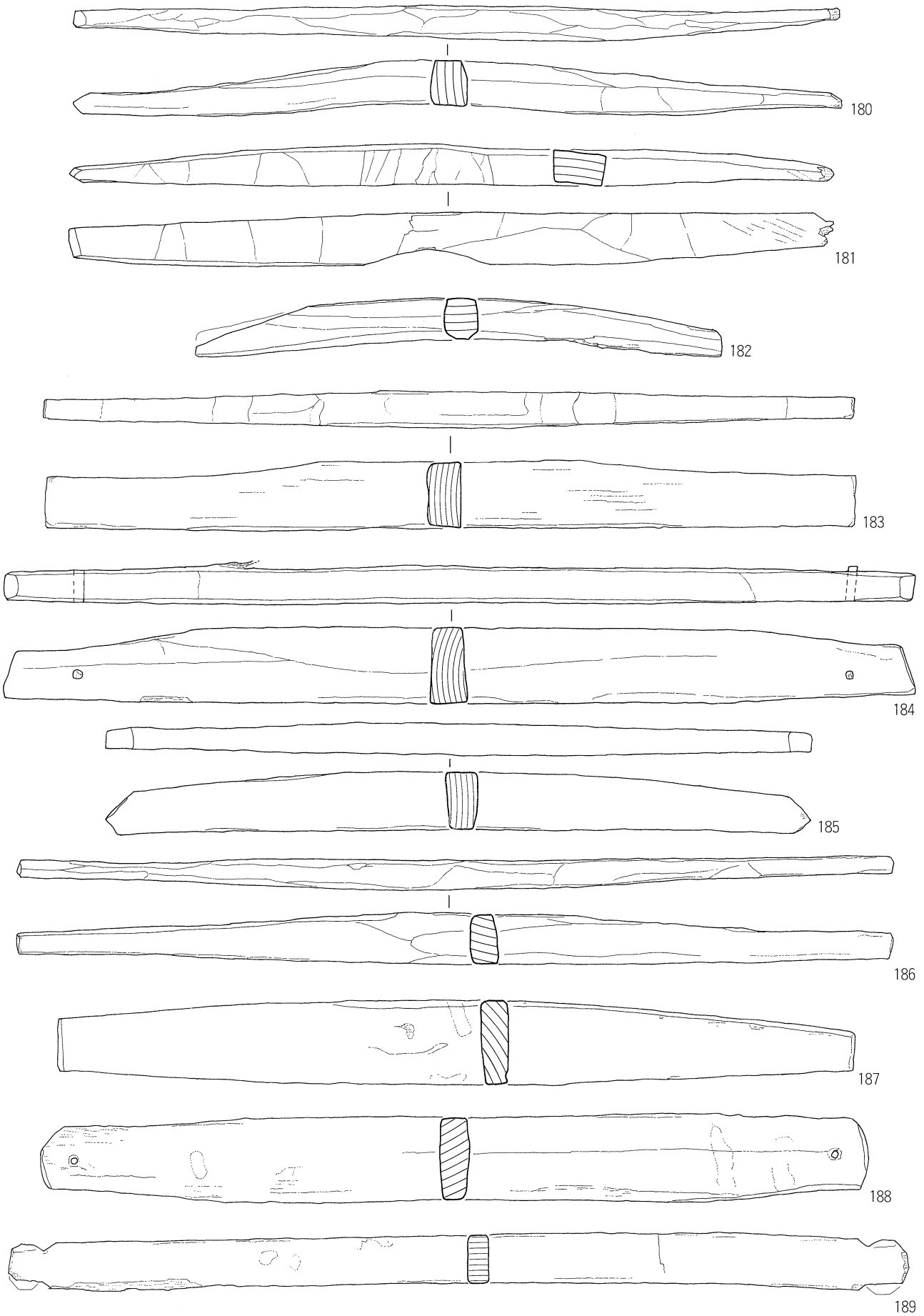

0 20cm

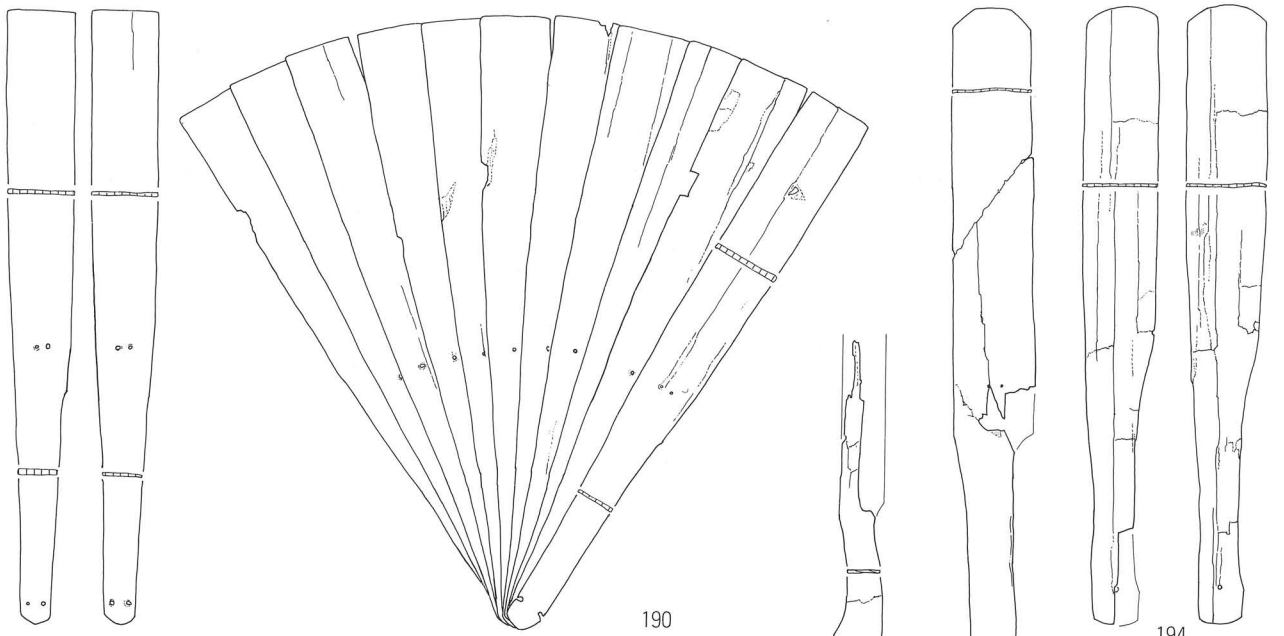

190

192

193

194

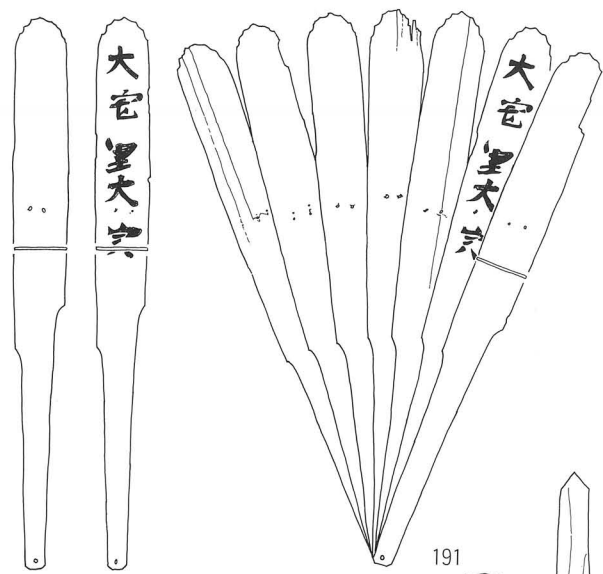

191

195

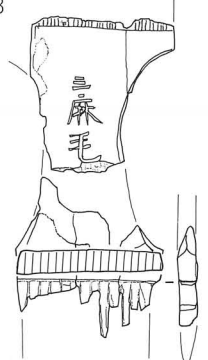

199

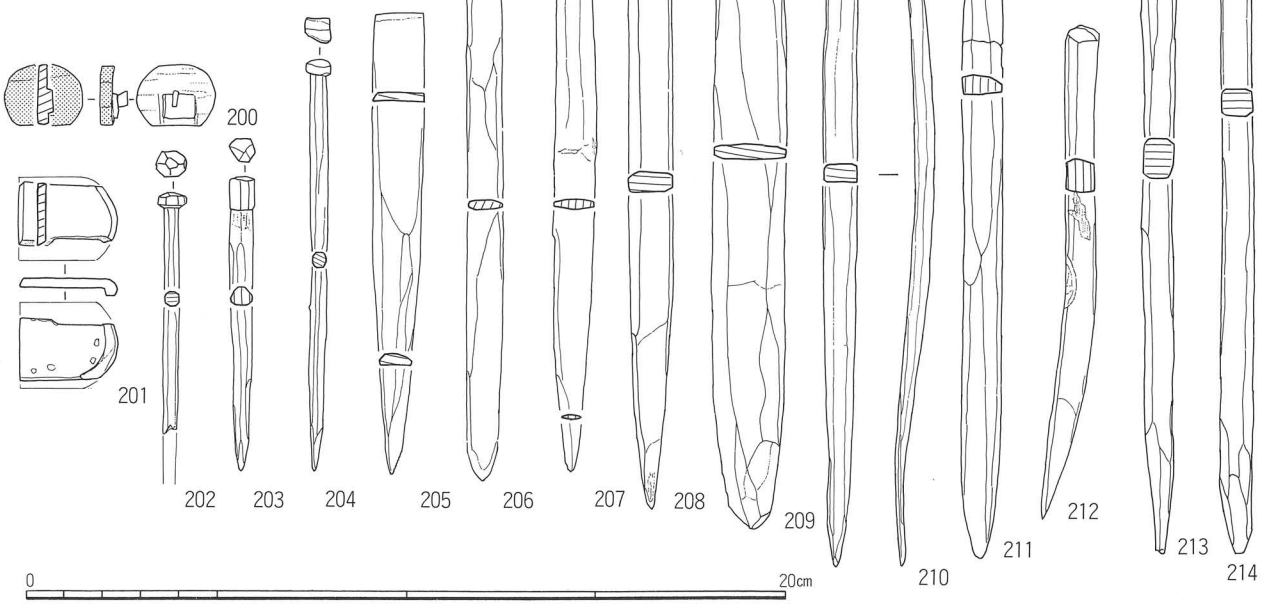

200

201

202

203

204

205

206

207

208

209

210

211

212

213

214

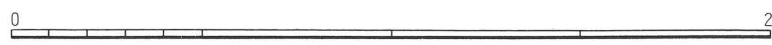

190~199 1 : 4

200~214 1 : 2

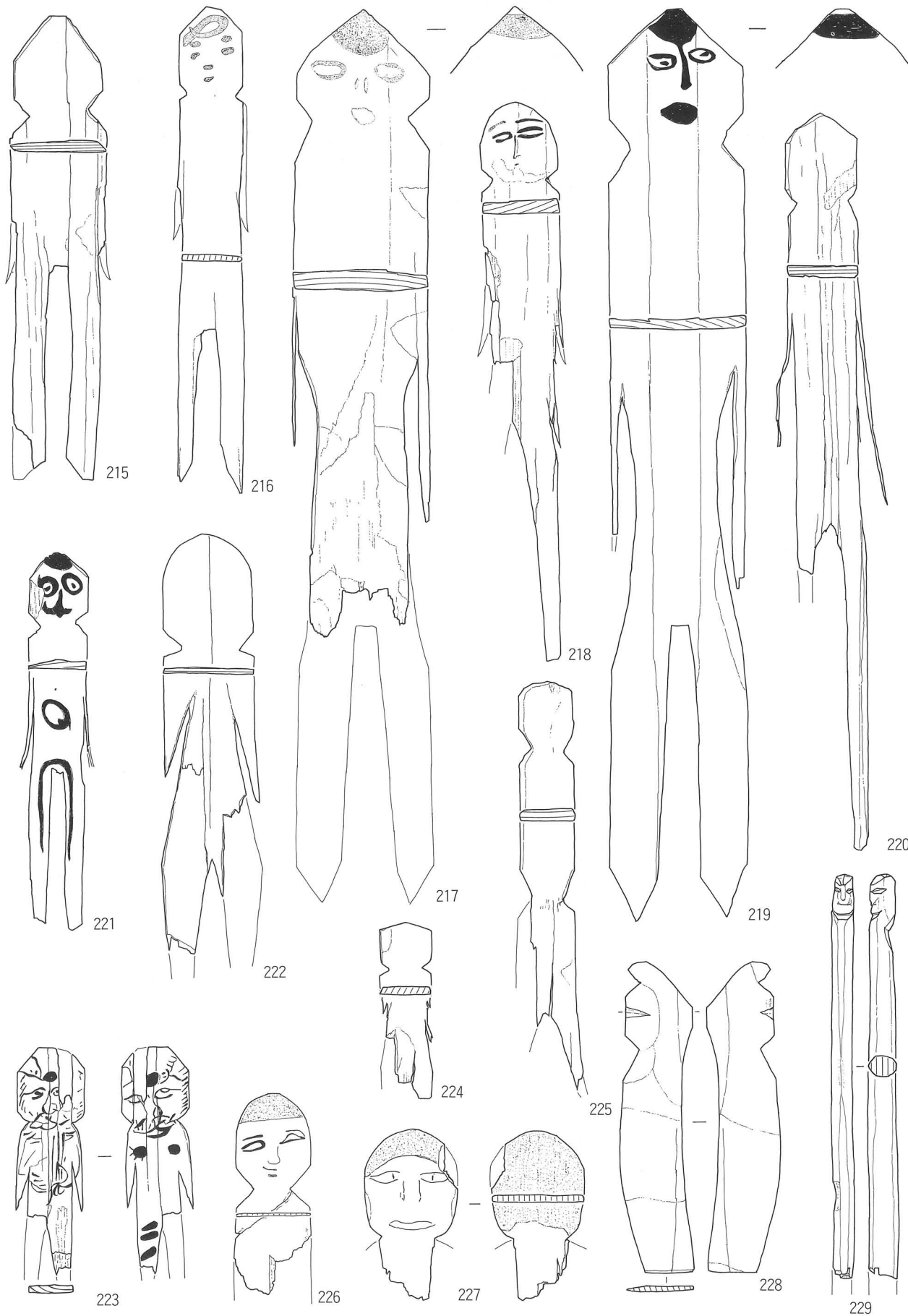

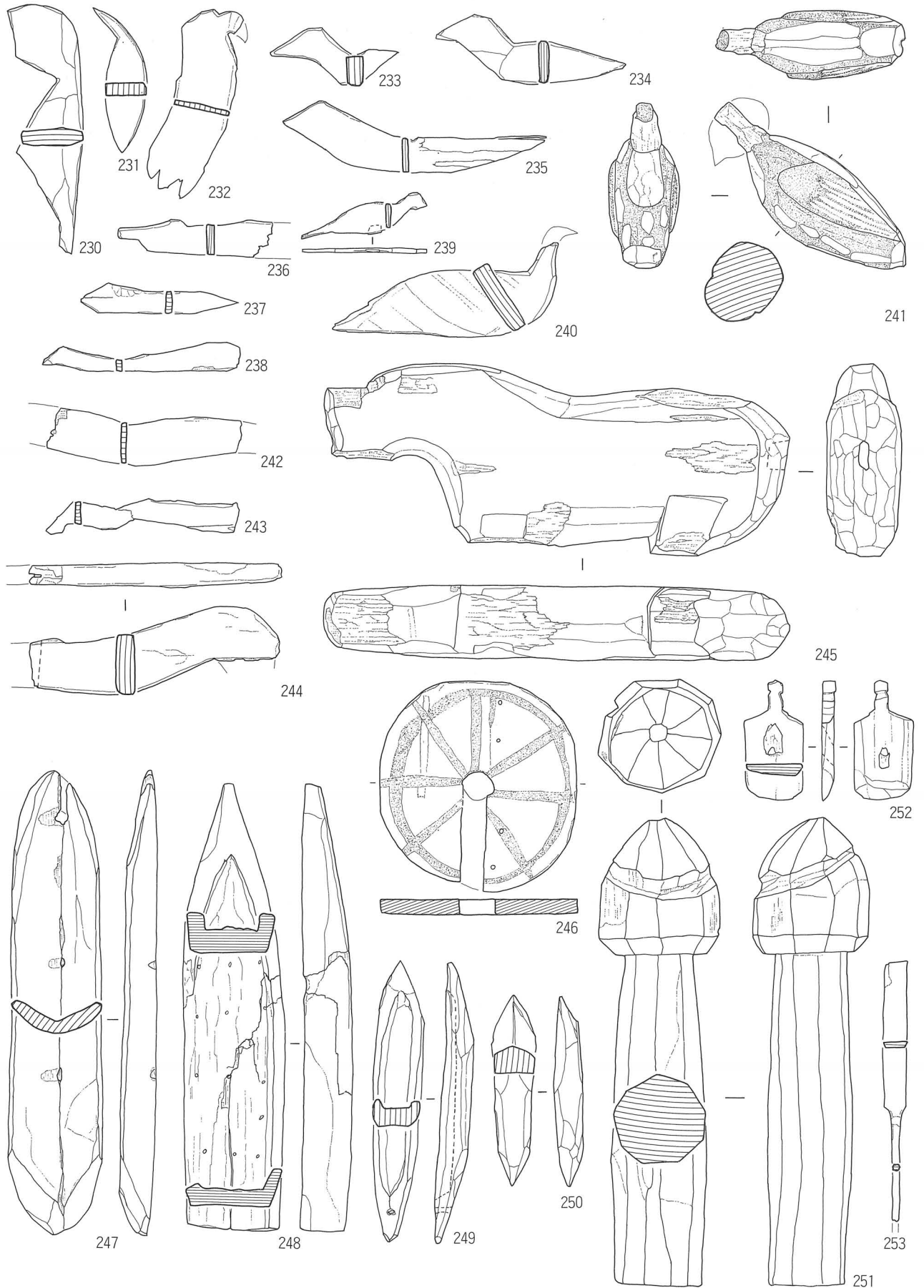

0 20cm

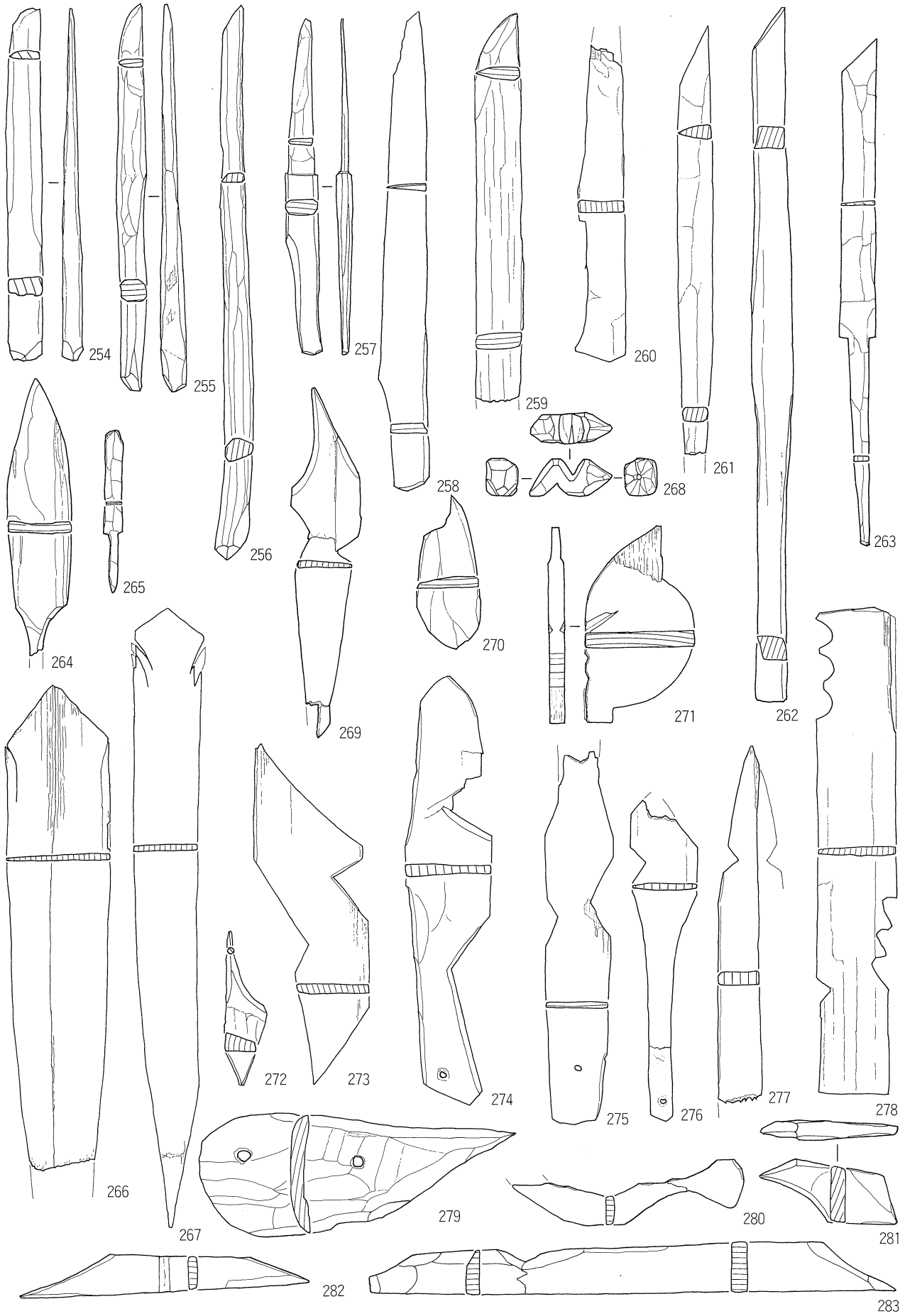

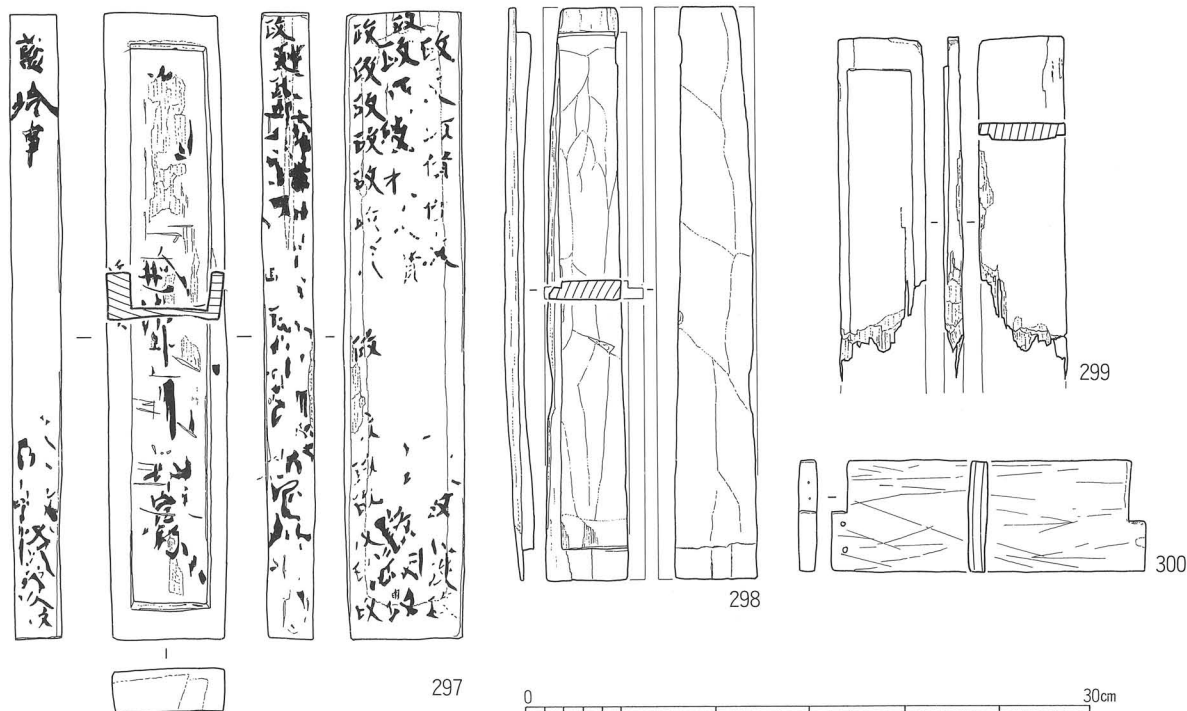
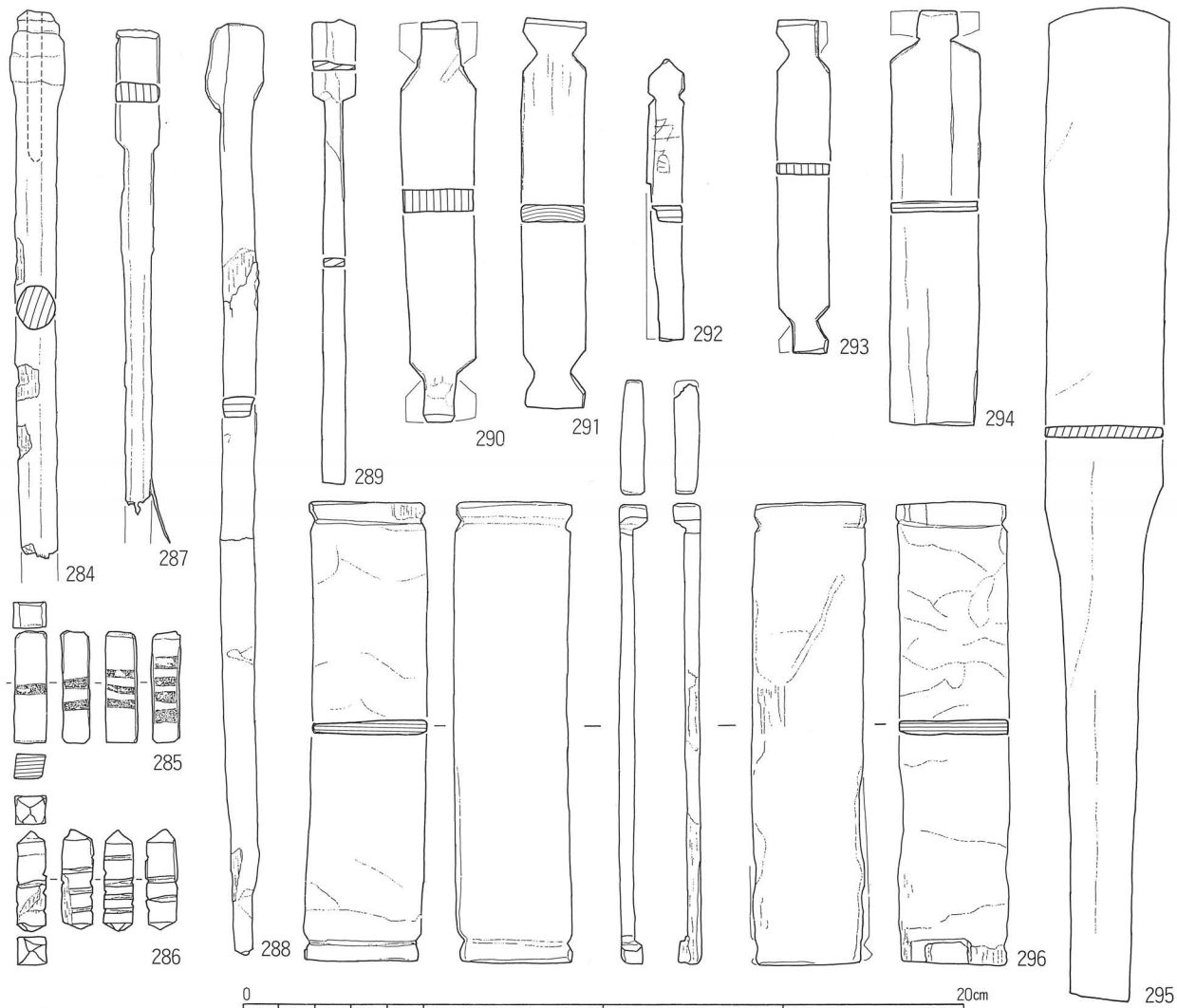

284~295 1 : 2

297~300 1 : 4

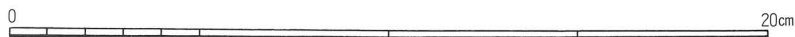
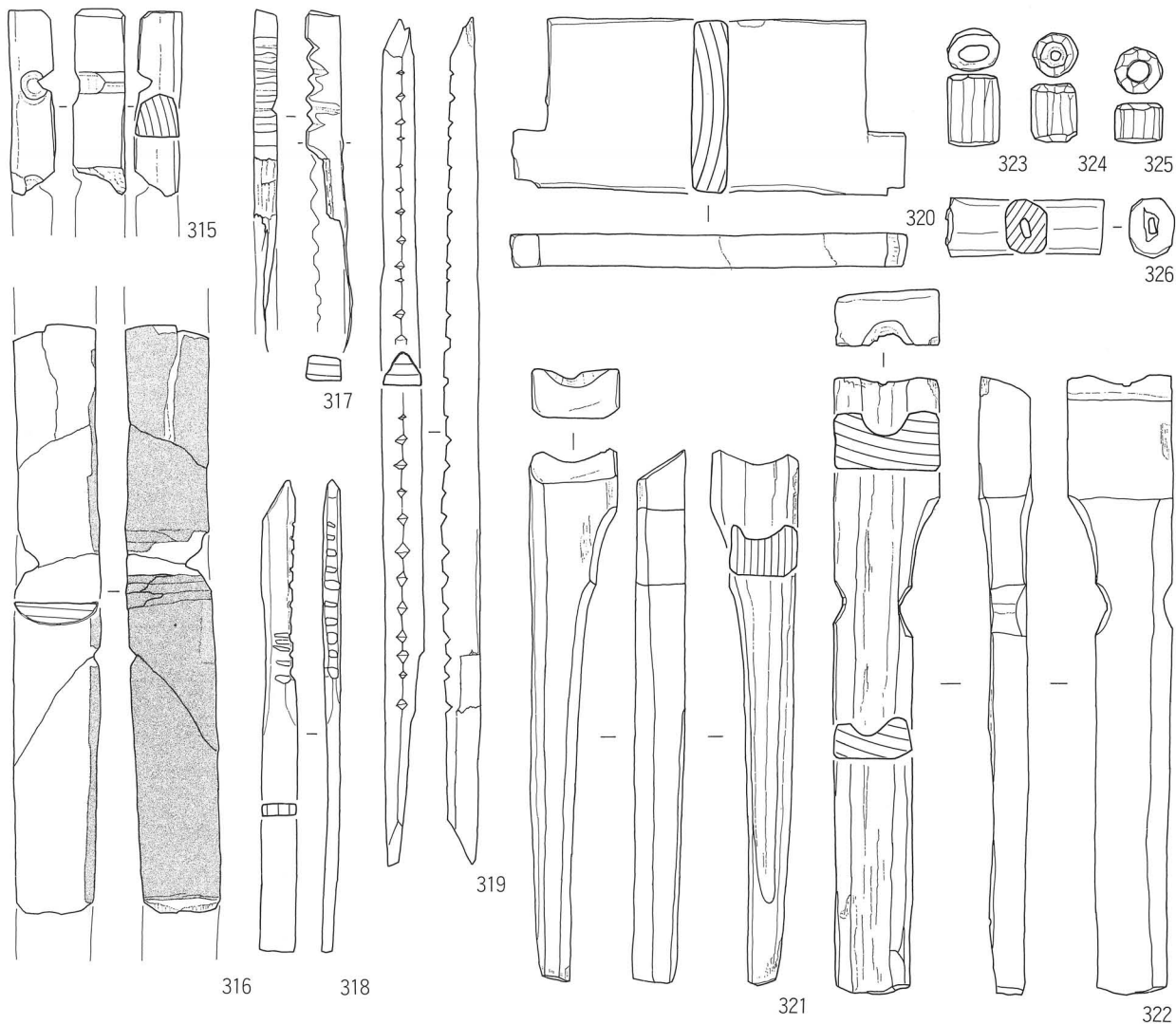
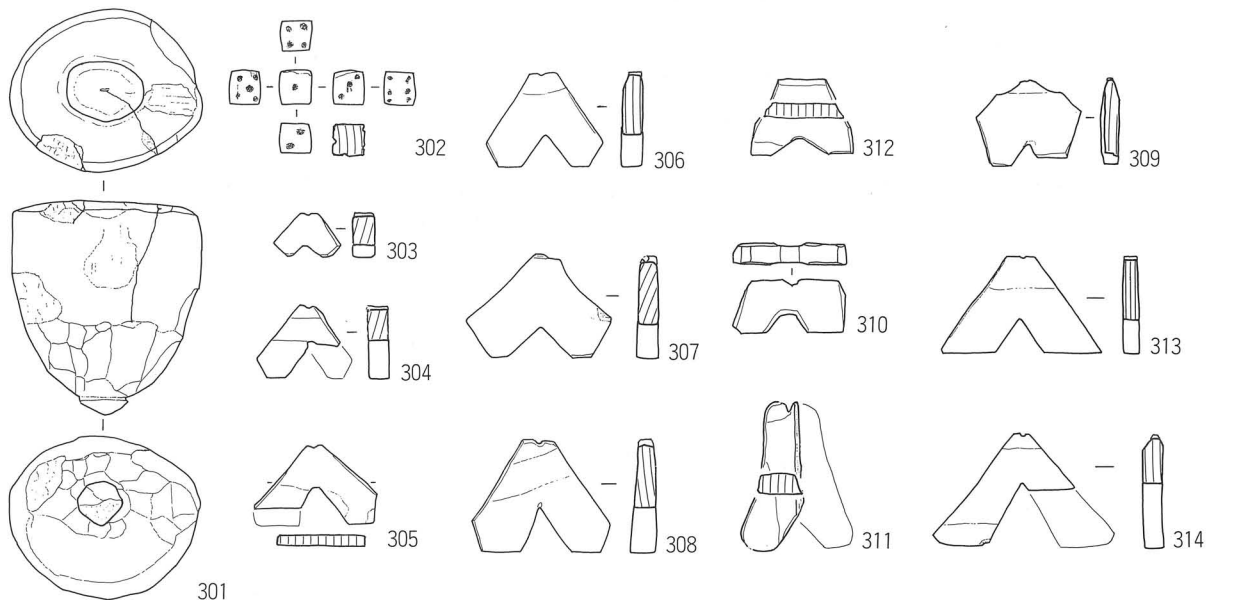

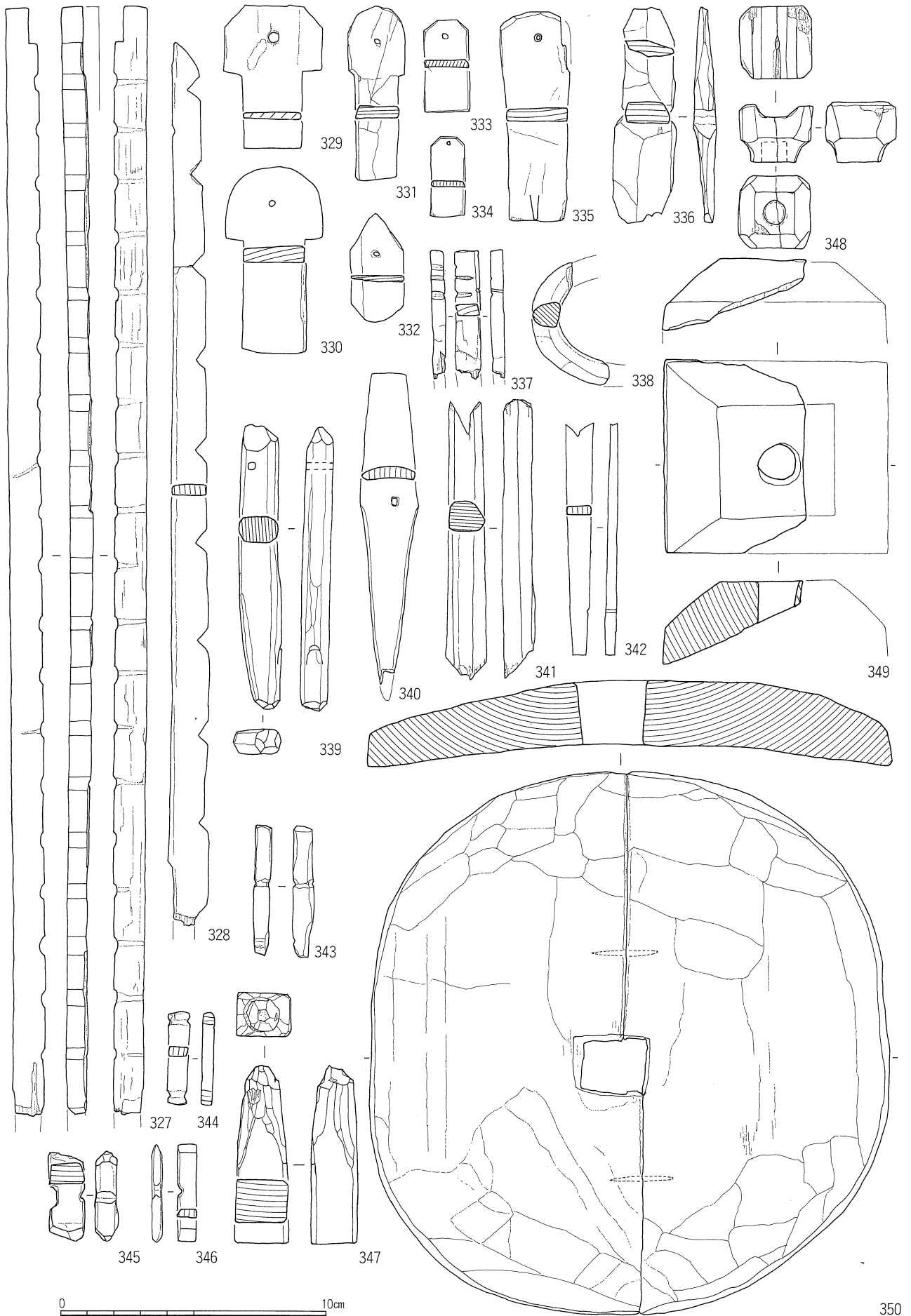

350

1:2

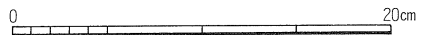
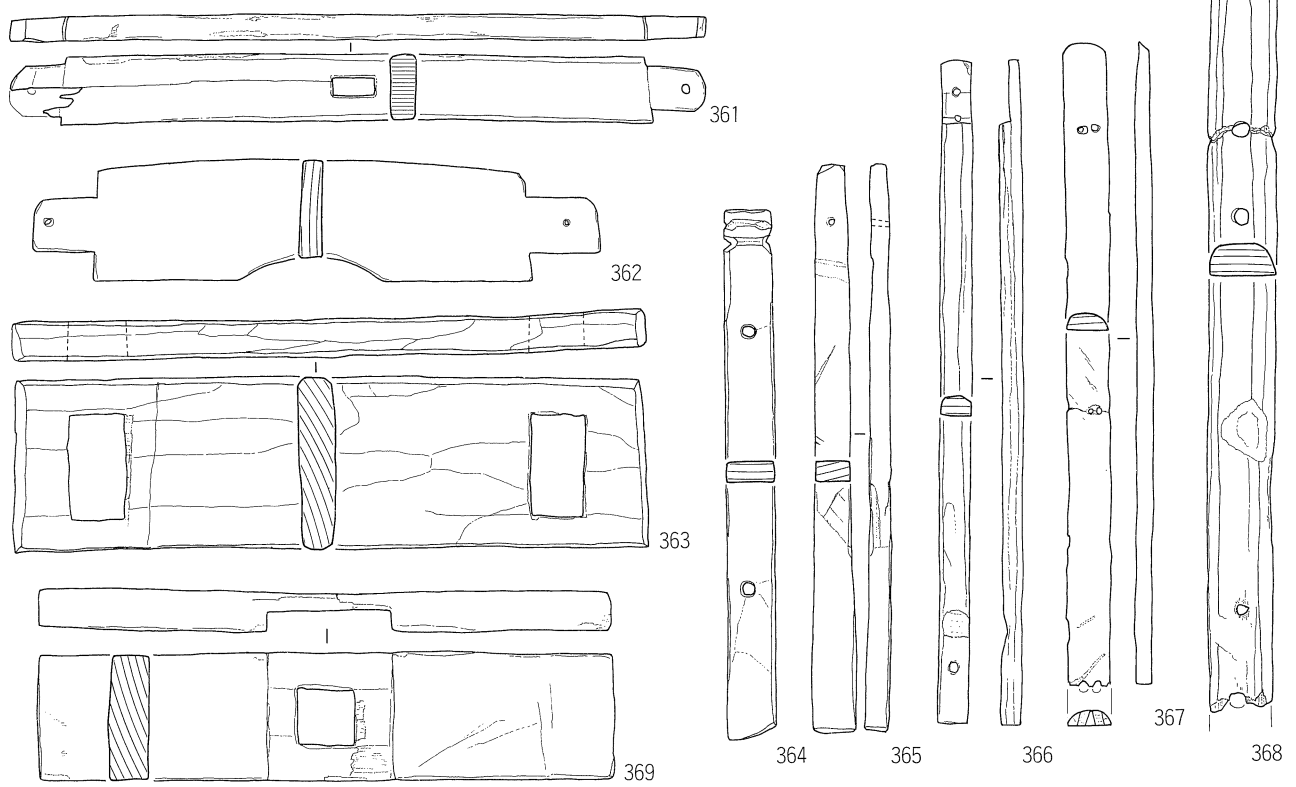
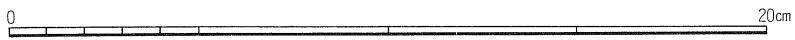
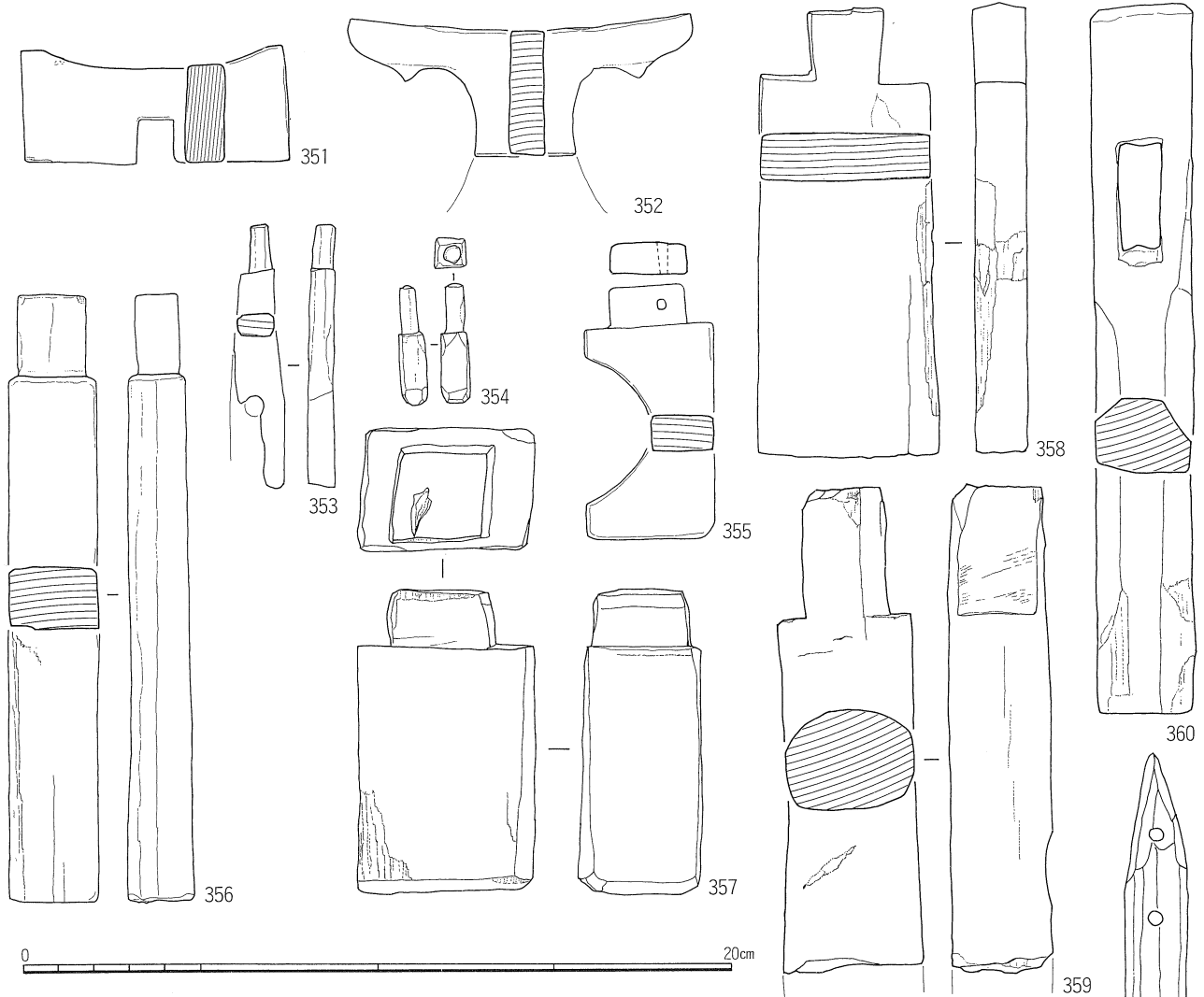

351~360 1 : 2 361~369 1 : 4

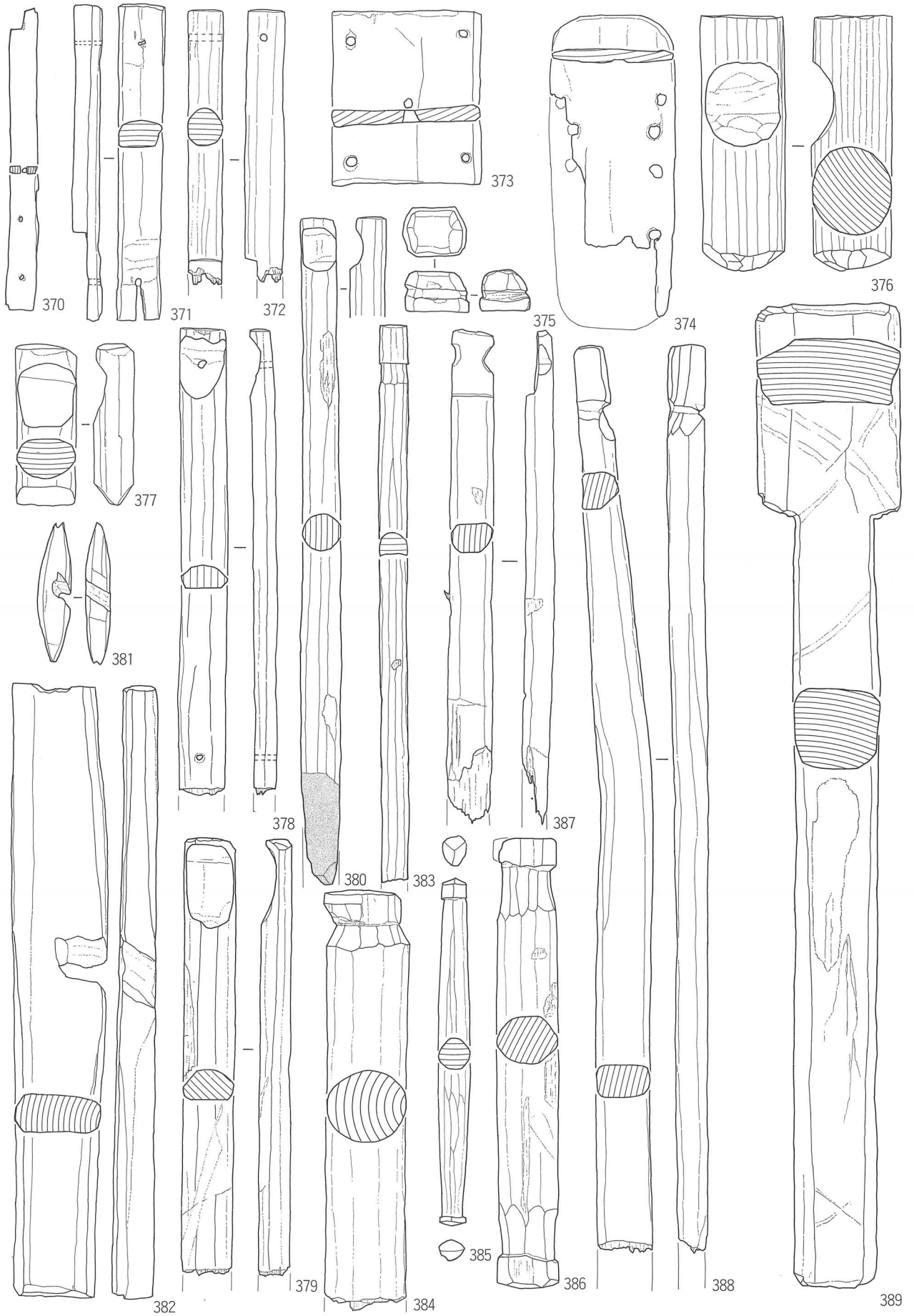

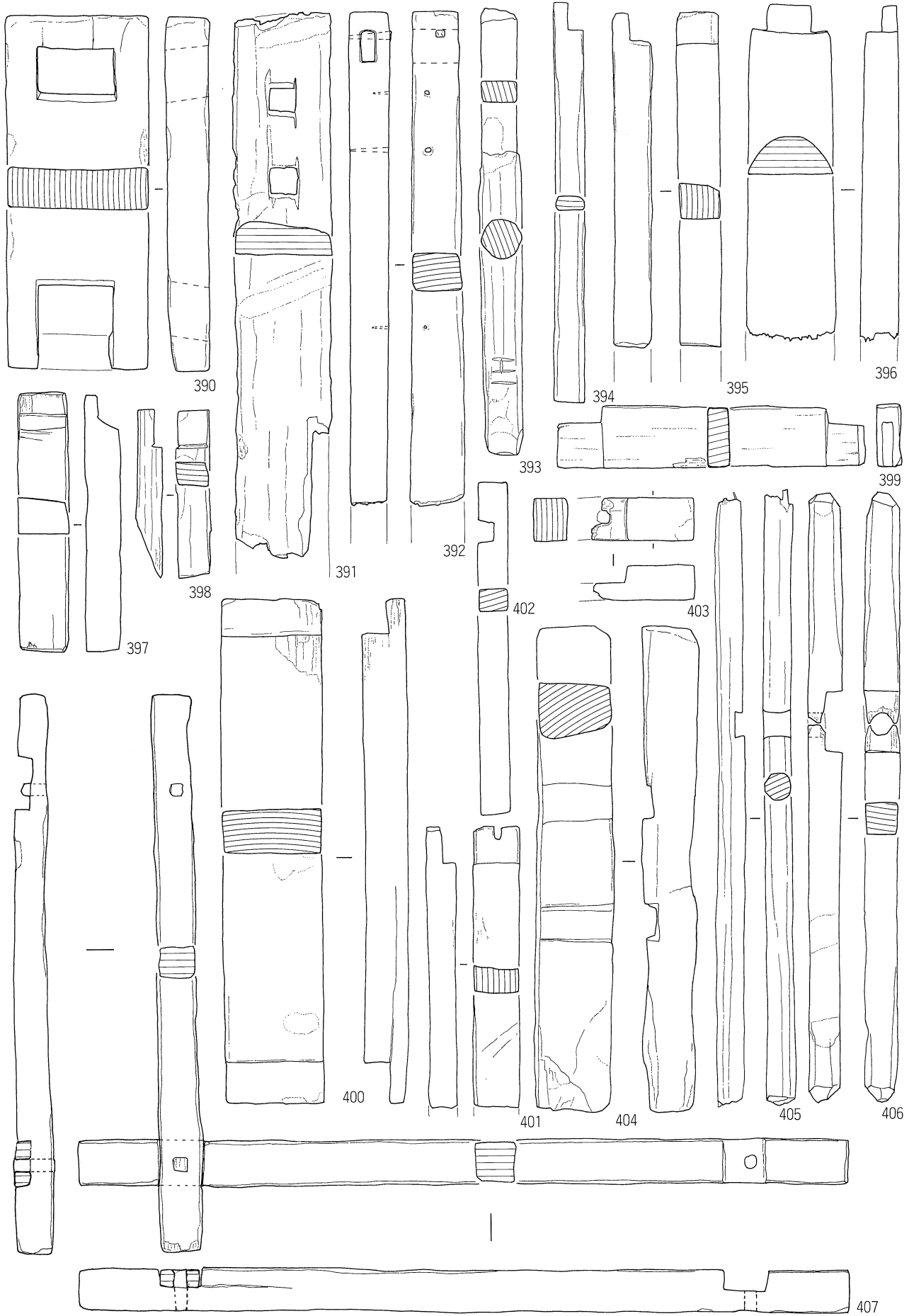

0 20cm

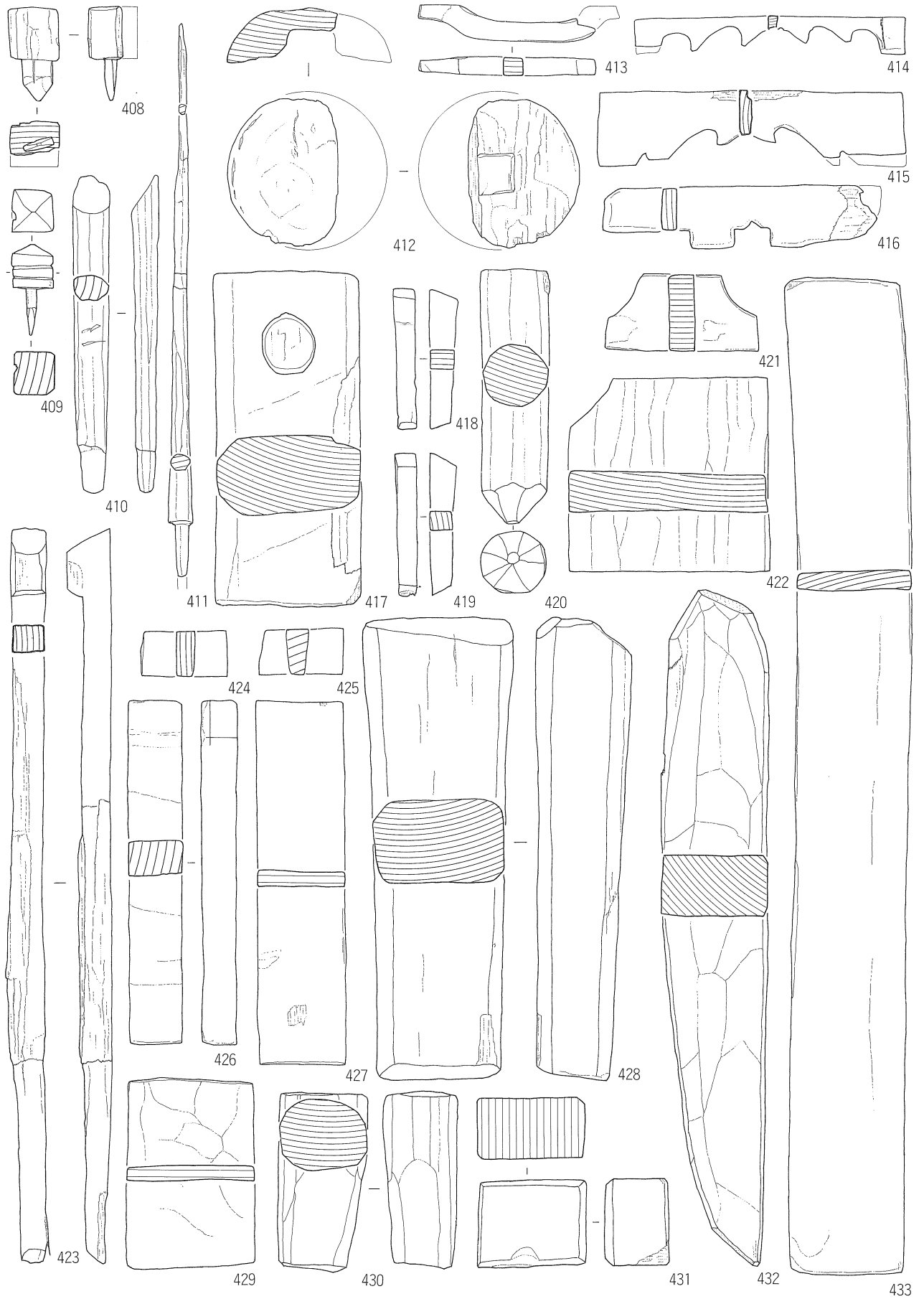

0 20cm

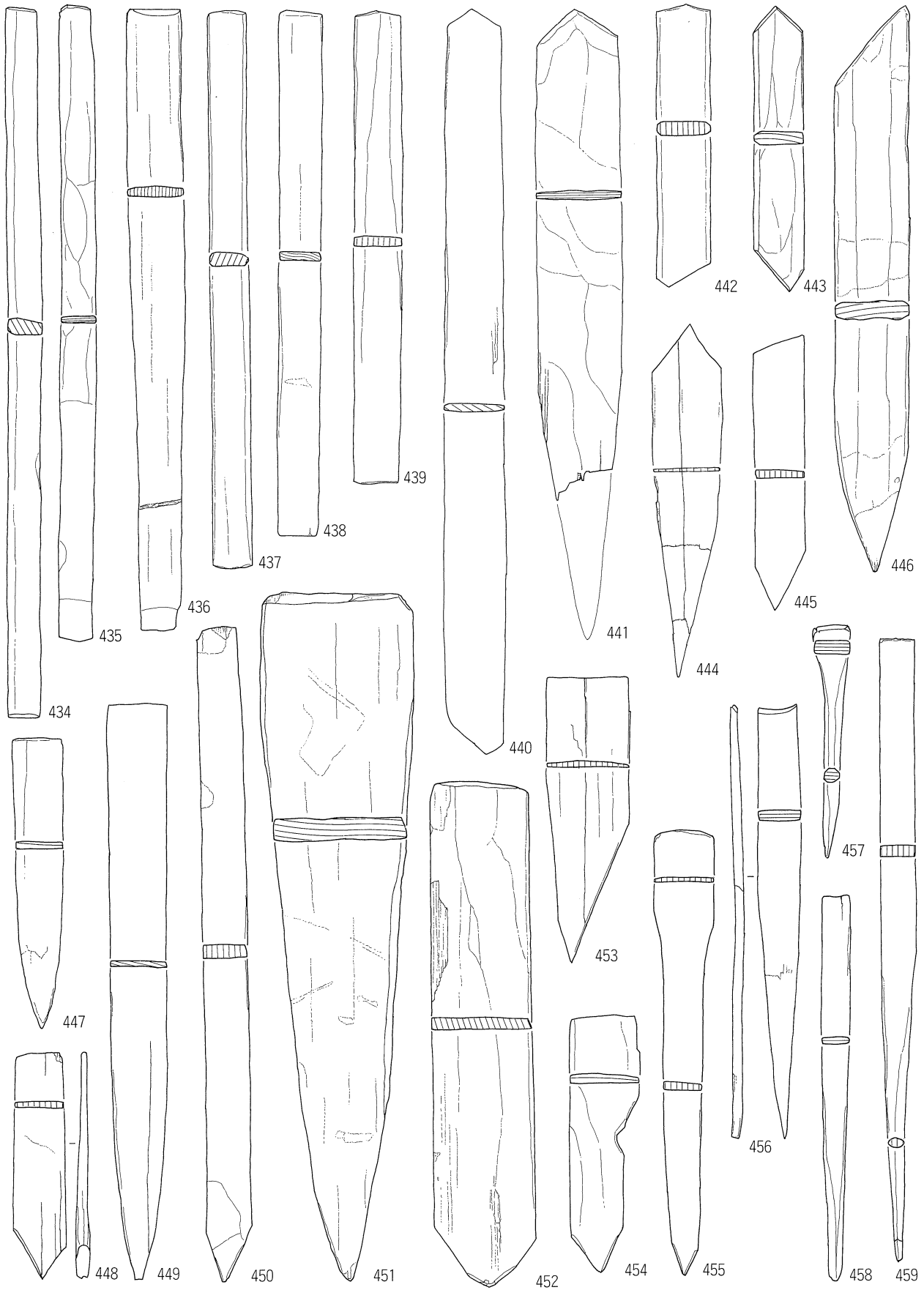

0 20cm

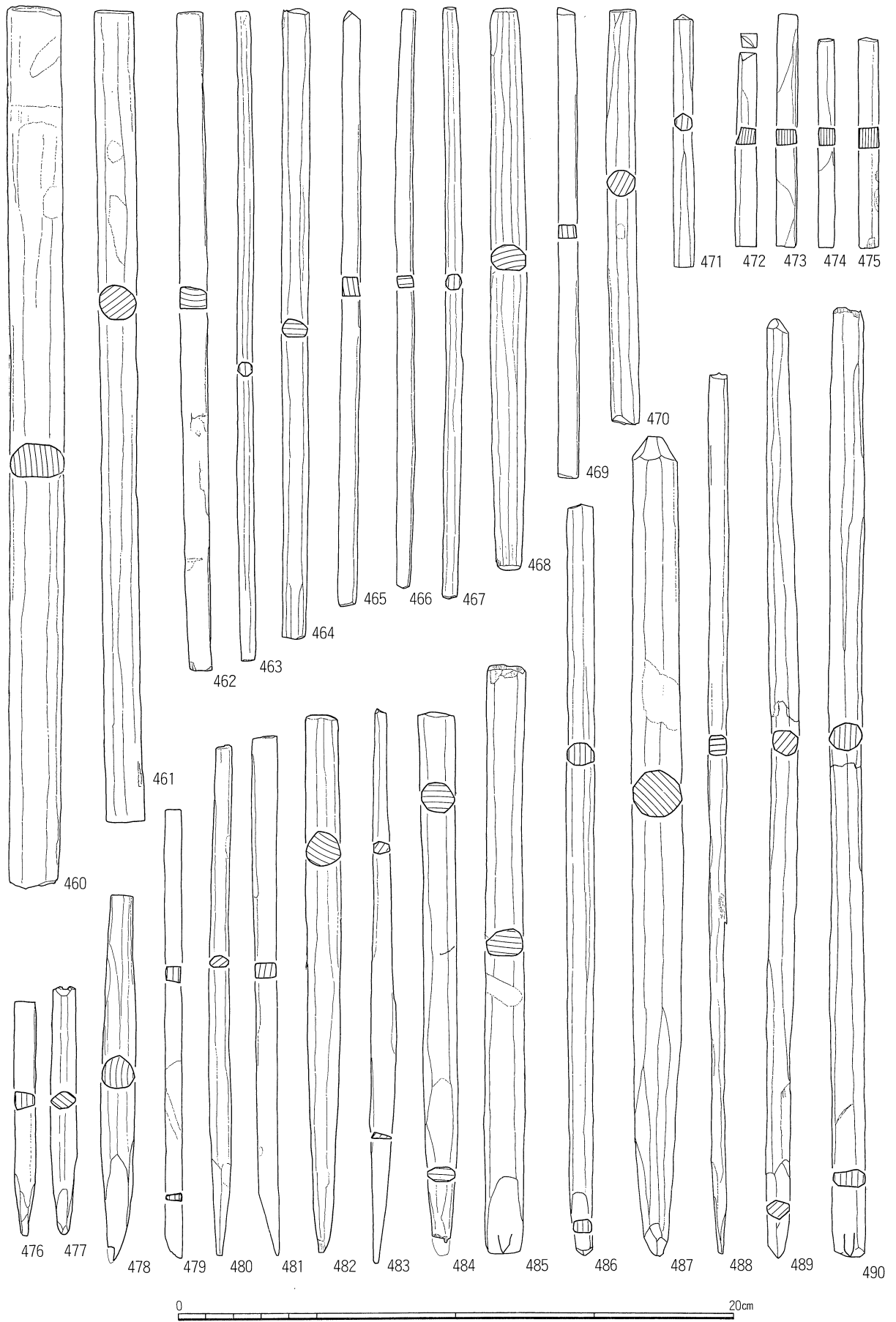

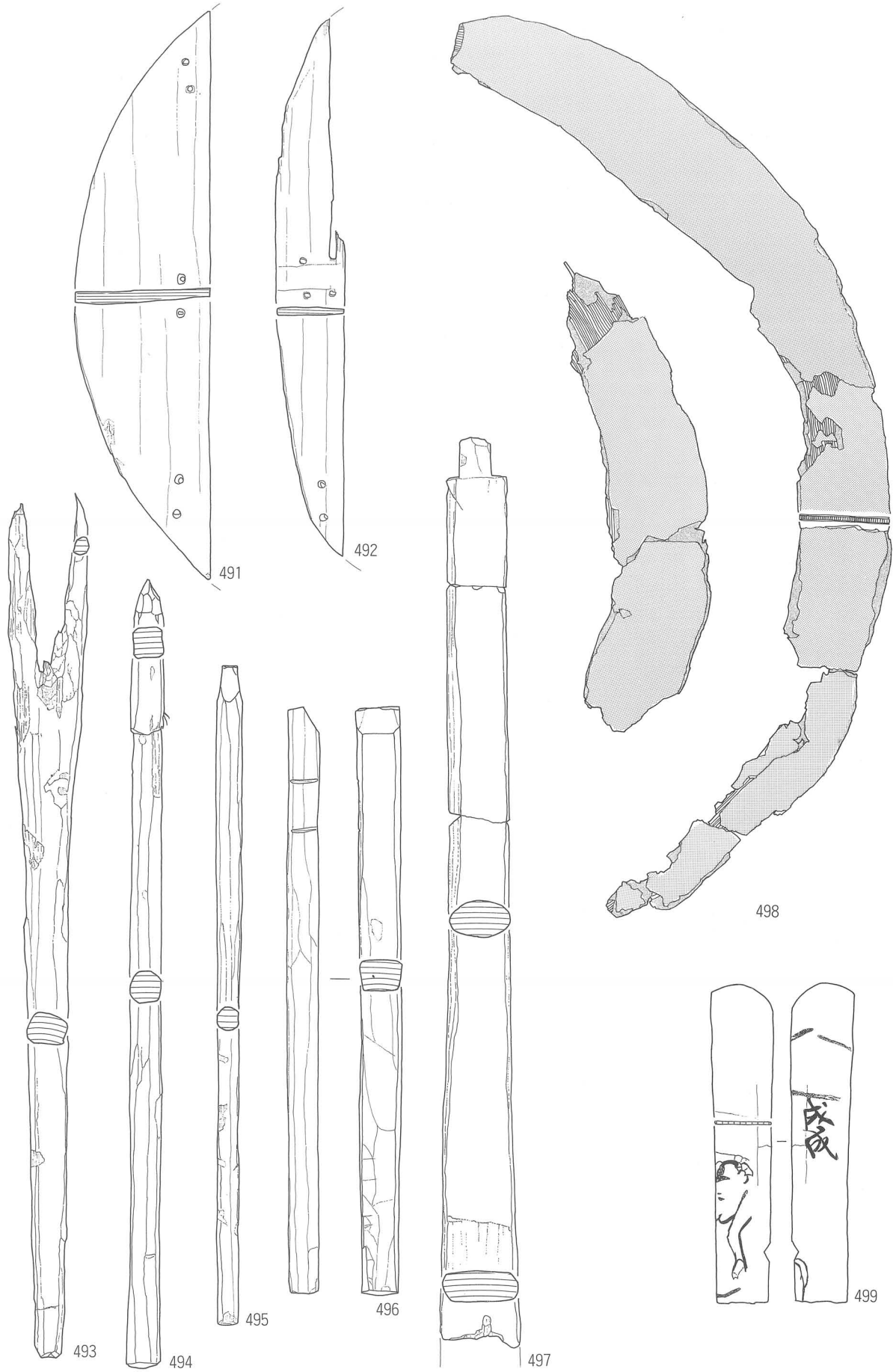

0 30cm

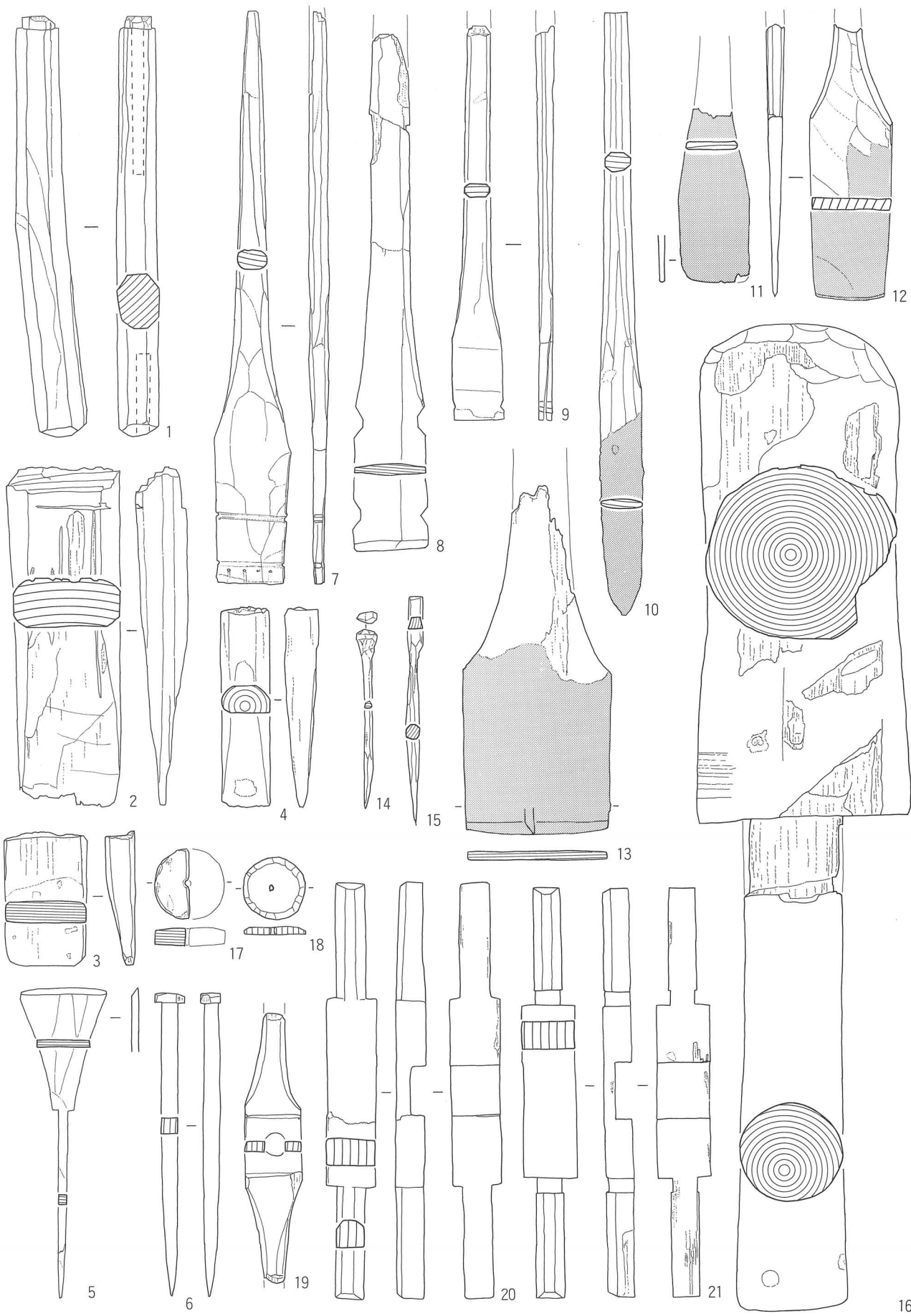

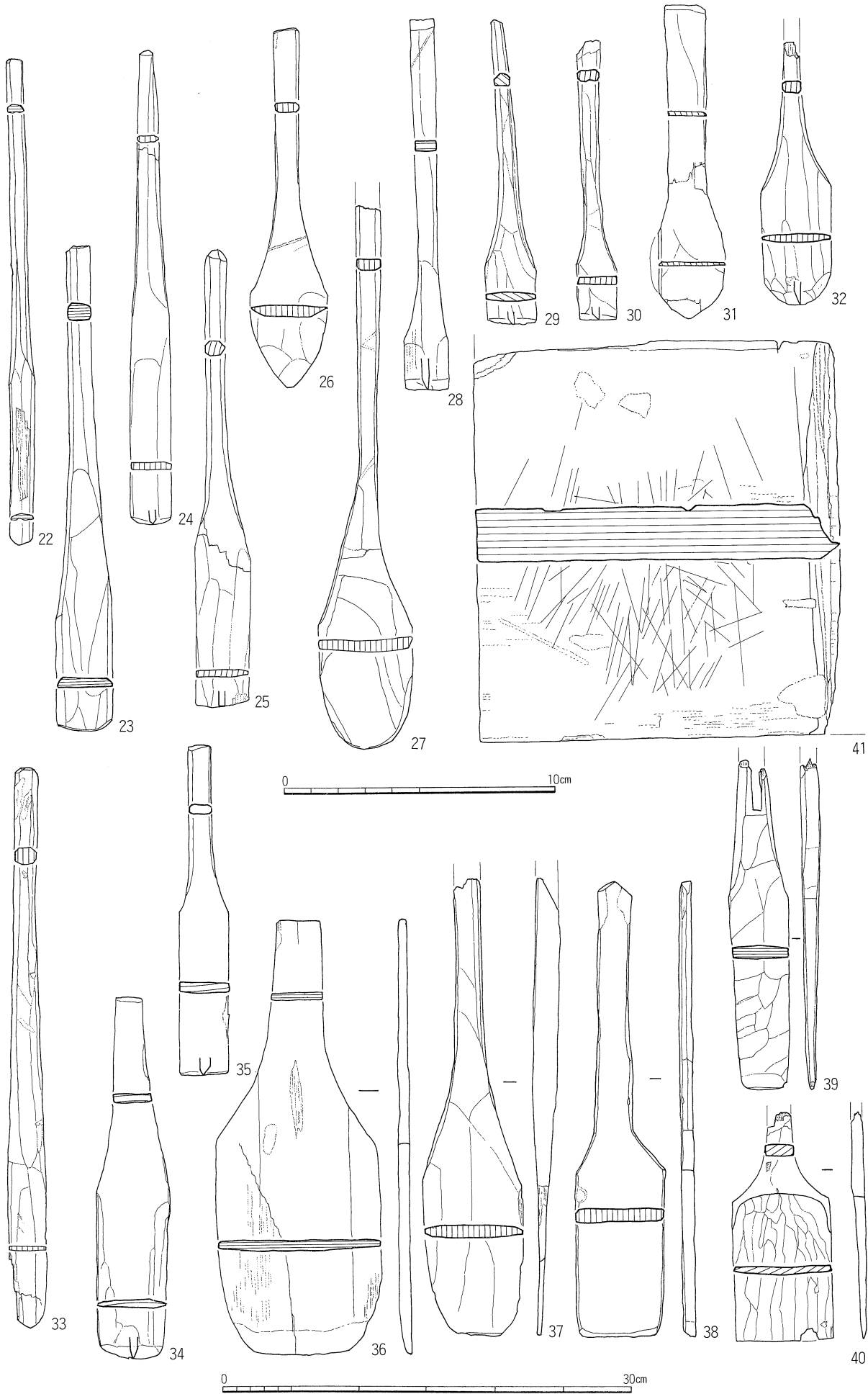

22~32・41 1 : 2

33~40 1 : 4

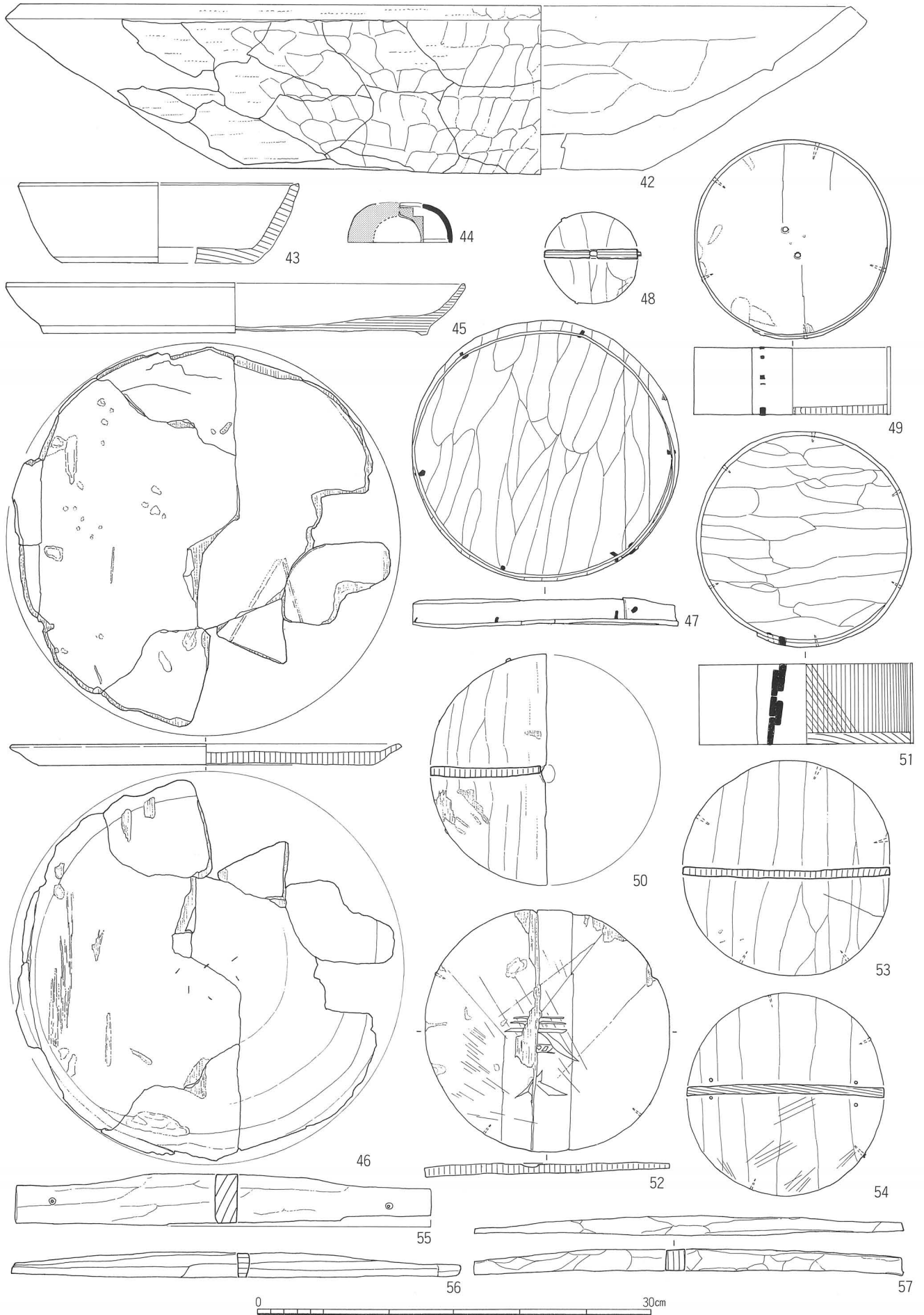

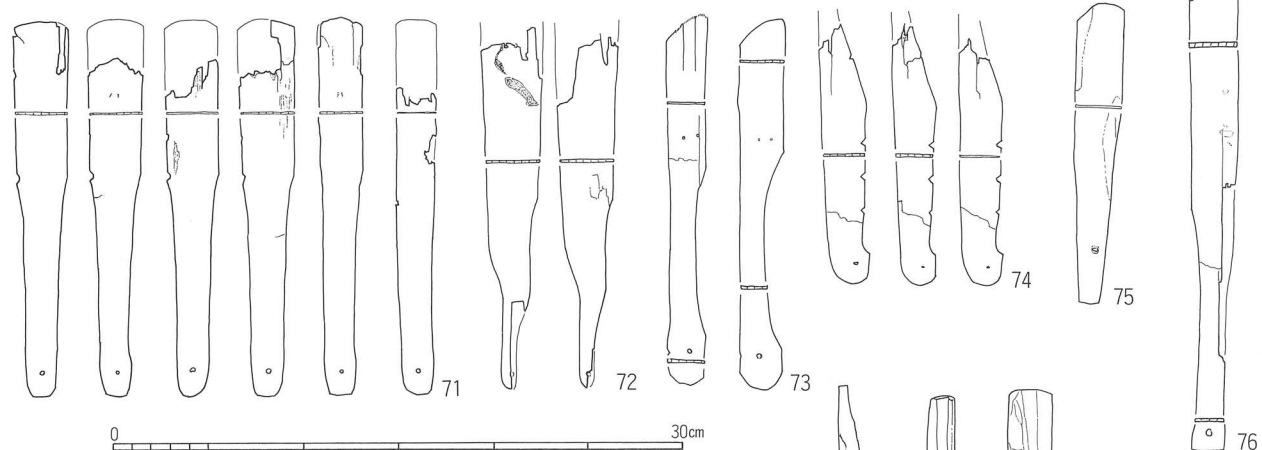
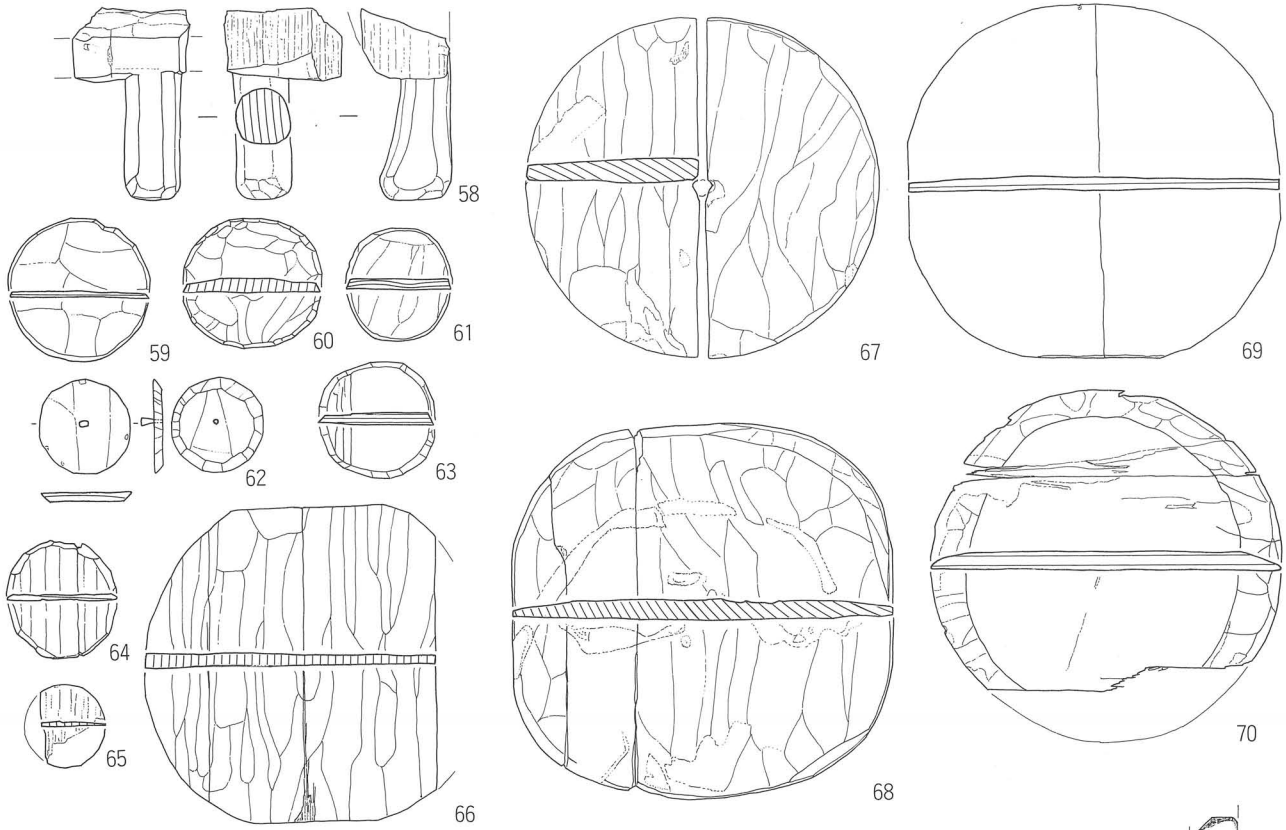

0 30cm

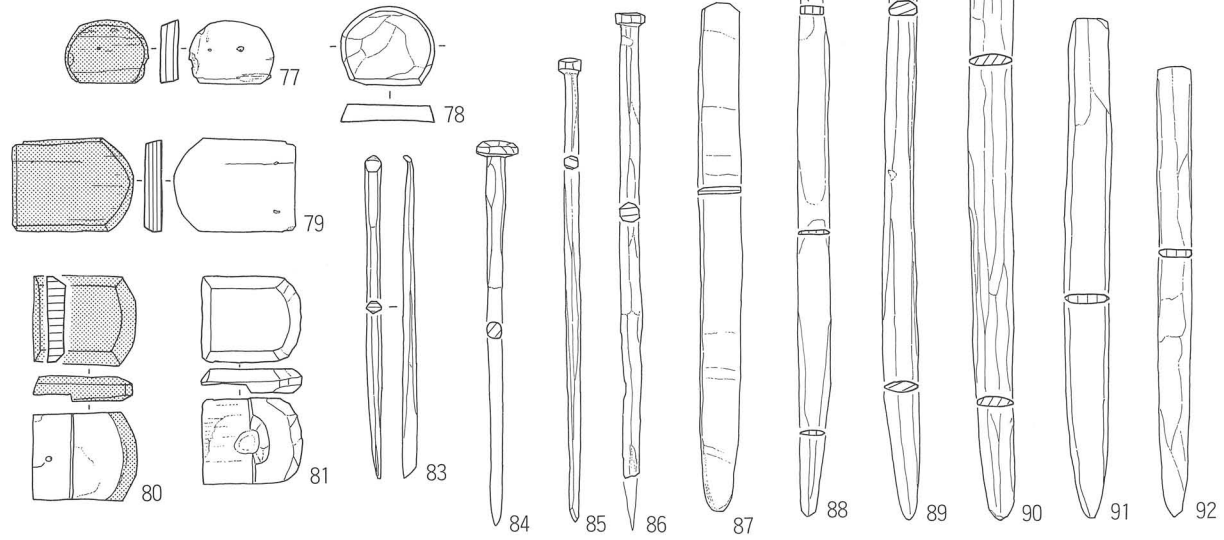

0 10cm

58~76 1:4 77~92 1:2

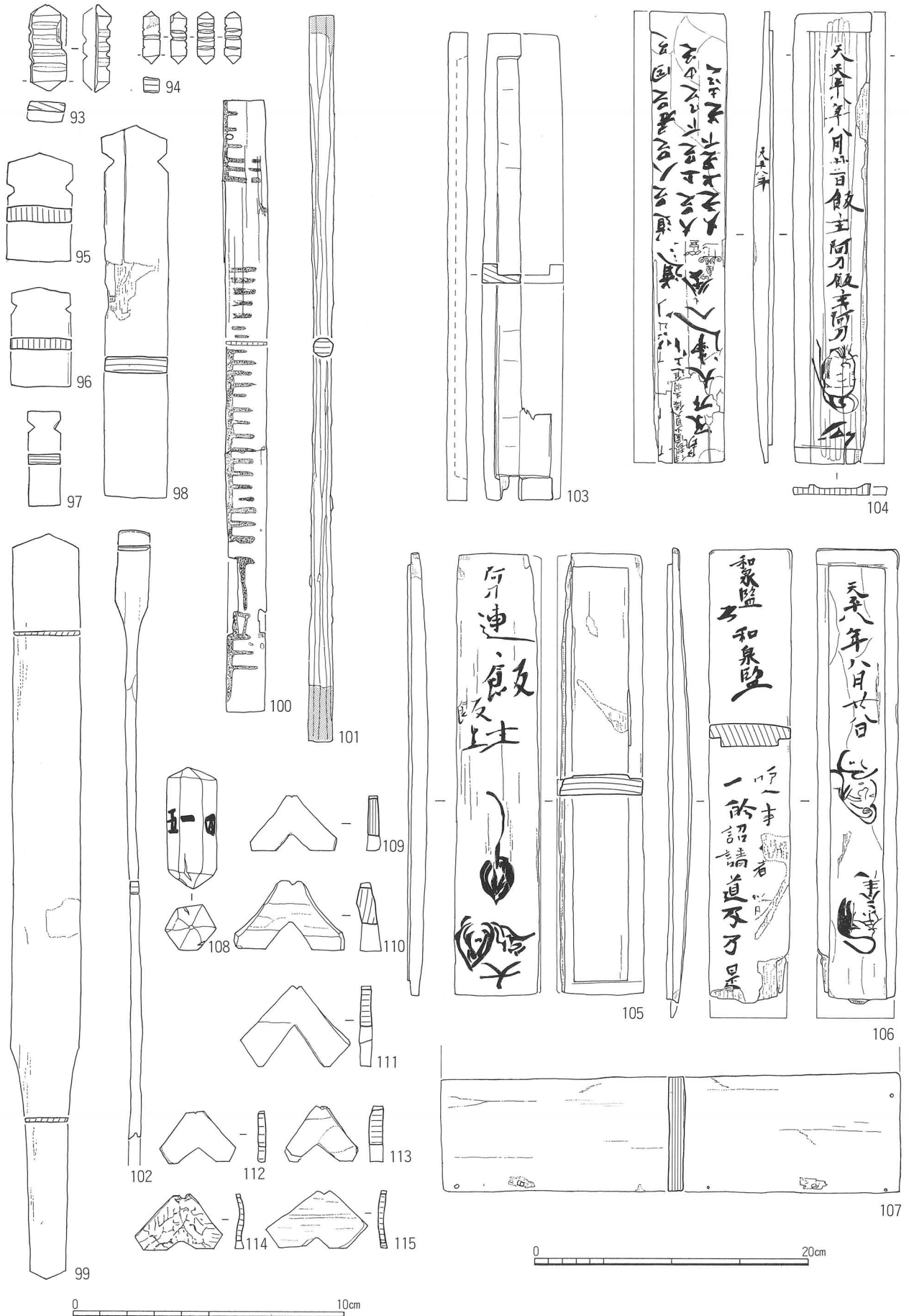

93~102・108~115 1:2

103~107 1:4

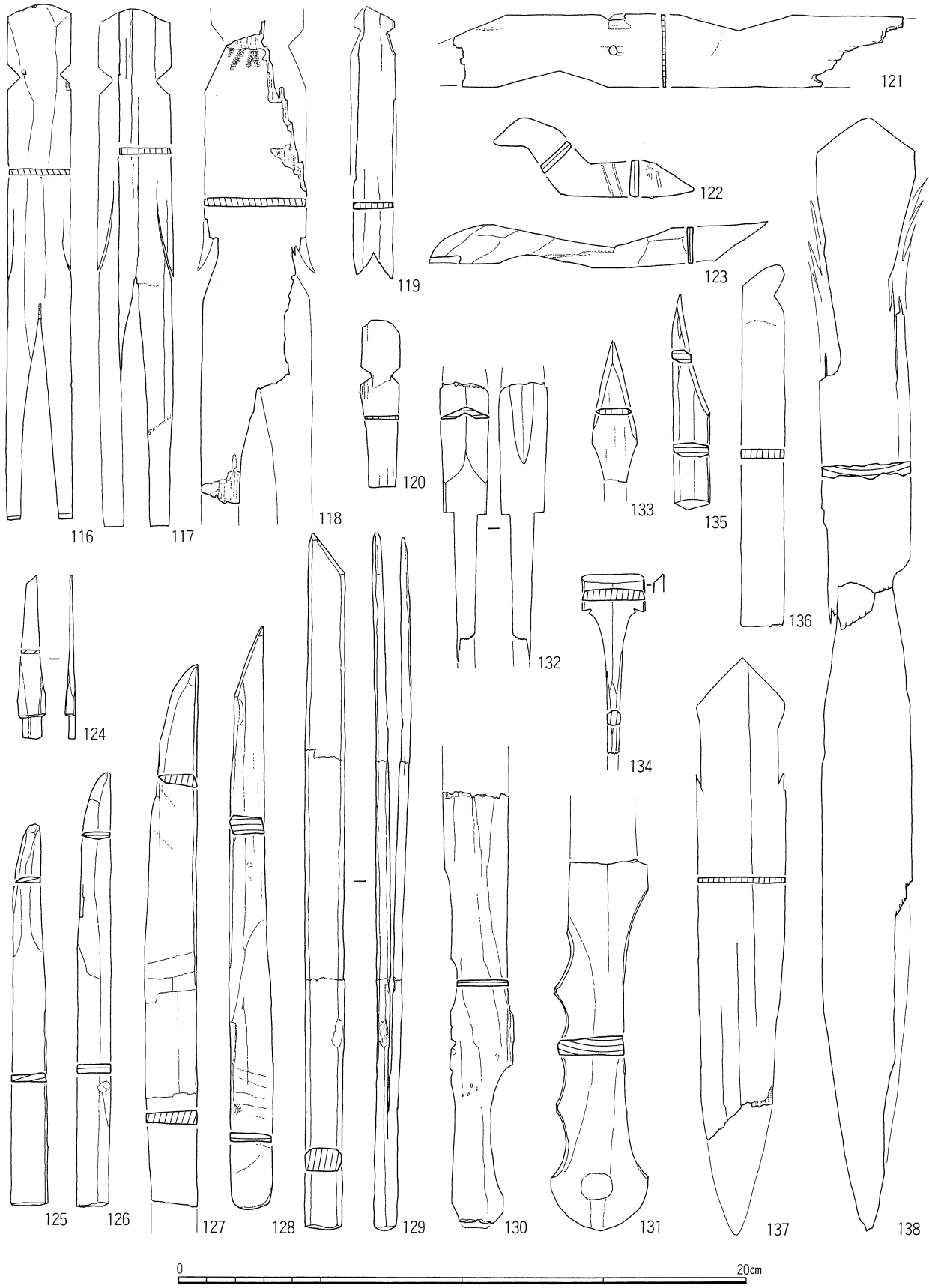

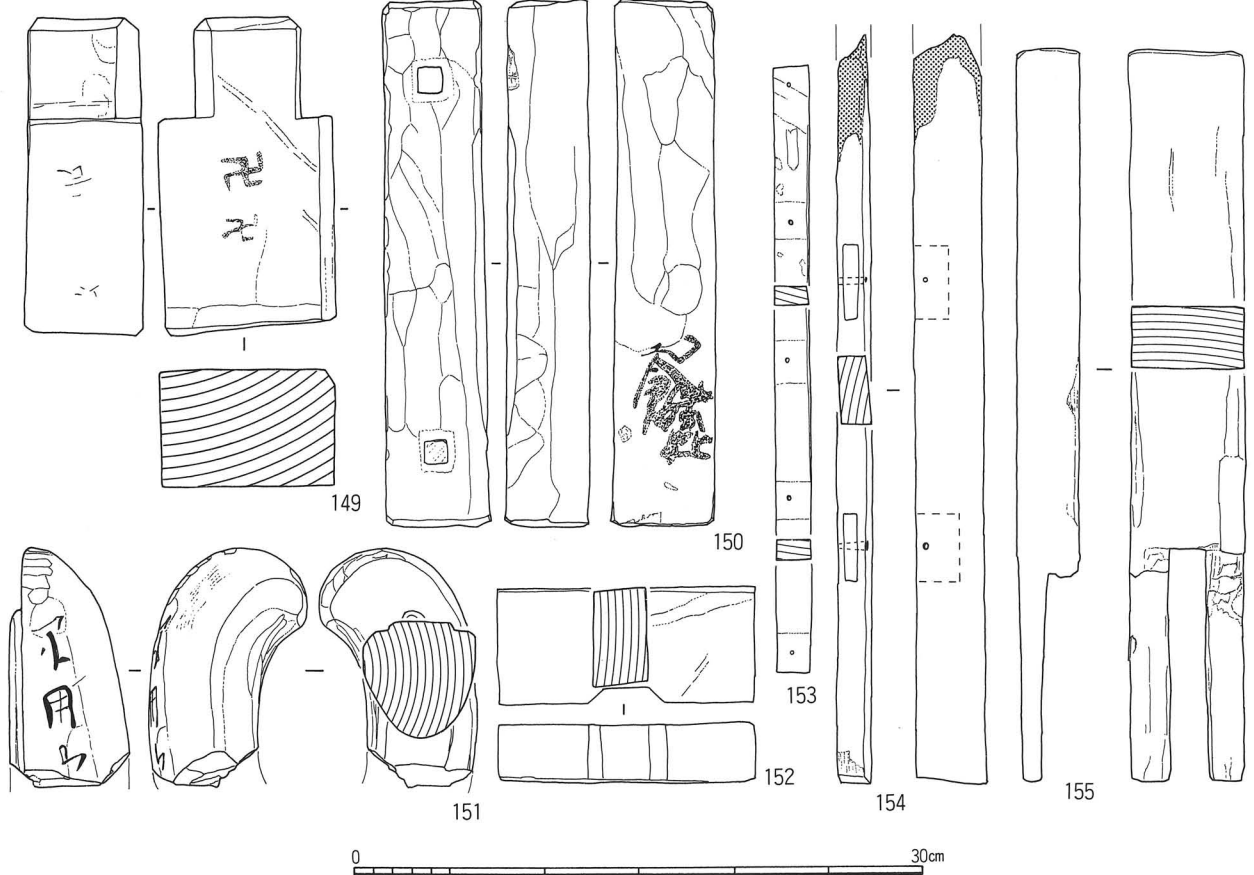
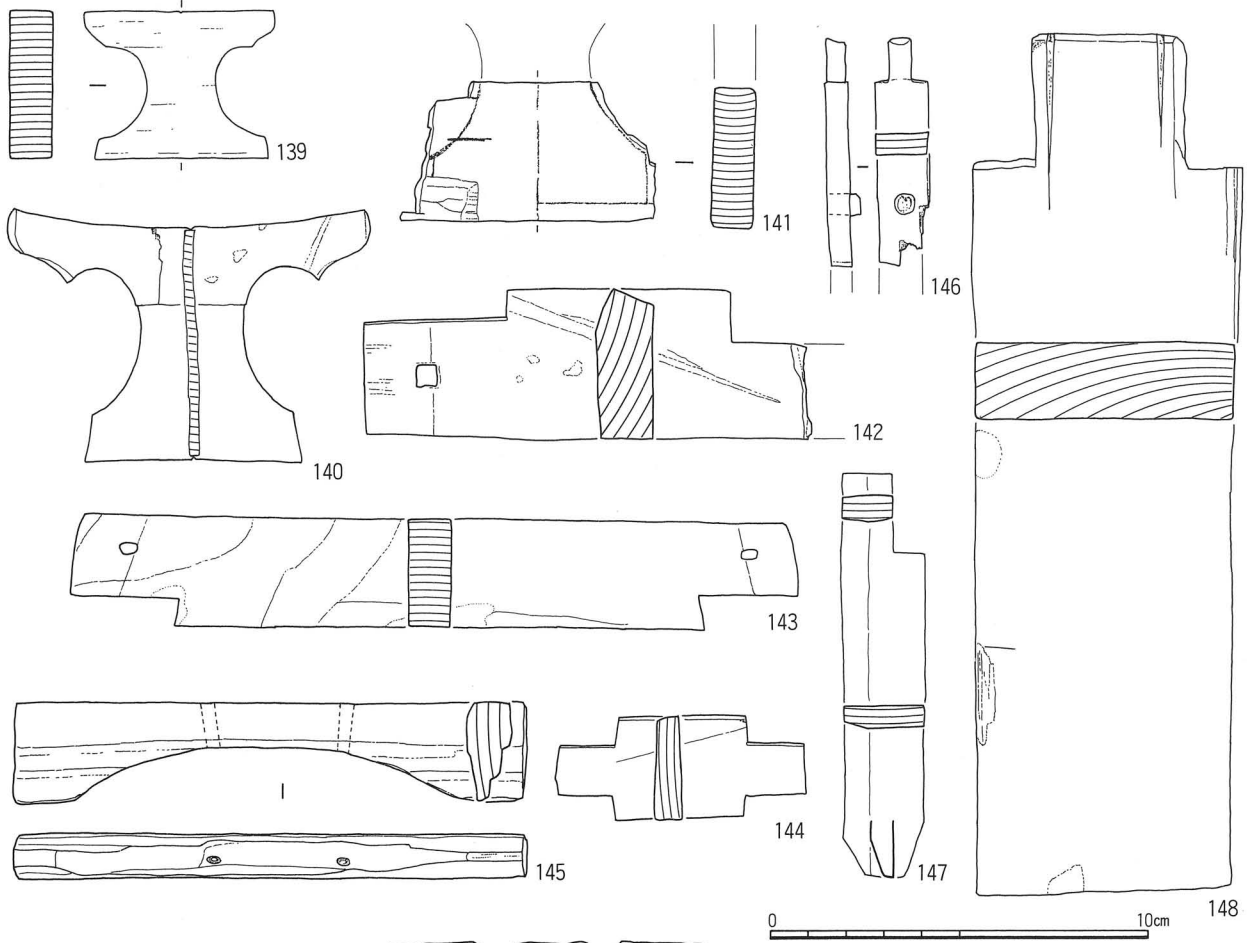

139~148 1 : 2

149~155 1 : 4

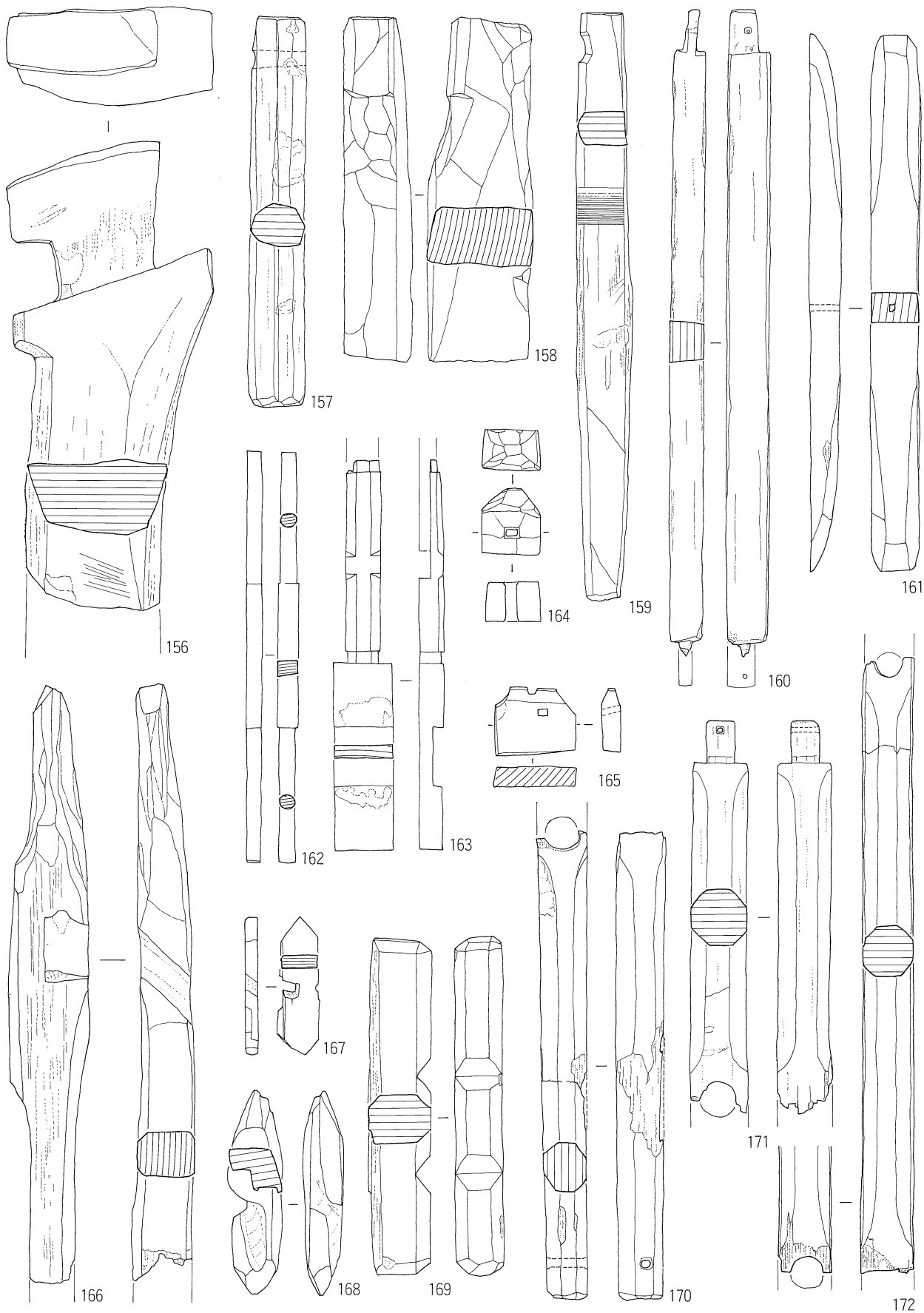

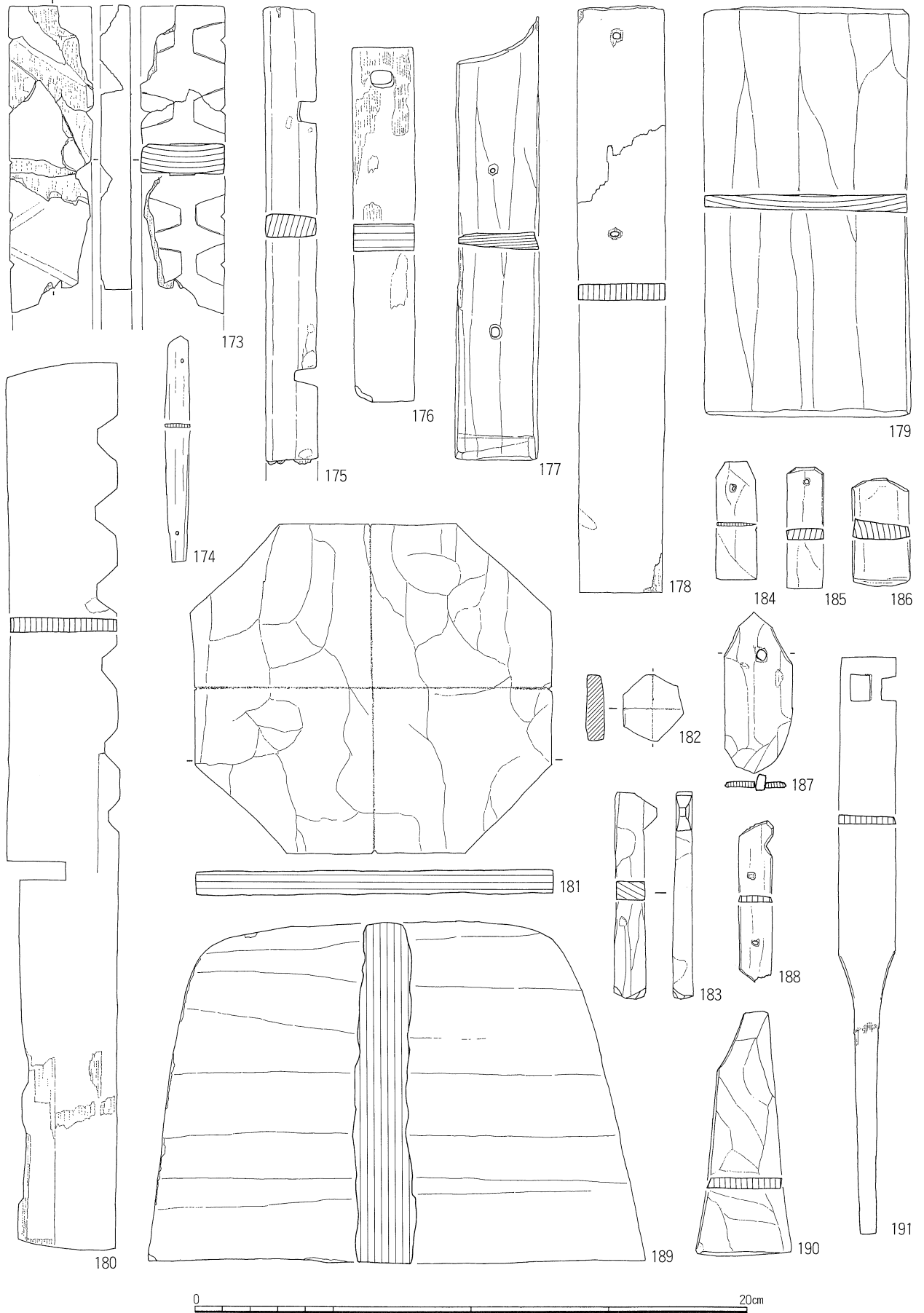

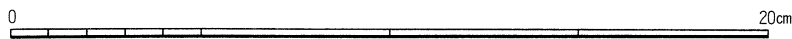
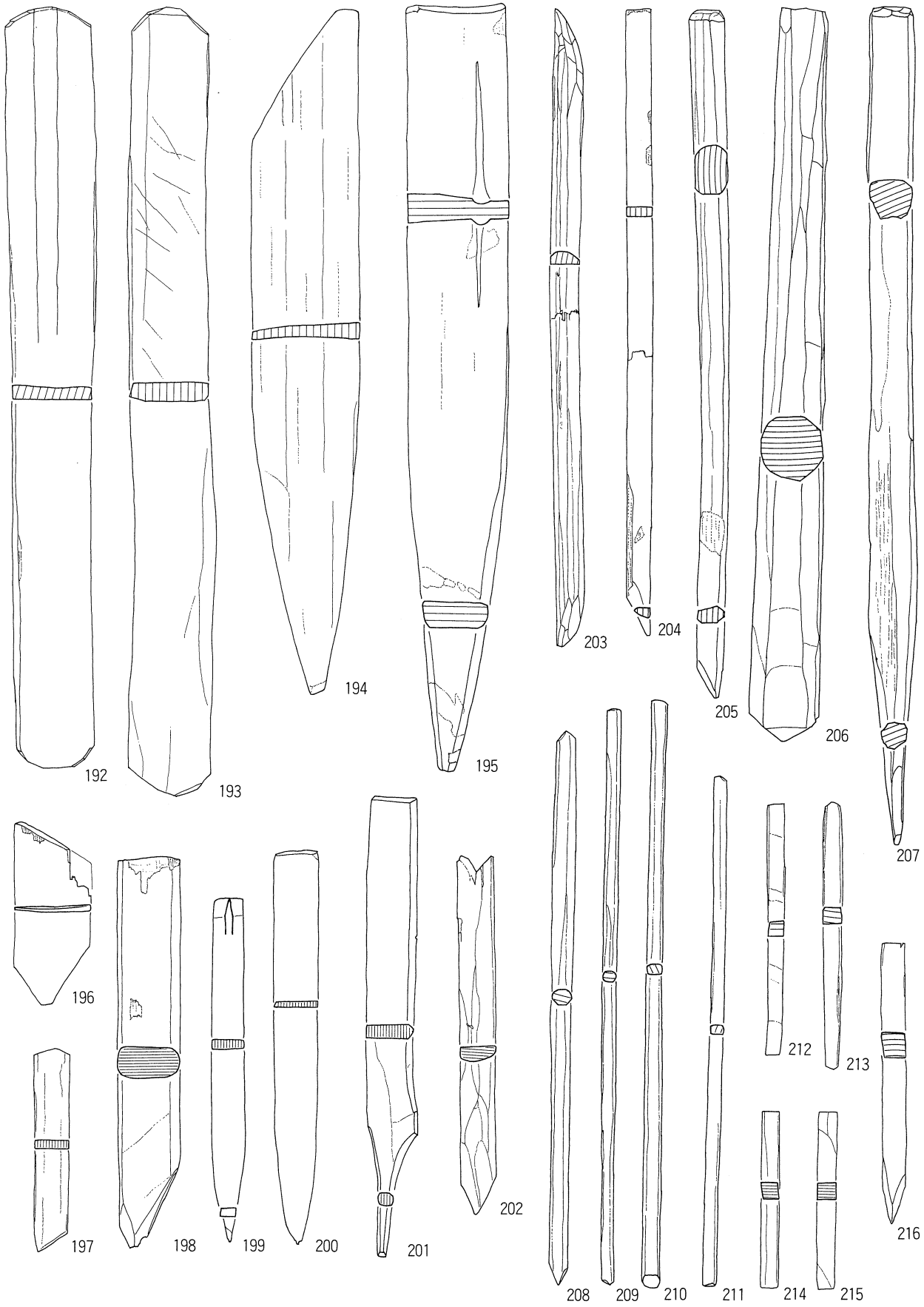

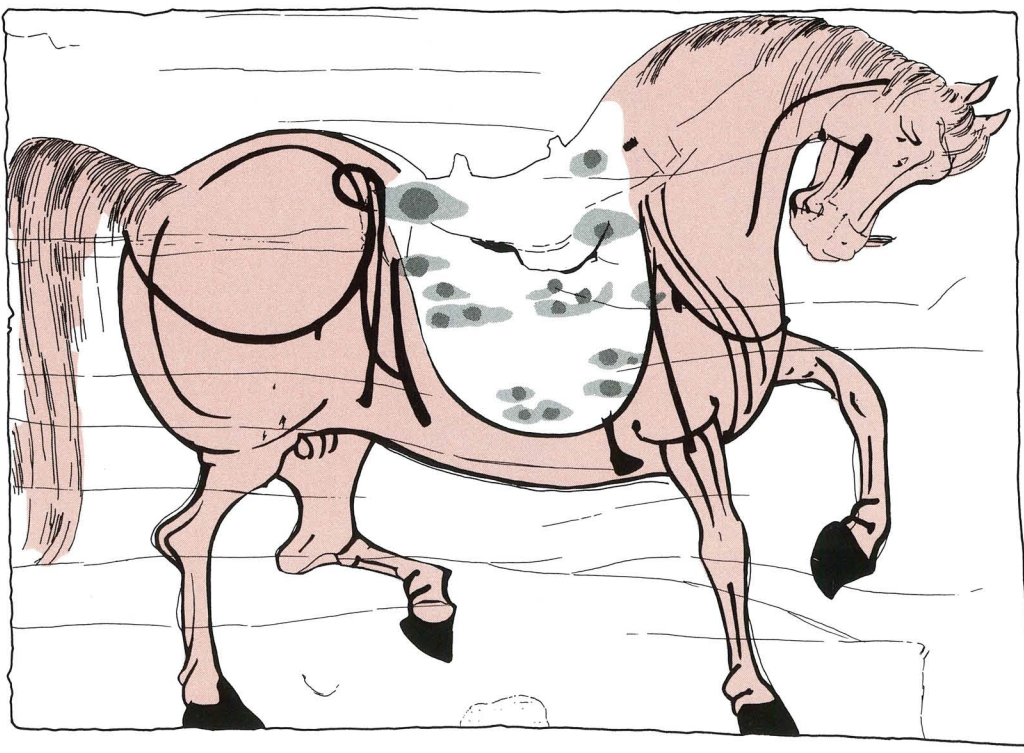
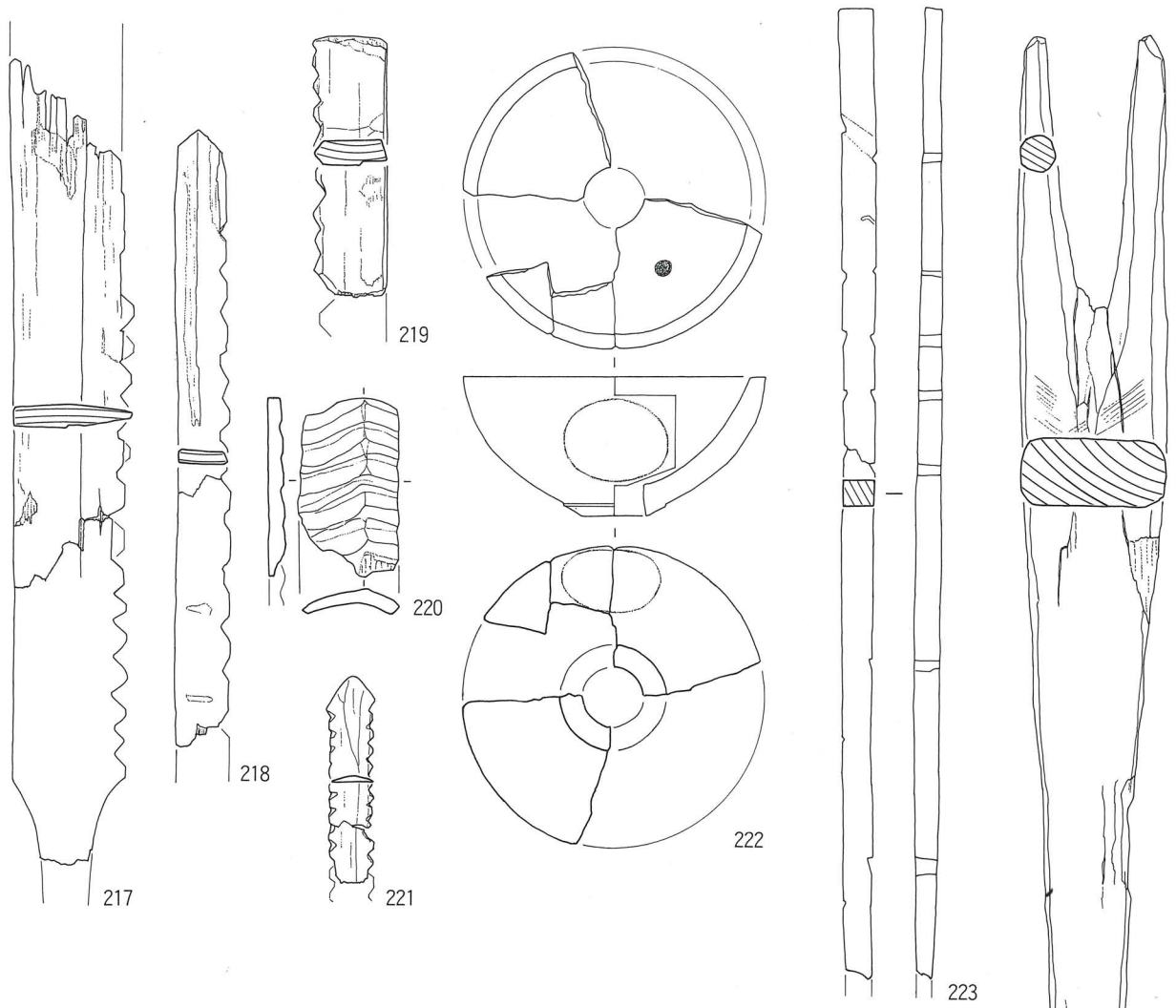

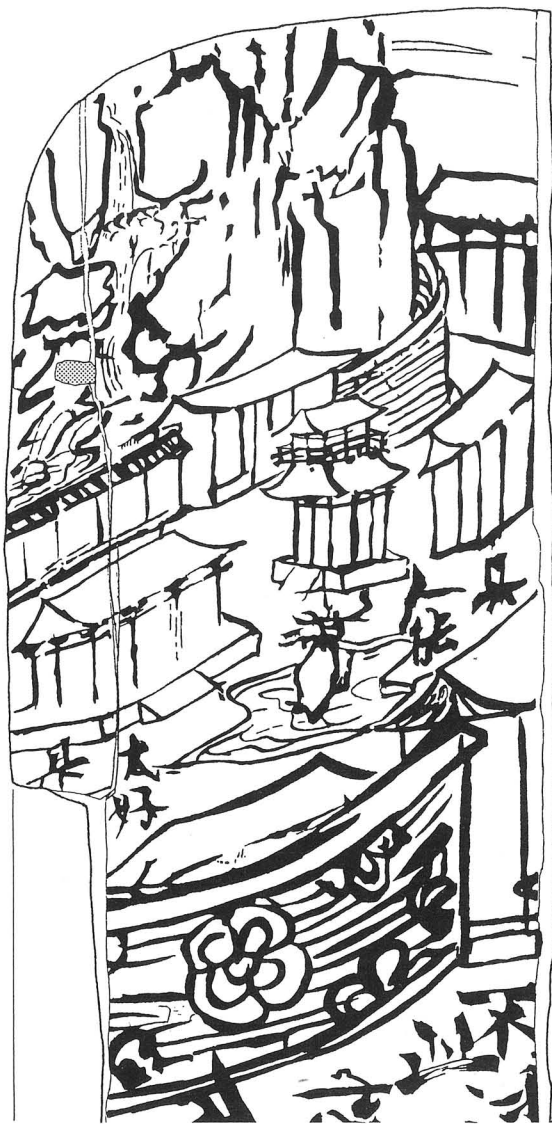

0 10cm



0 10cm

226

1:3(左は拡大図 2:3)

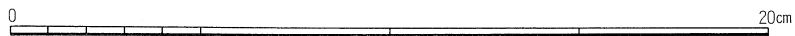
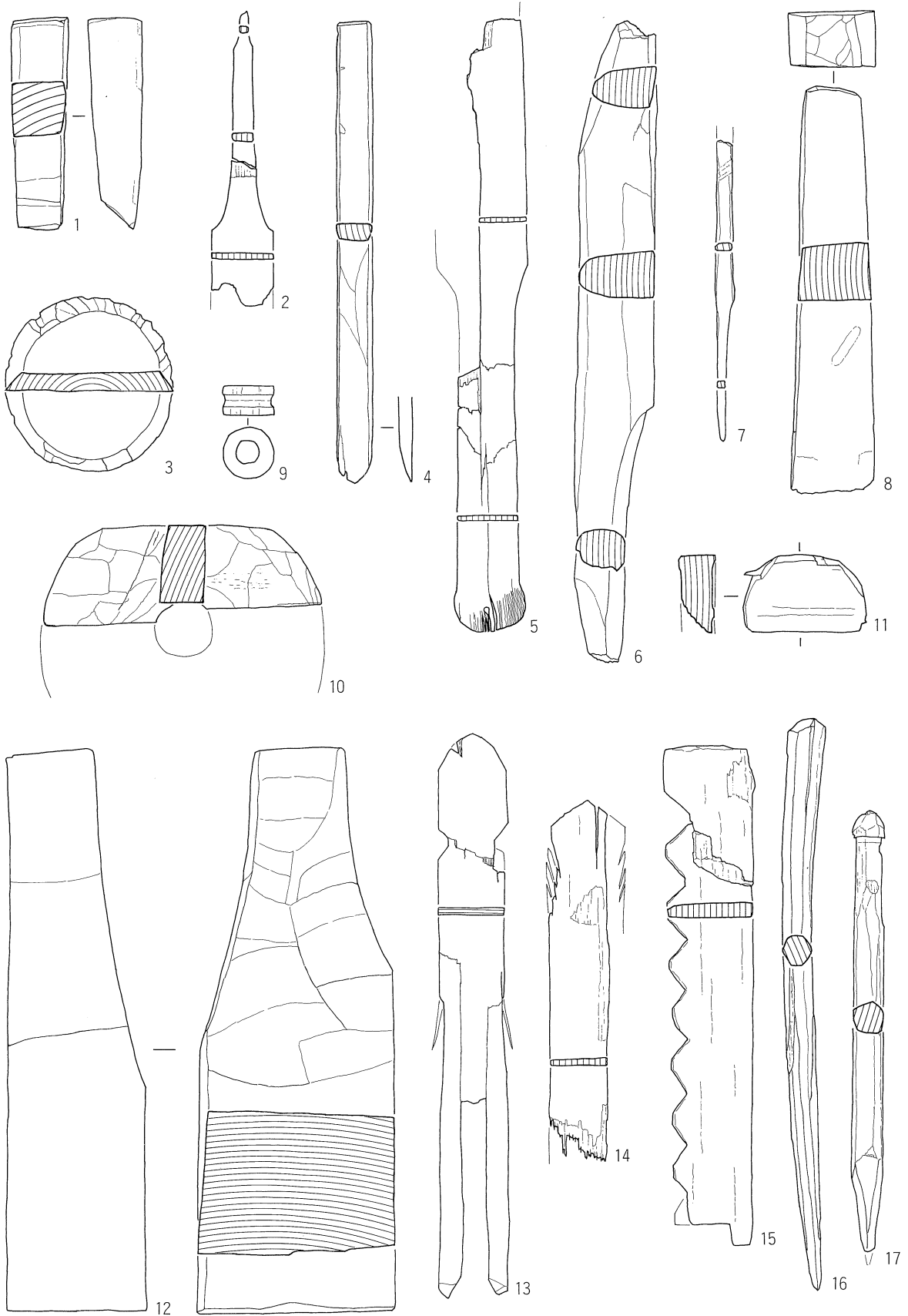

1~12-SD5310

13~17-SD5240

1 : 2

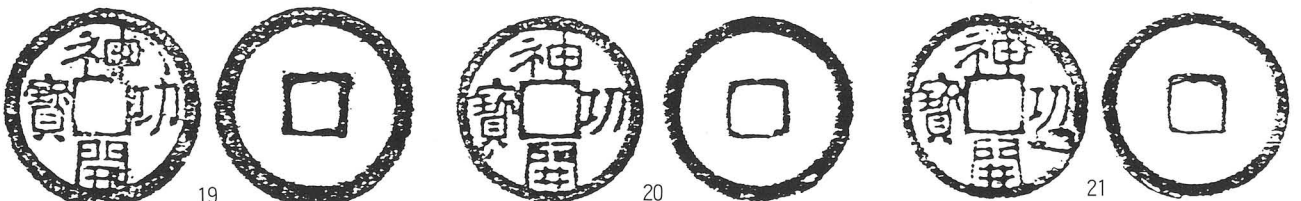
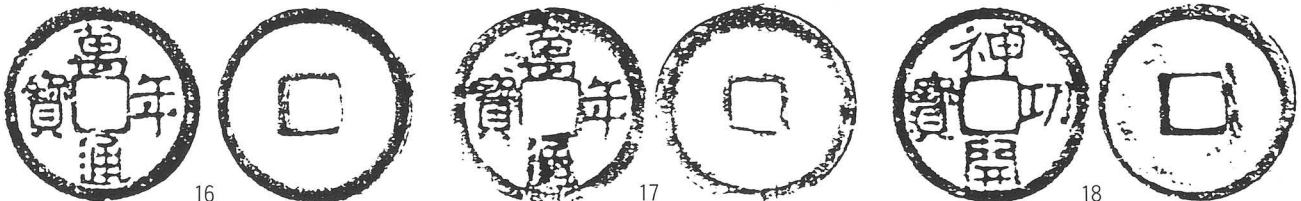
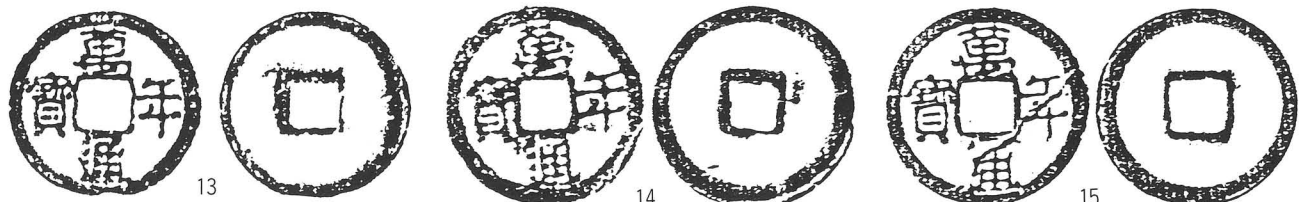
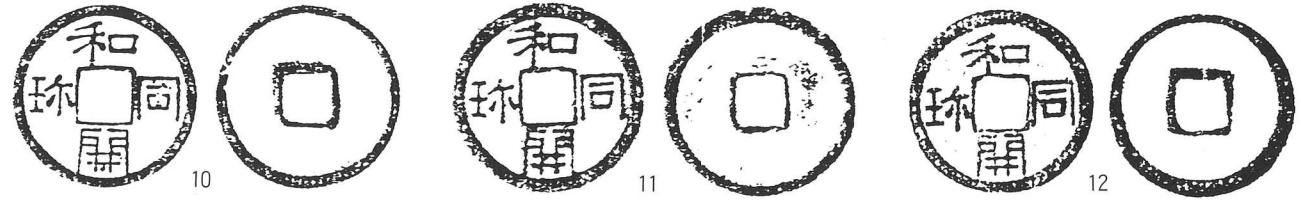
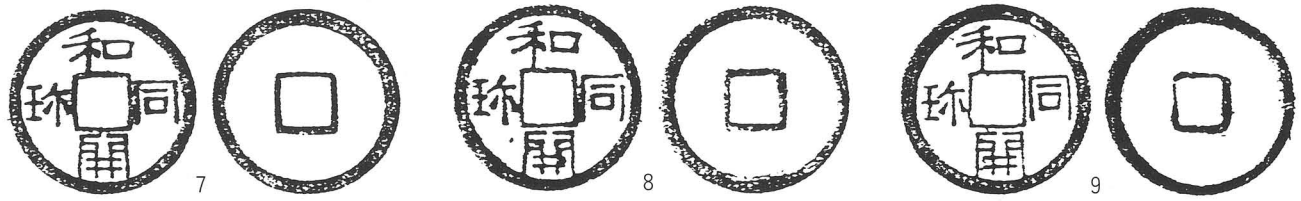
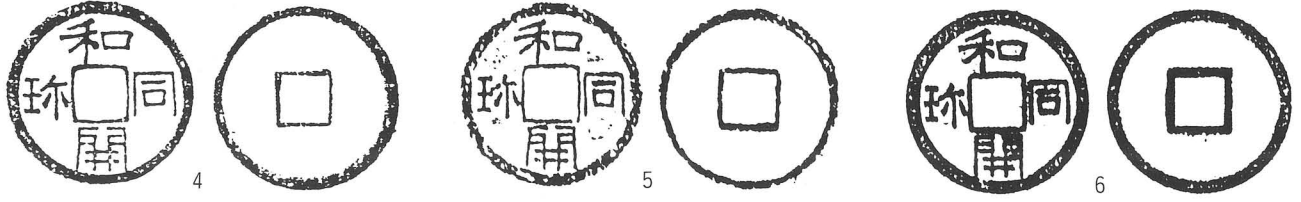
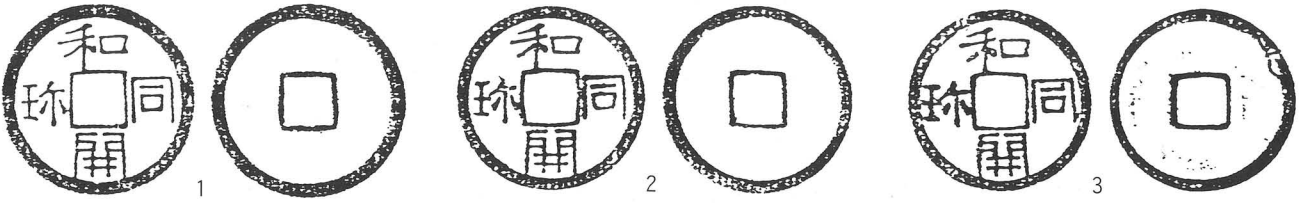

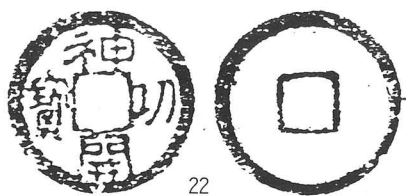

22

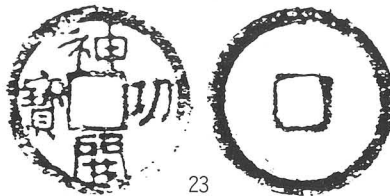

23

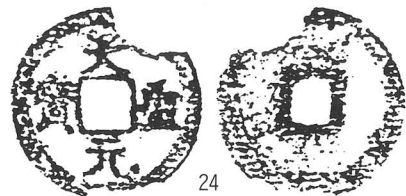

24



25

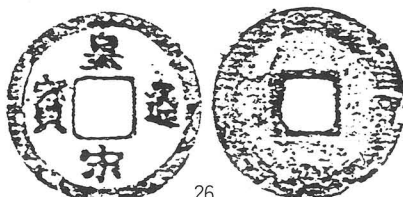

26



27

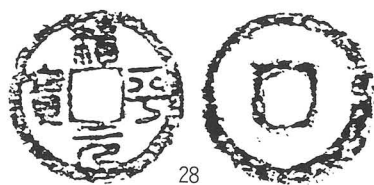

28

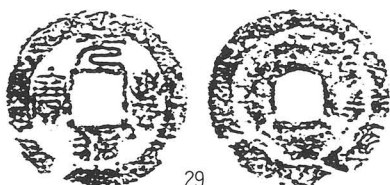

29

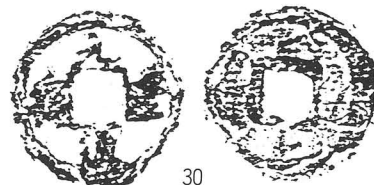

30

1·2·7~11·13·16~18·20·21-SE4580 3-SE5355 4·12-SD5021 5-SD4750 6·15-SD4699
 14·19-SD5240 22·23-SE4580 24~30-包含層他

1:1

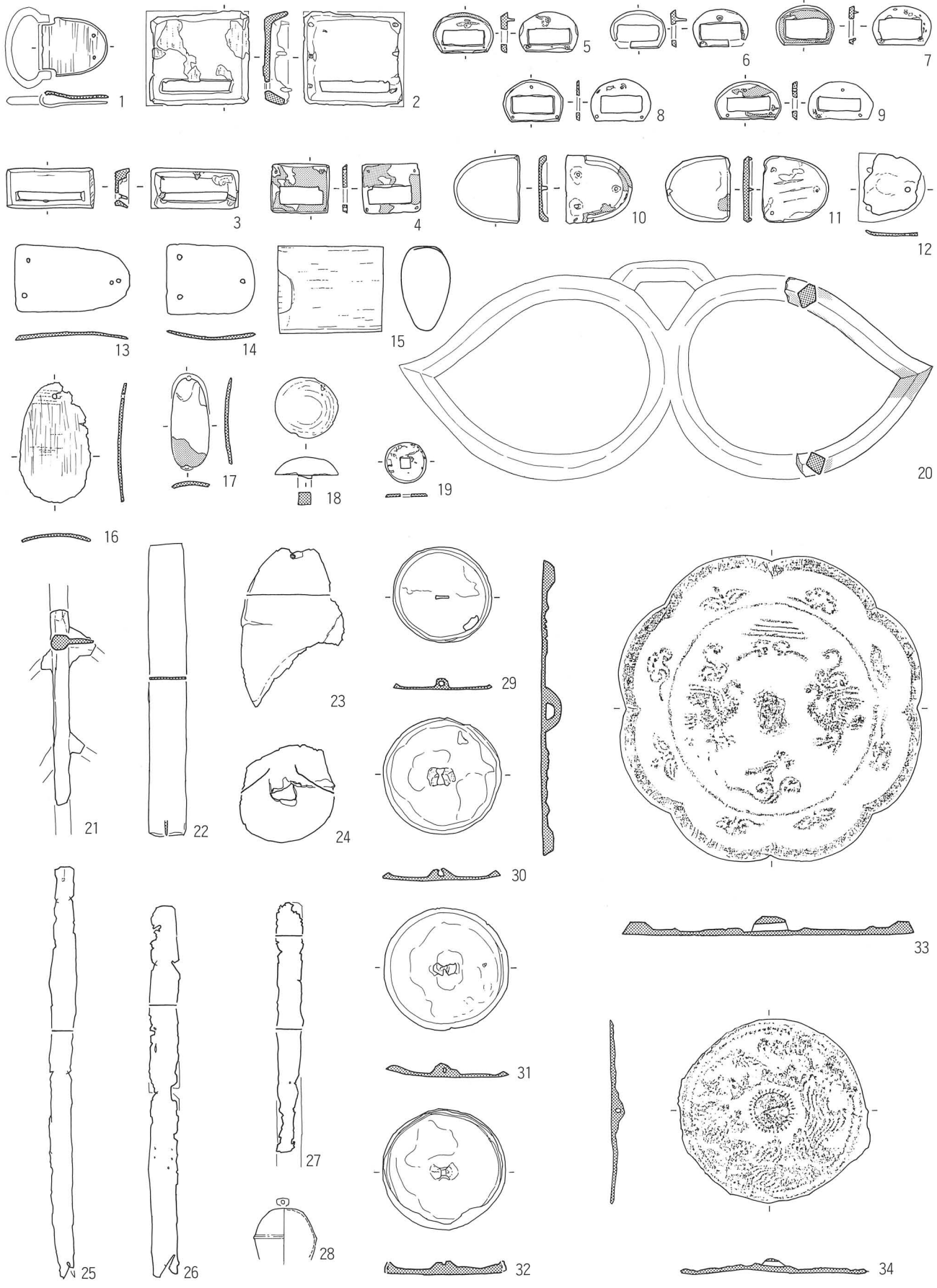

1・31-SD4699

2-SD4359

3・18-SE4580

4・19-SD5021

5・6・15・20・25~27-SD5100

7・9~11・7-SD5300

8・33-SD5240

12-SE5075

13・14・16-SD4361

21・22-包含層

23・24-SD4750

28-SD4231

29-SE4365

30-SD1450

32-SK4545

34-SK3497

1 : 2

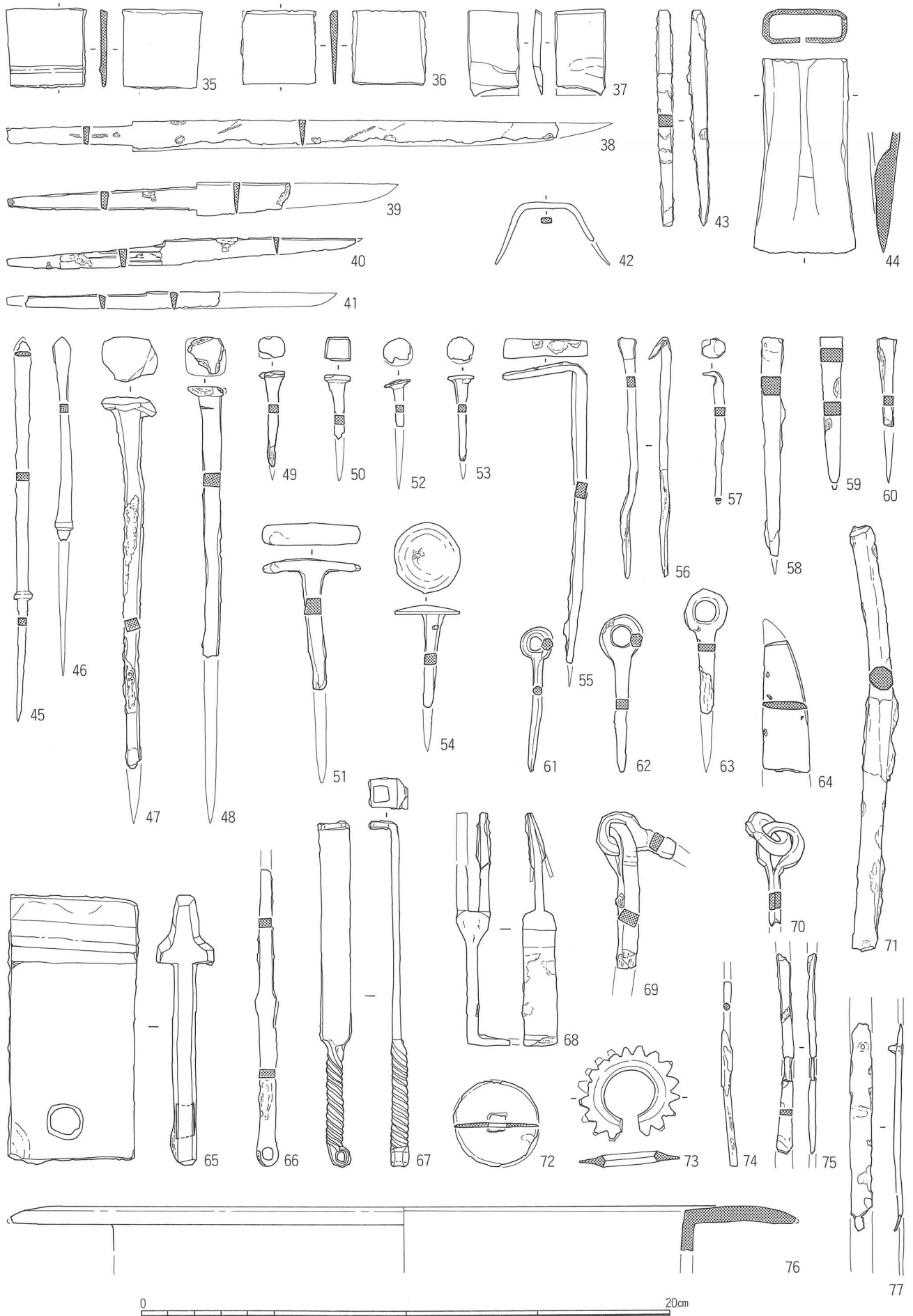

35・36・38・41～43・8・48・51・56・60・68～70・72・73・75-SD5300 37・71・76-包含層 39-SE5205 40・47・65・67-SD4699
 44-SE5355 45-SE4770 46・58-SE4225 49・53・57・59・62-SE4580 50・52・64・66・74-SD5100 54-SE5220
 55-SE5140 61-SE4366 63-SK5074 77-SD4750 1:2

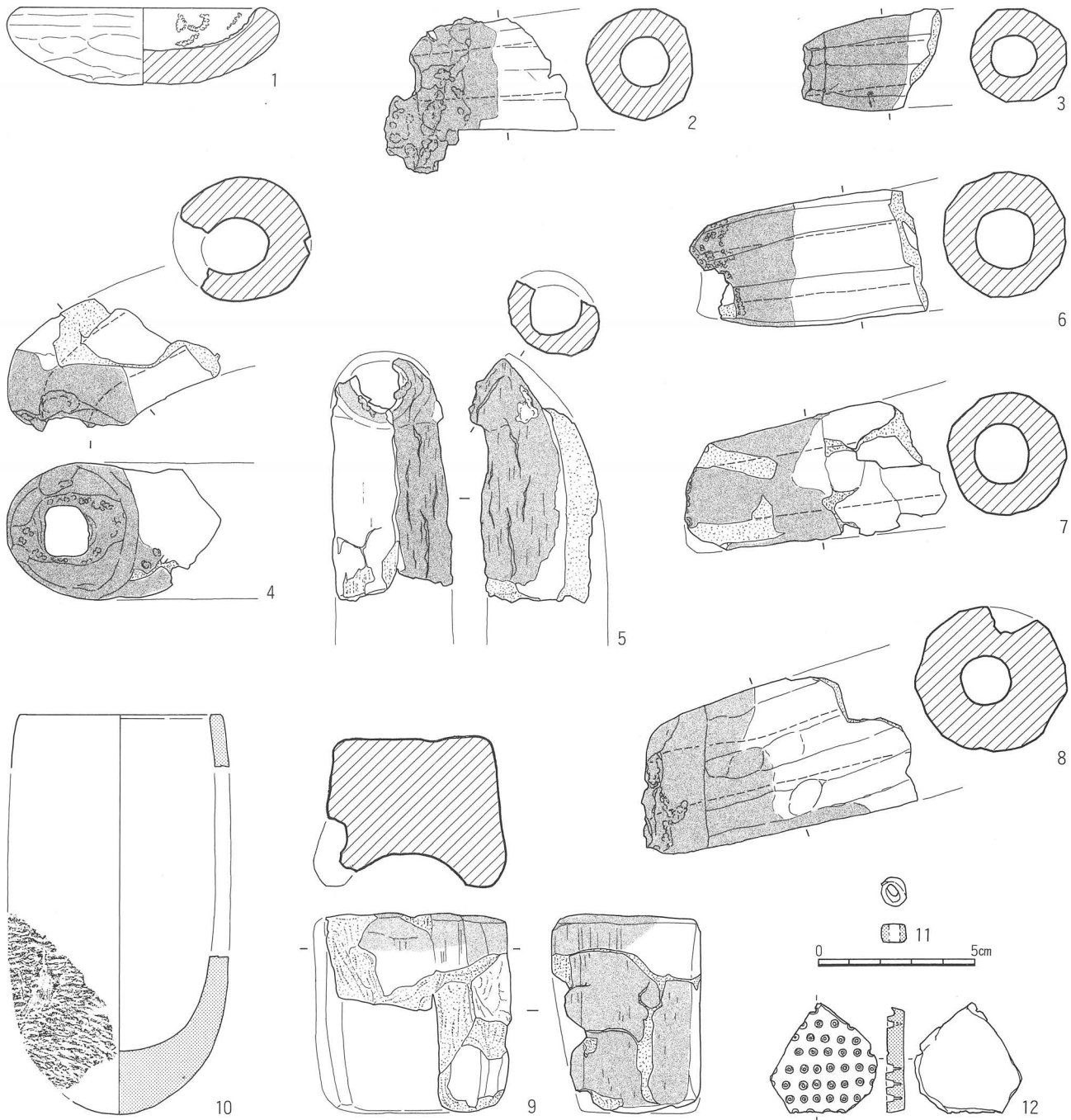

0 20cm

1・7・12-SD5100 2・8-SD5300 3・4・6-包含層 5・9-SX4495 10-SD4150 11-SD4750
 11 1:2 1~10・12 1:3

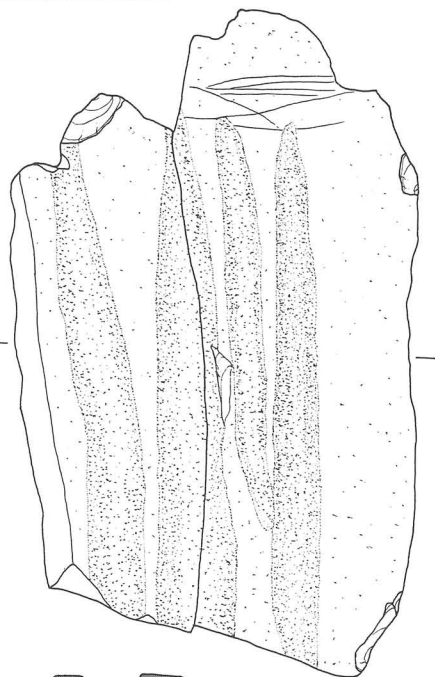
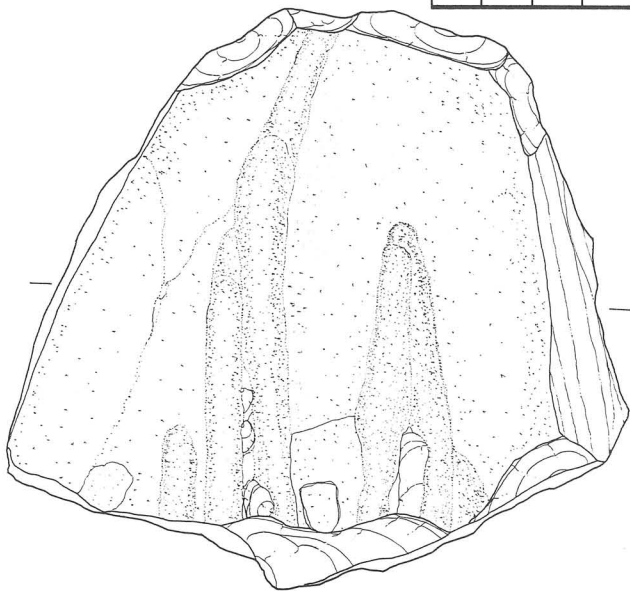
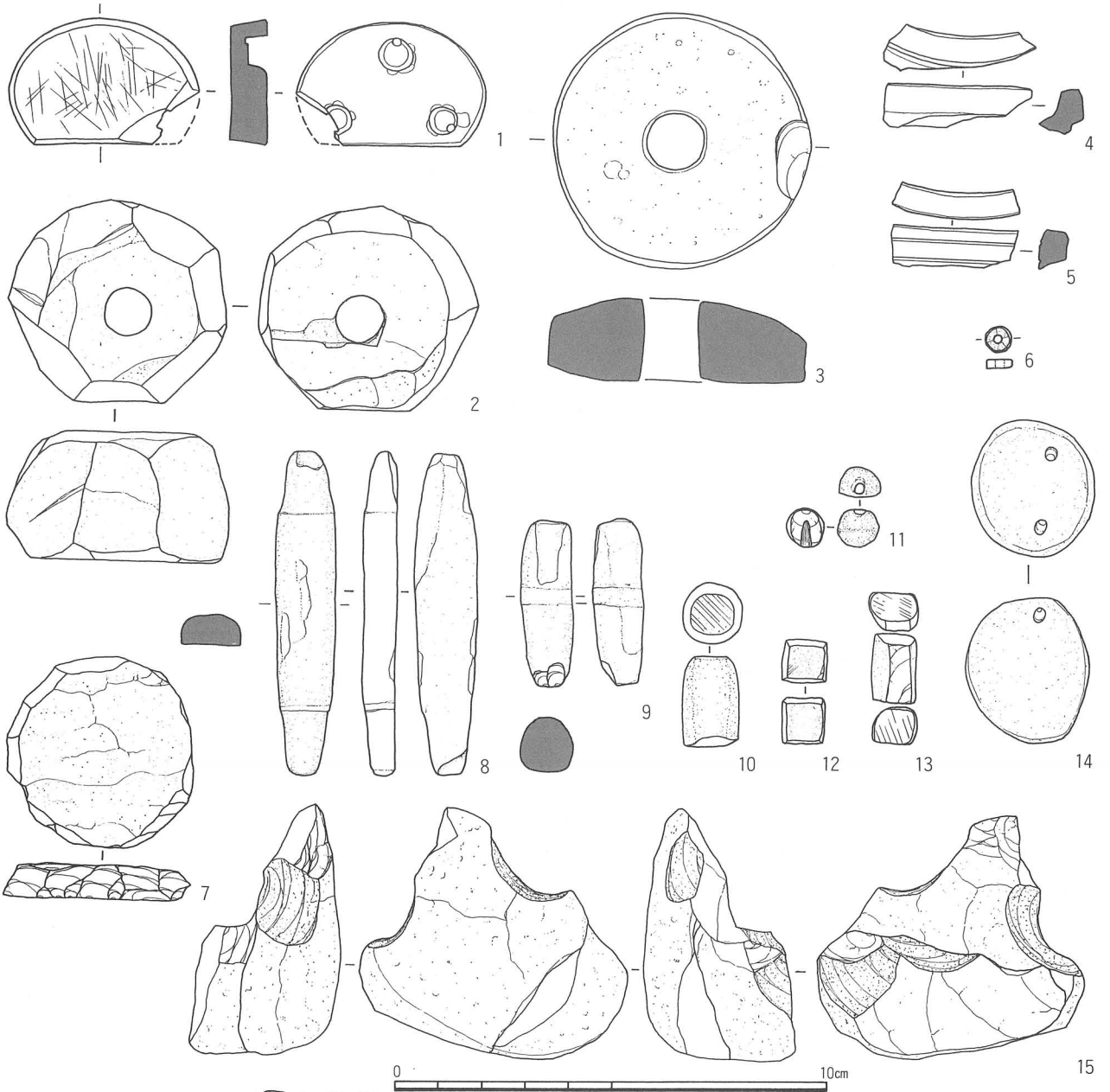

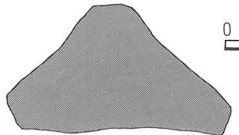
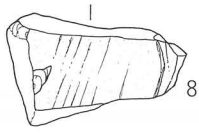
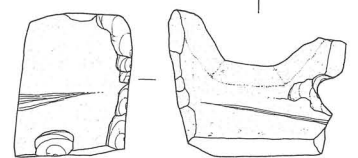
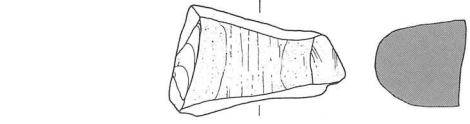
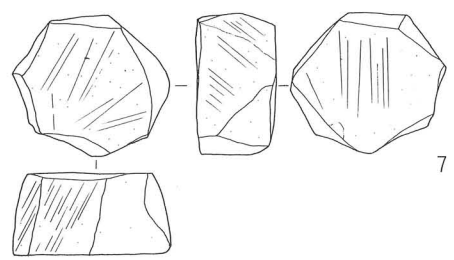
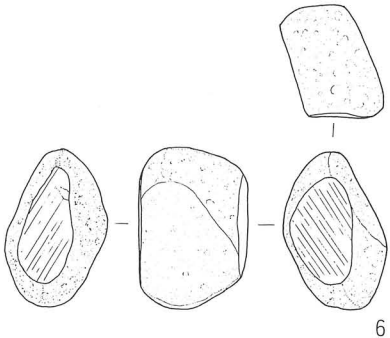
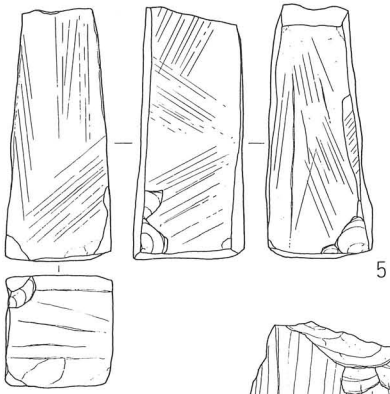
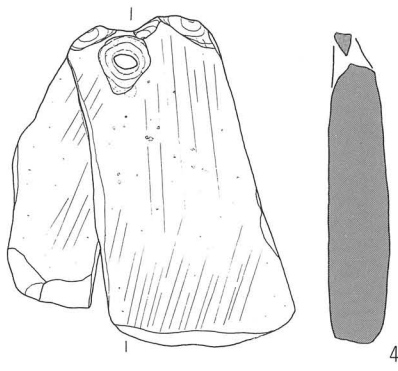
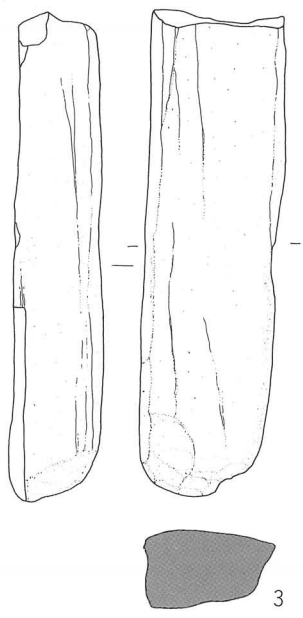
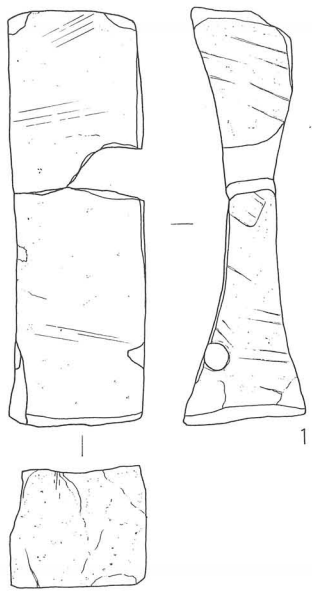

0 10cm

0 20cm