

# 圖 面

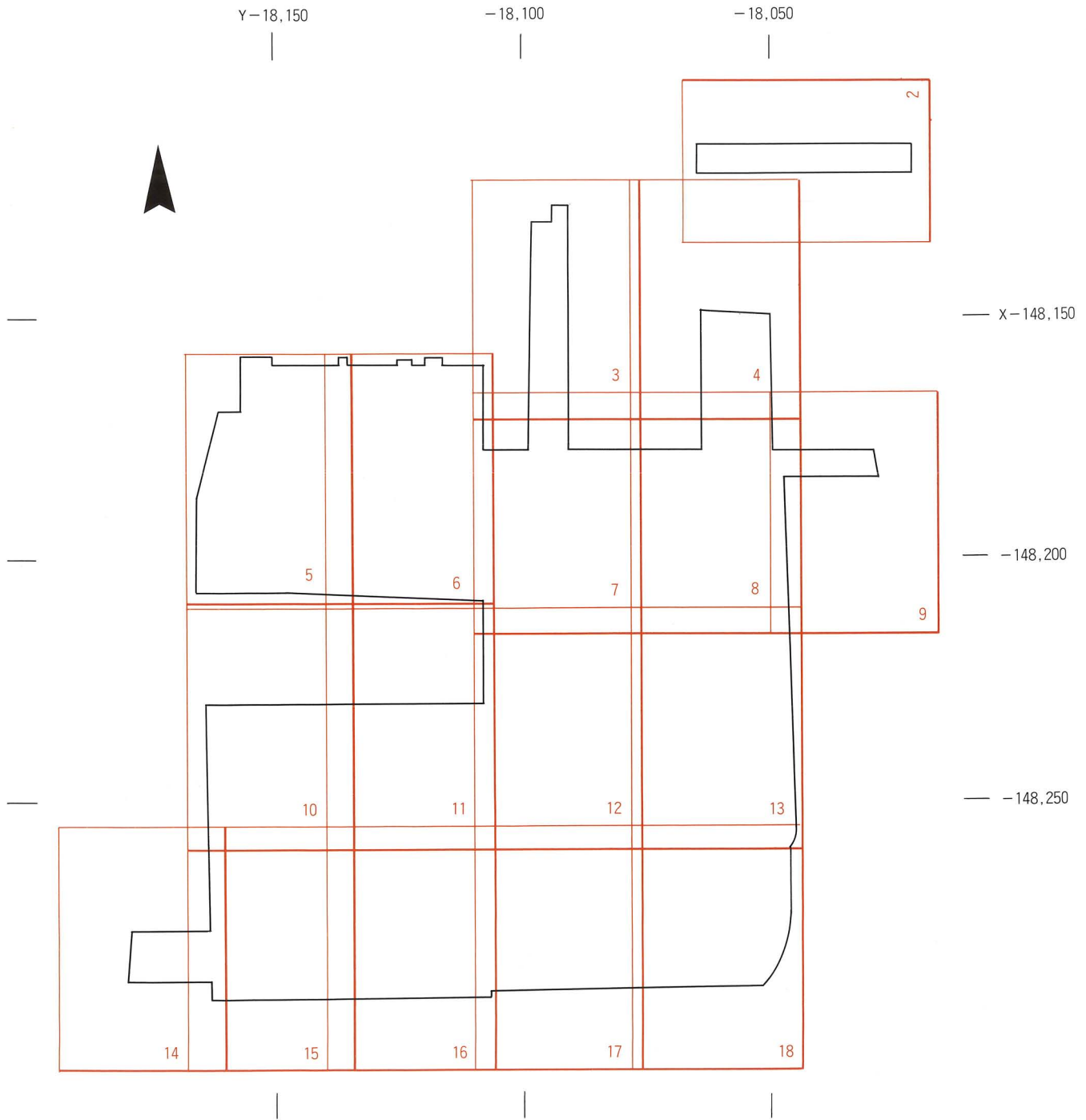

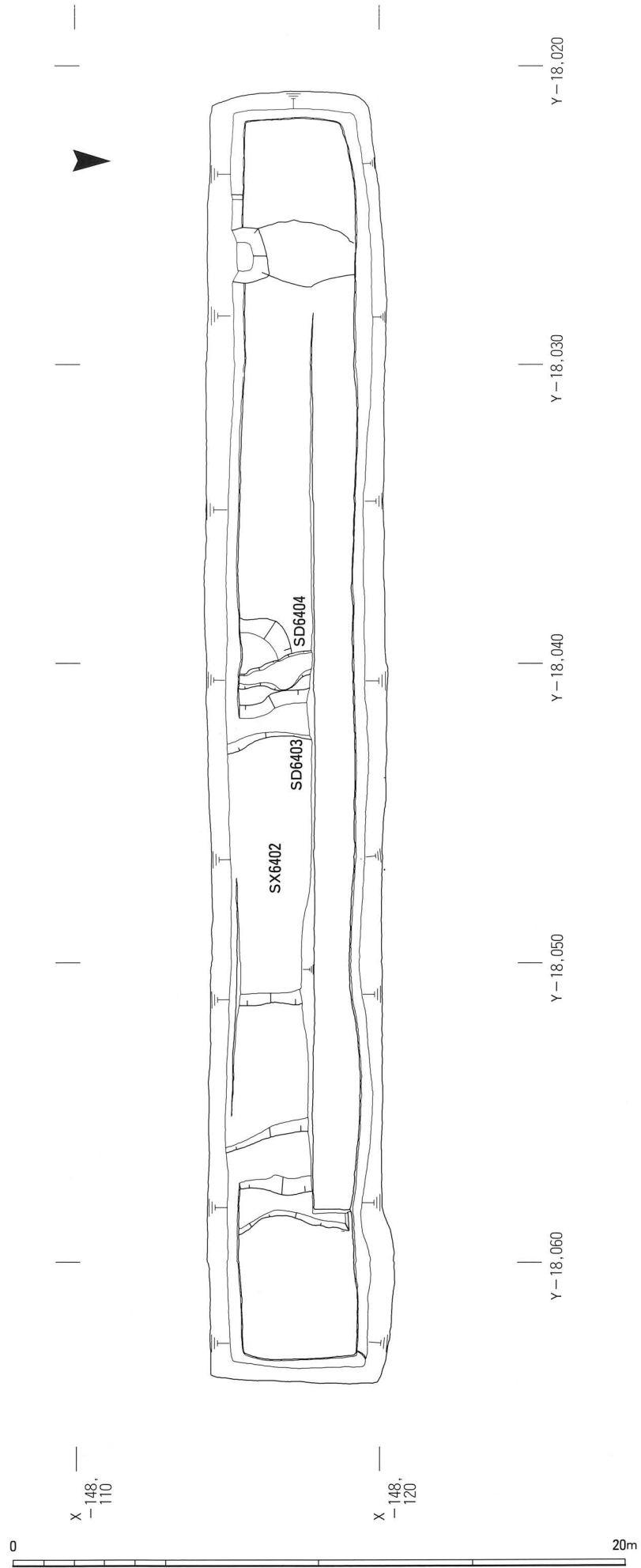

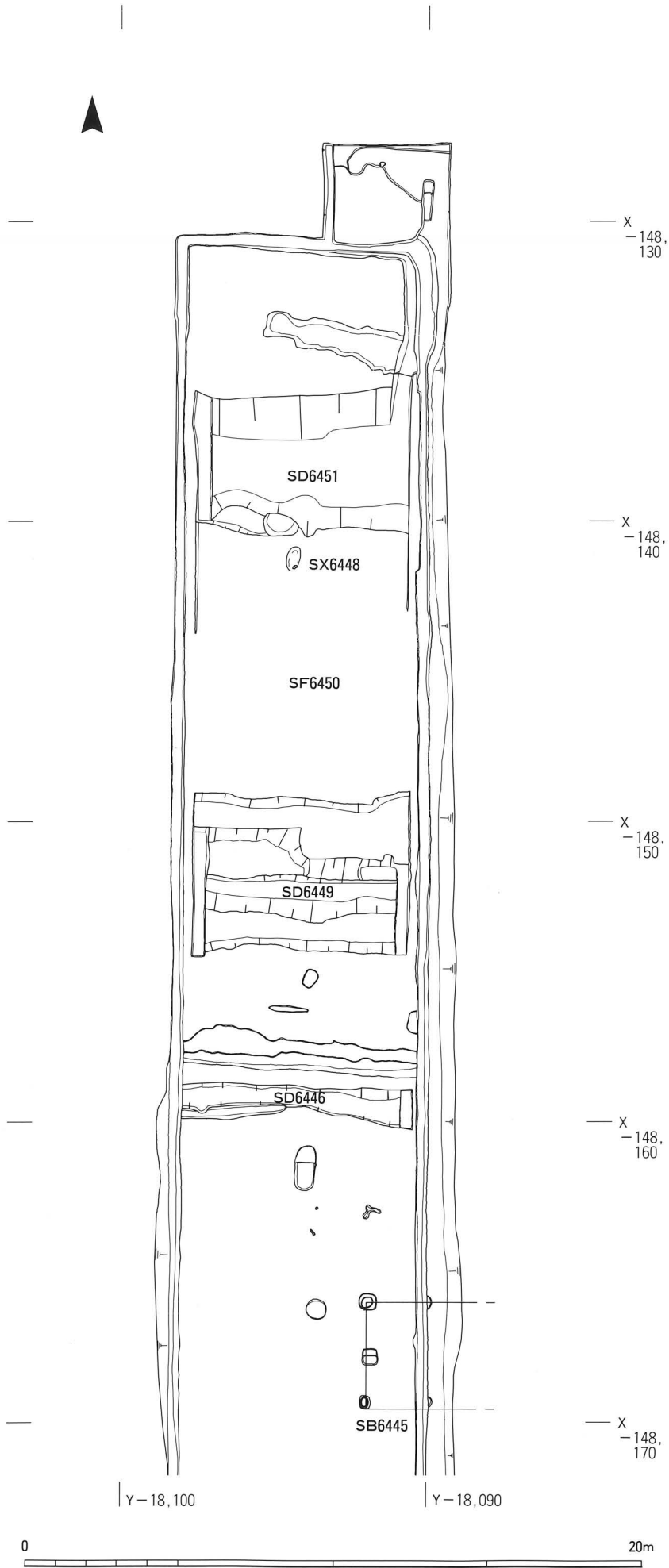

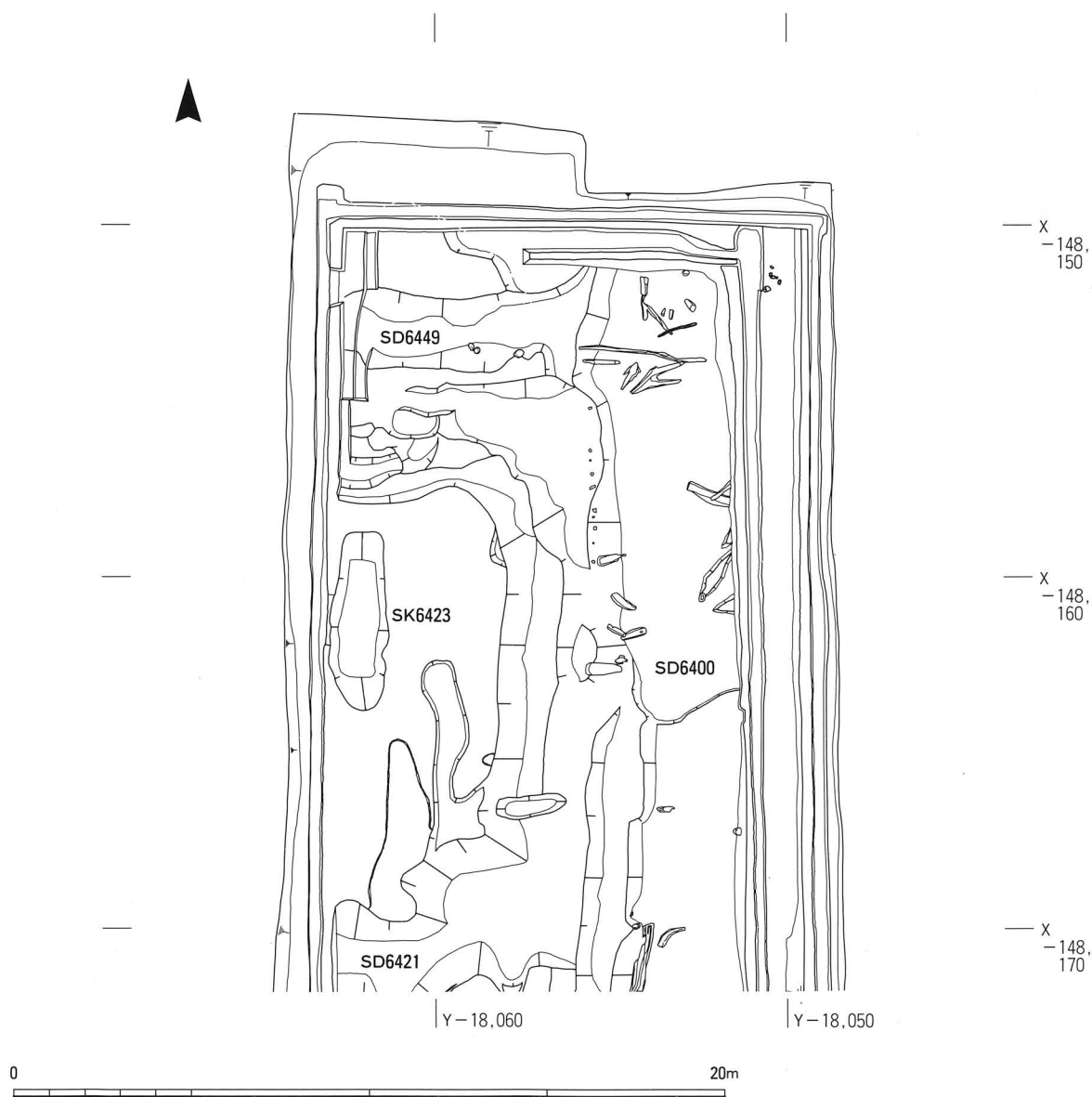

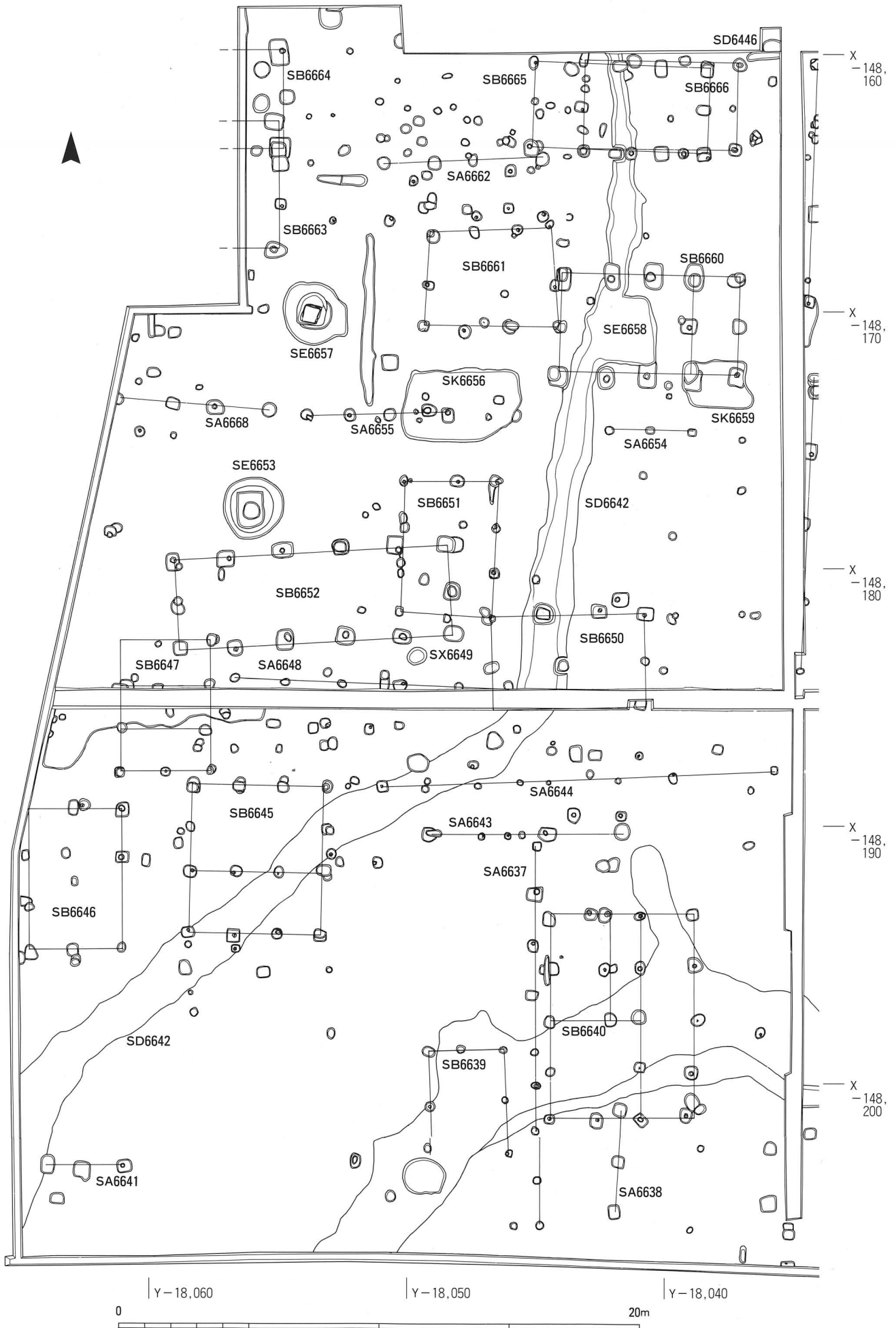

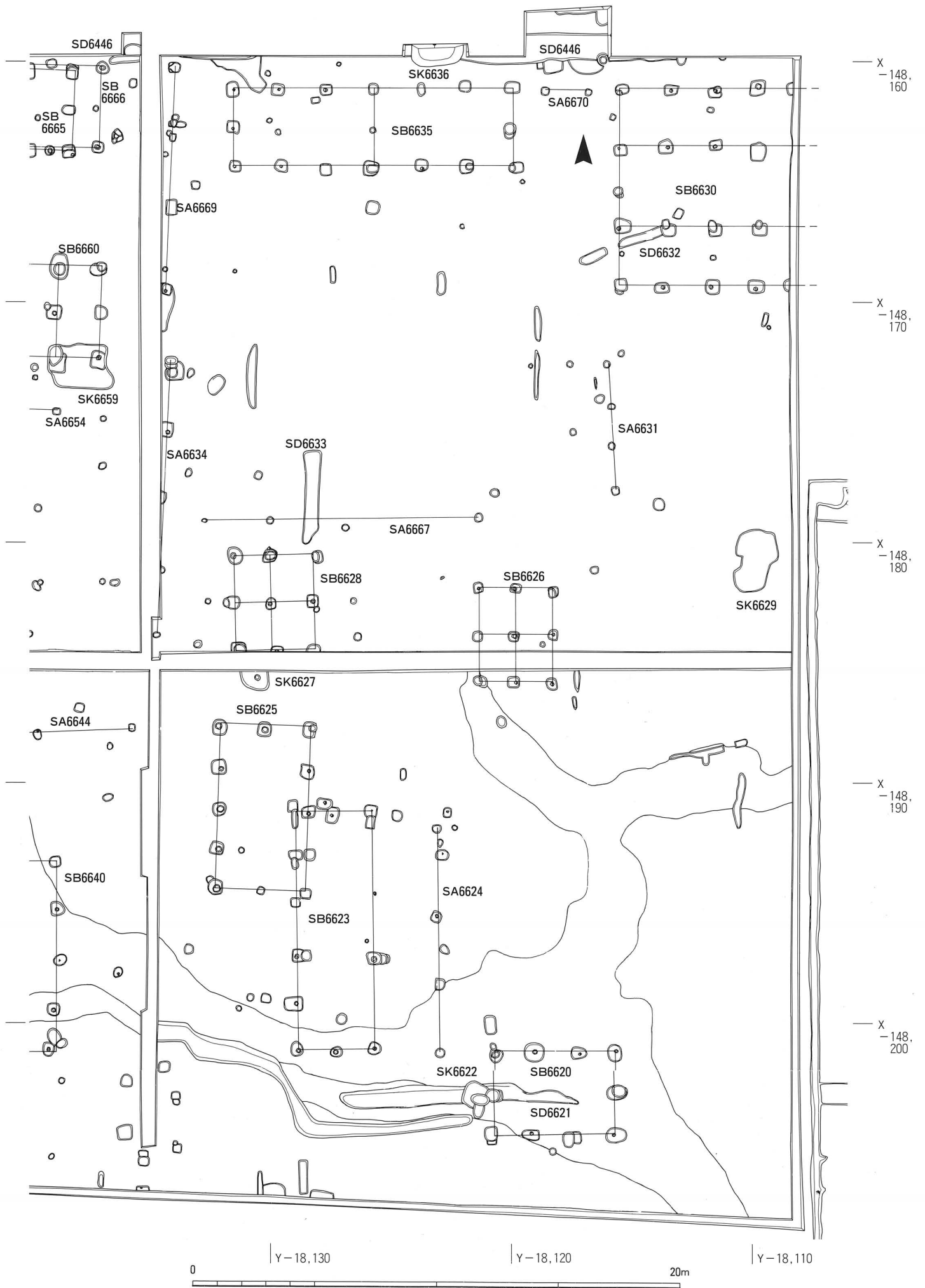

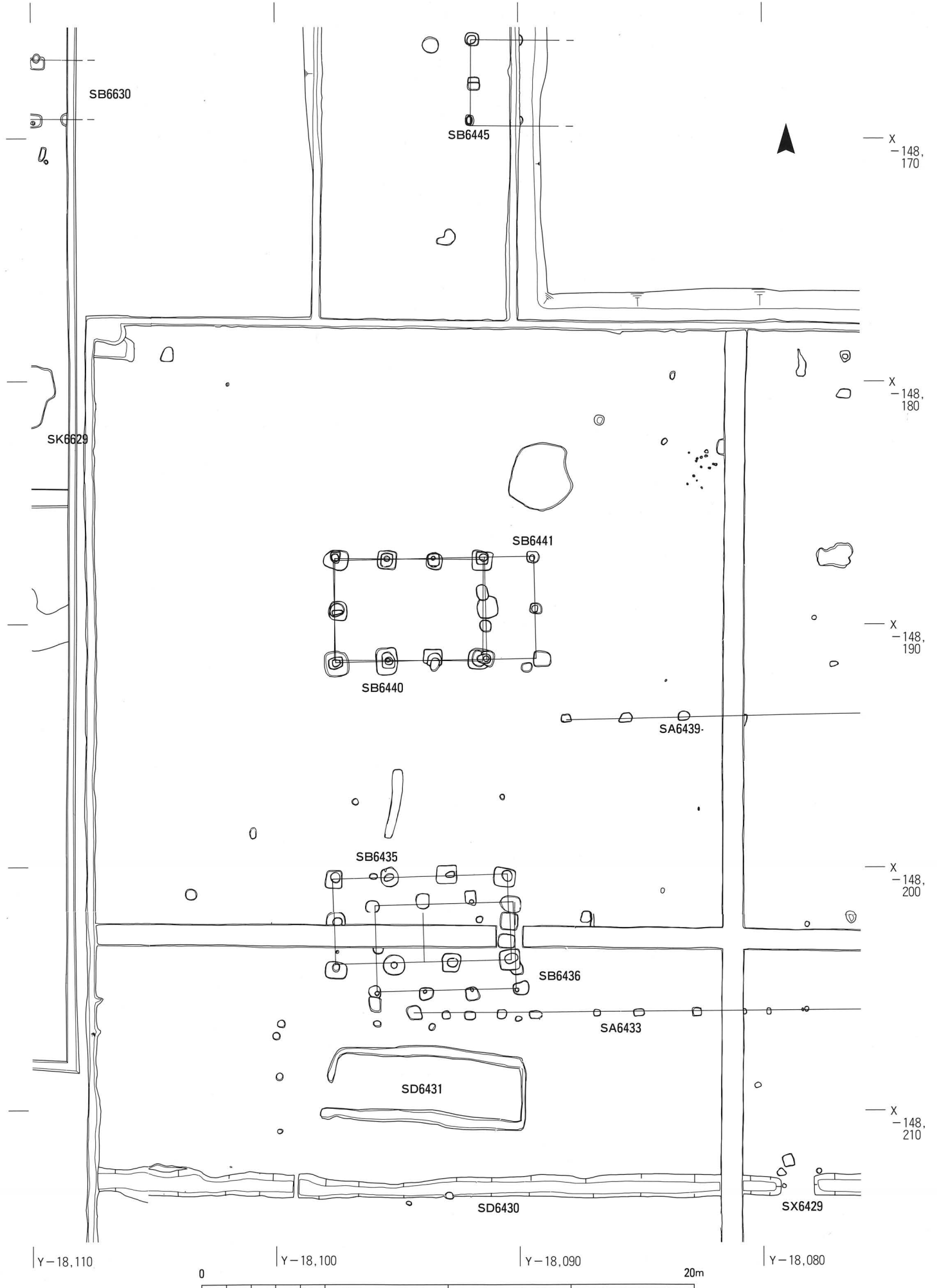



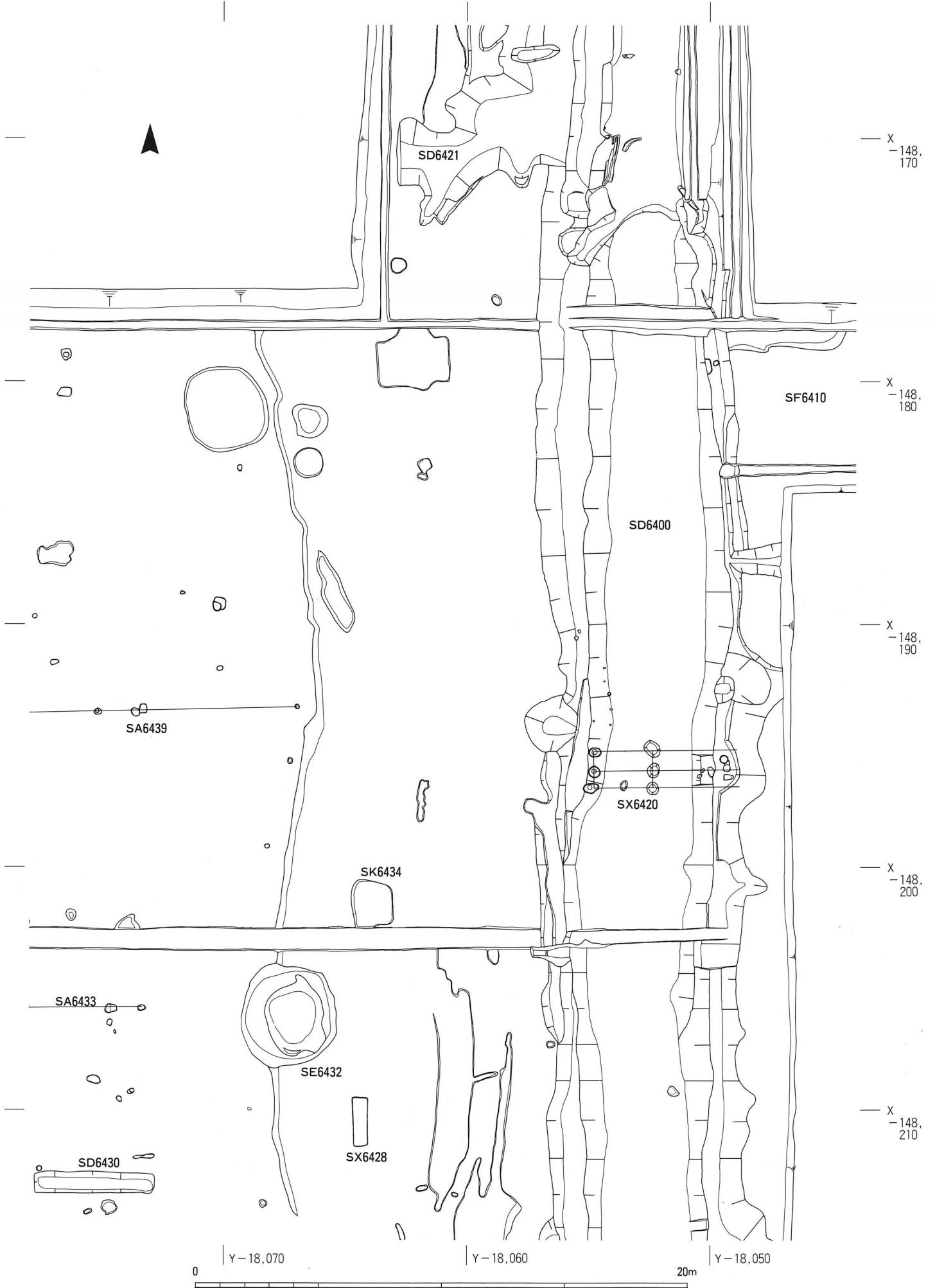

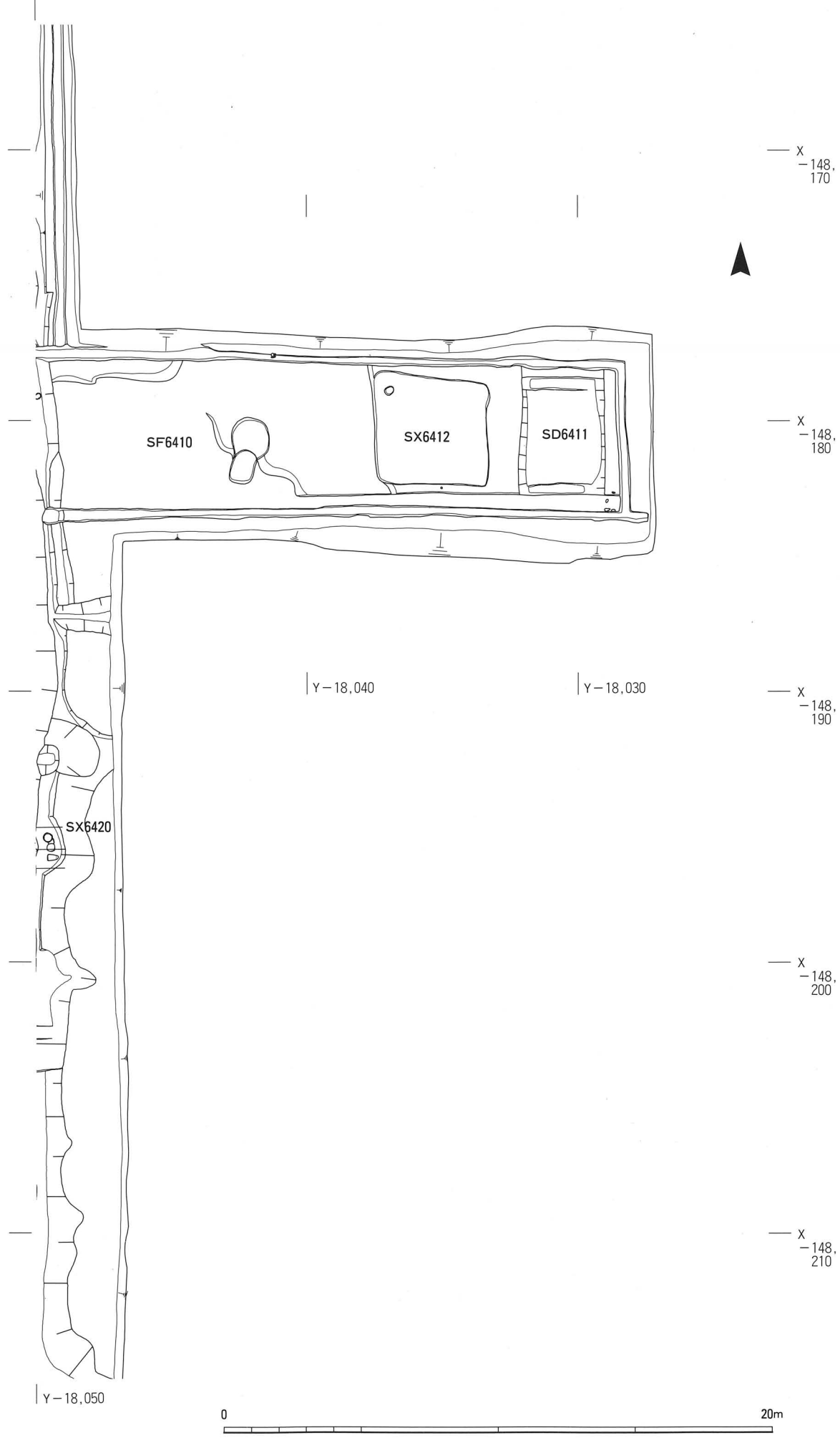

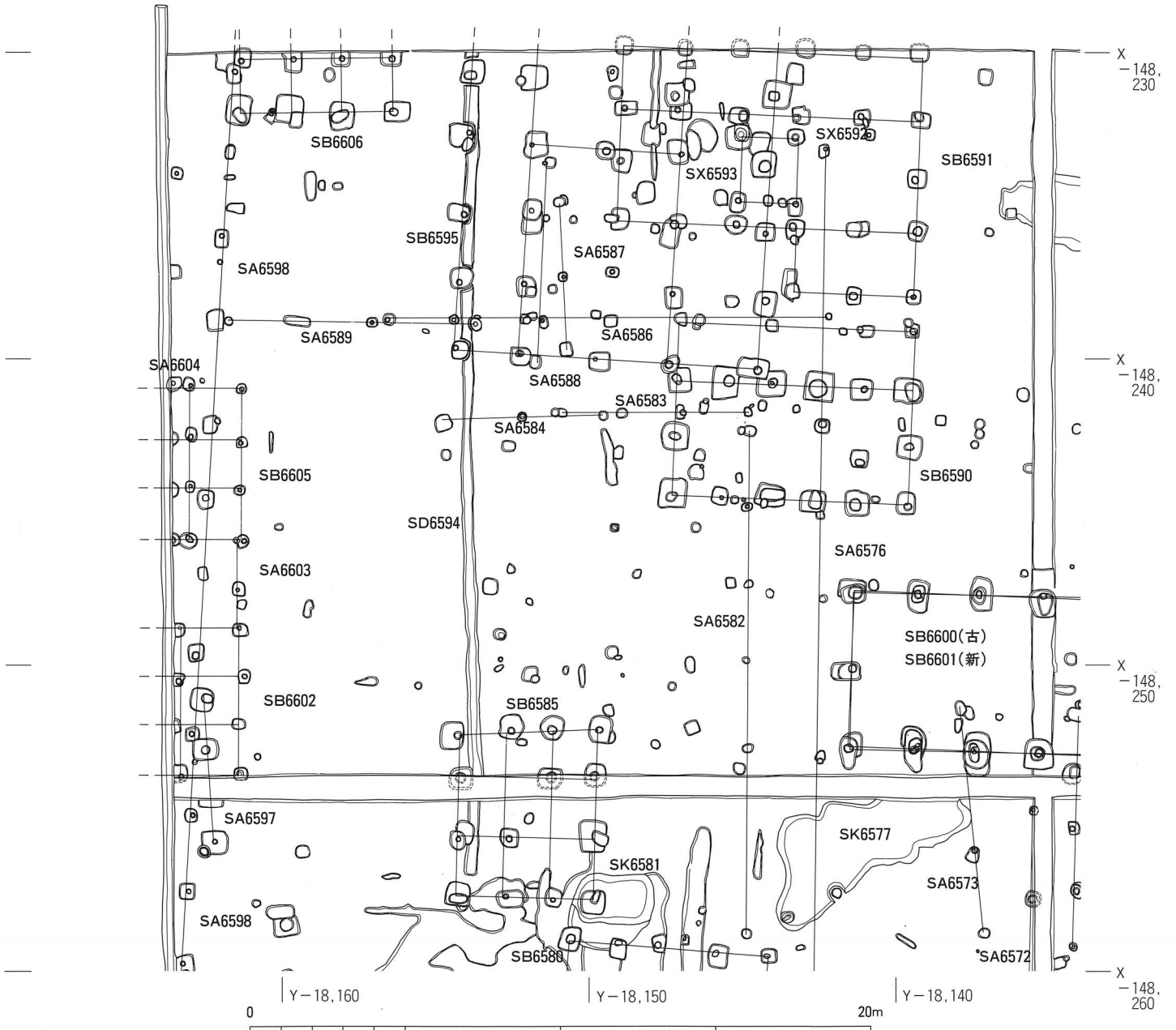



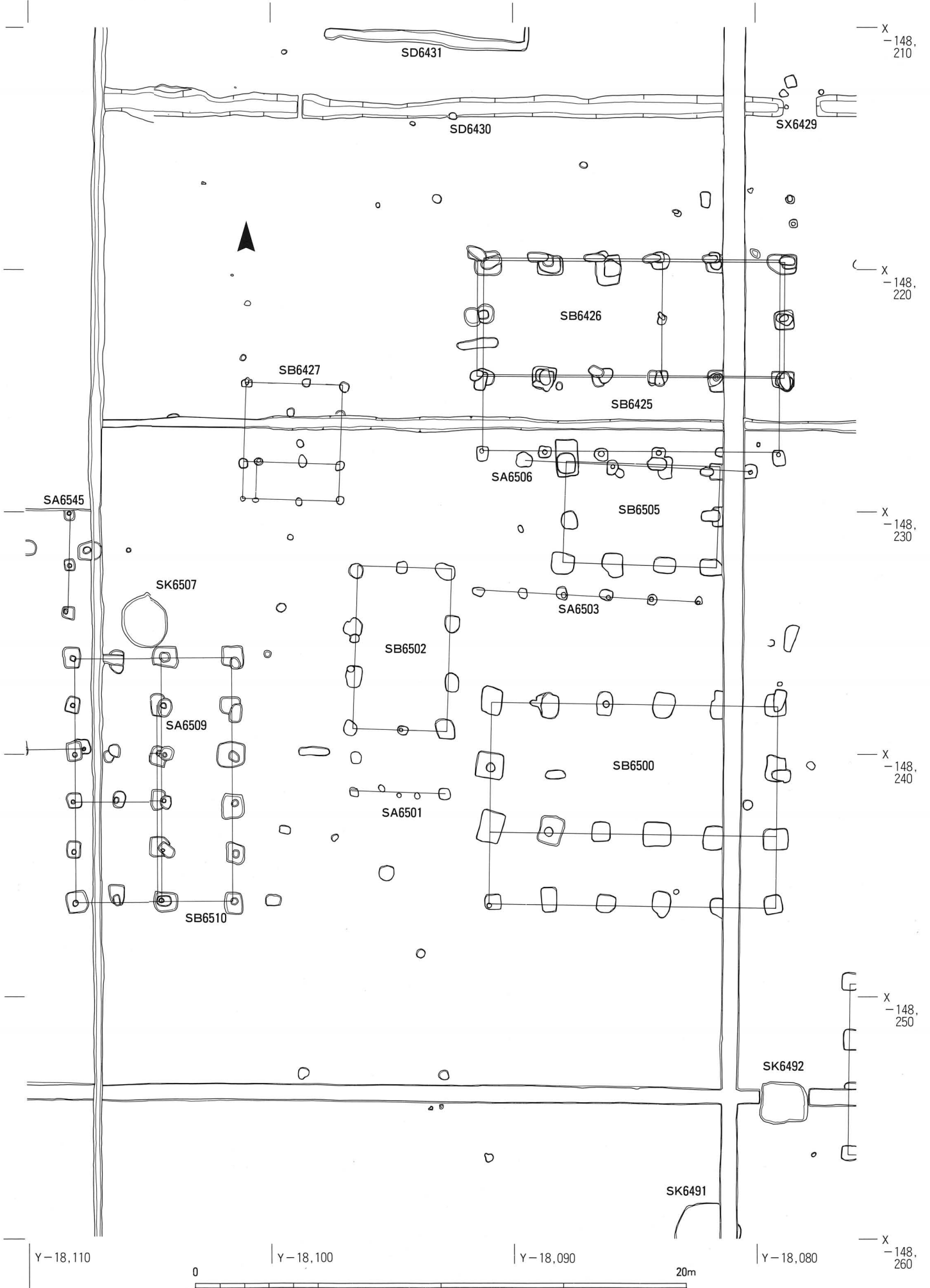

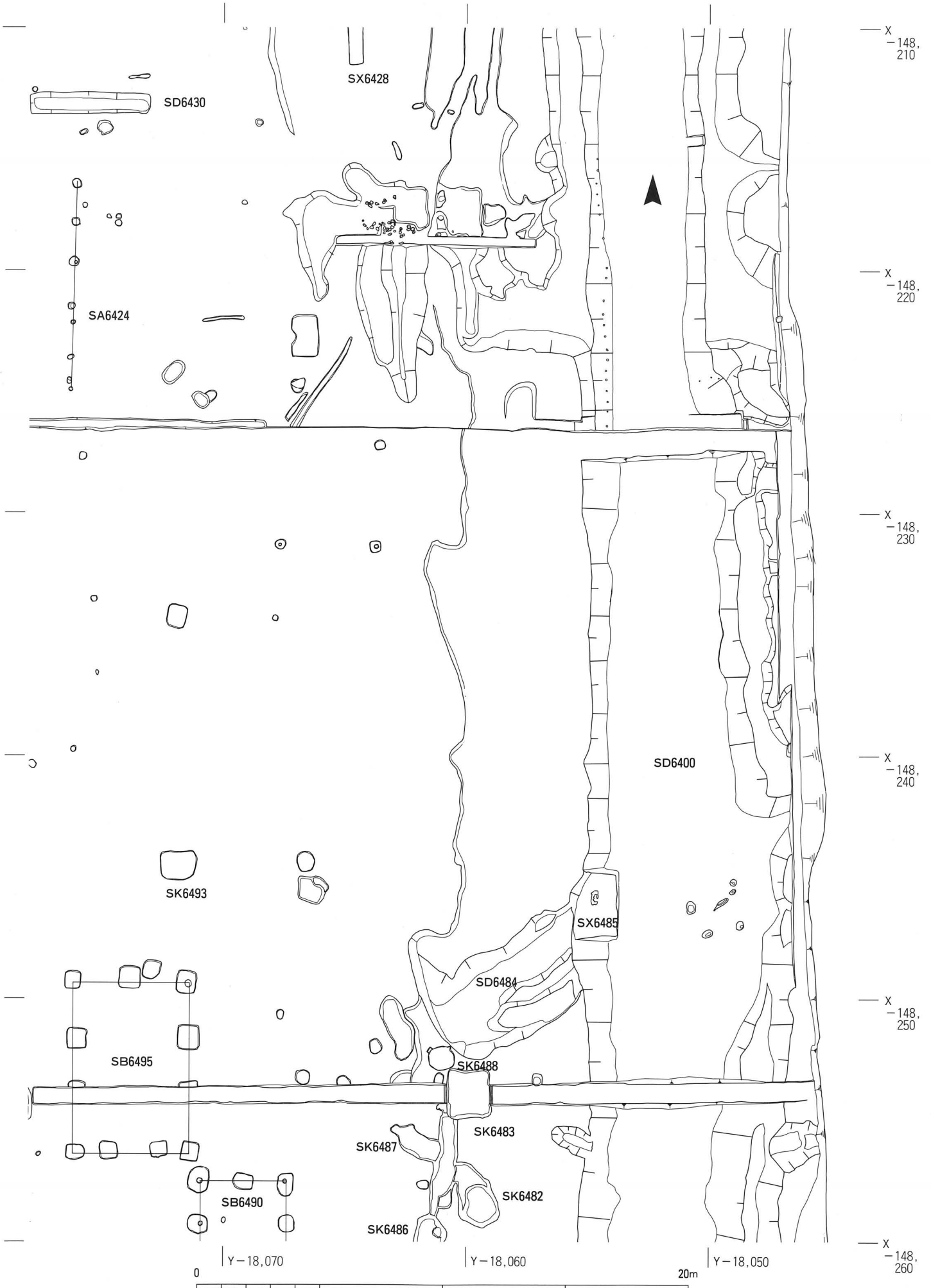

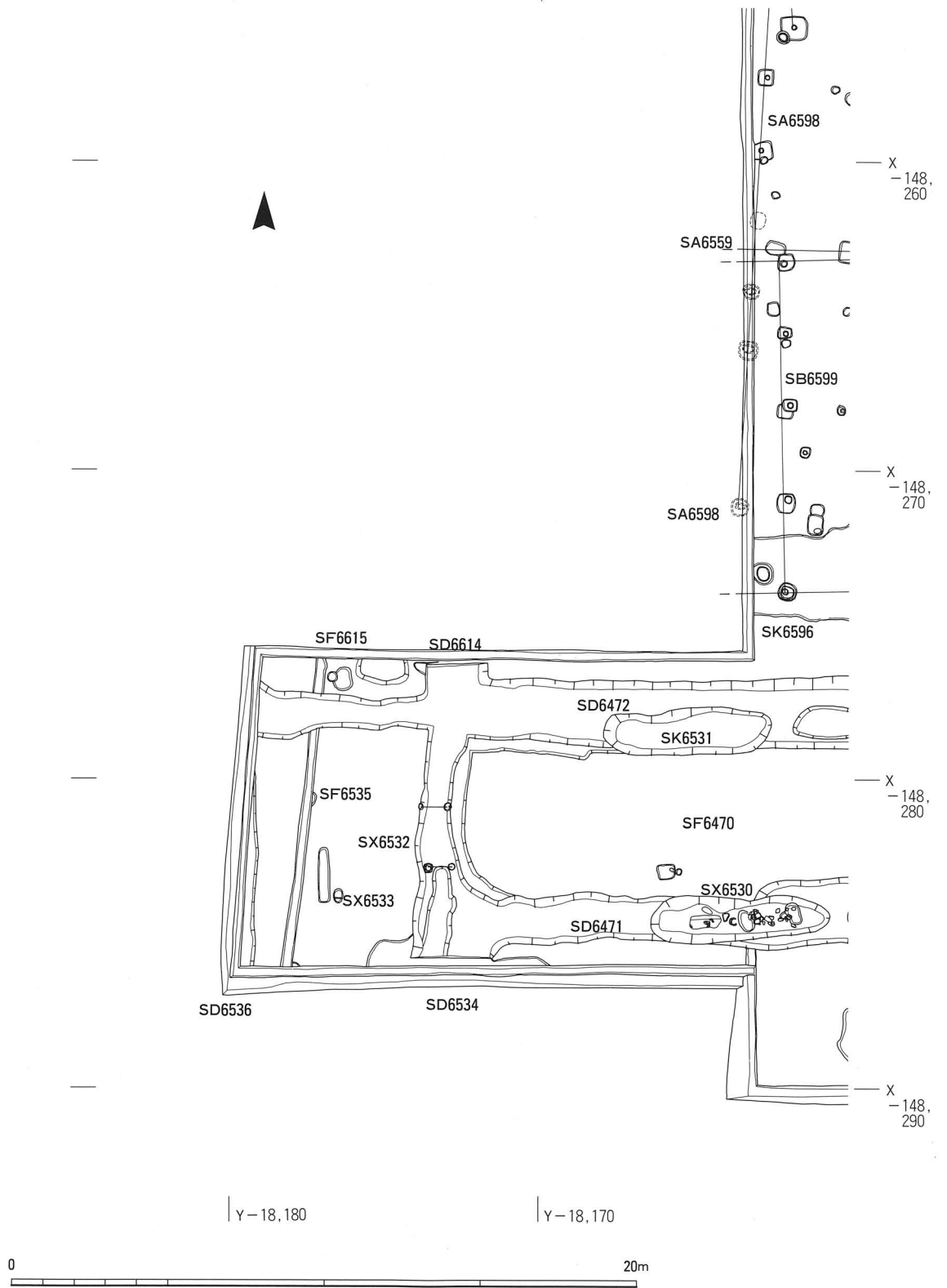

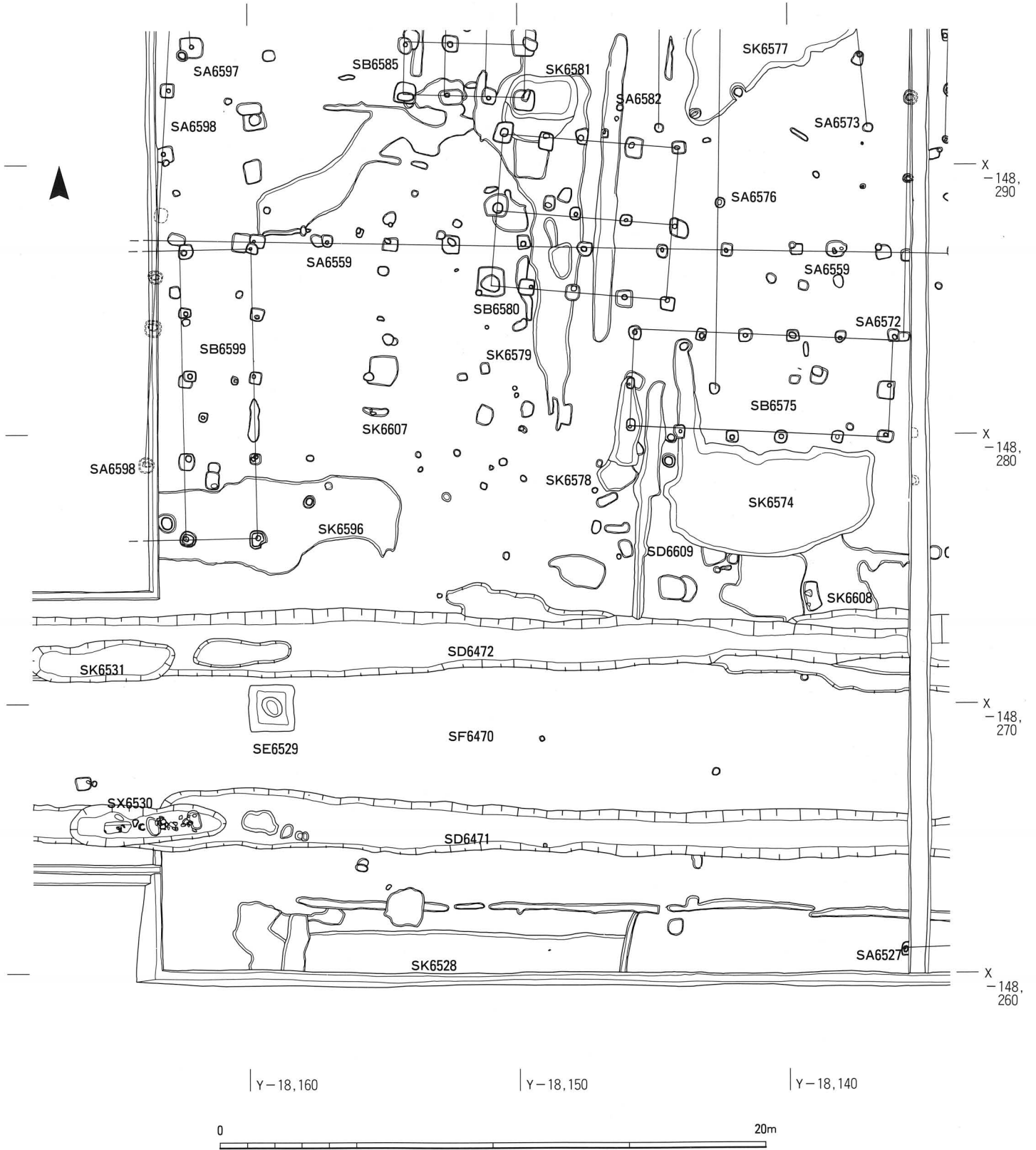



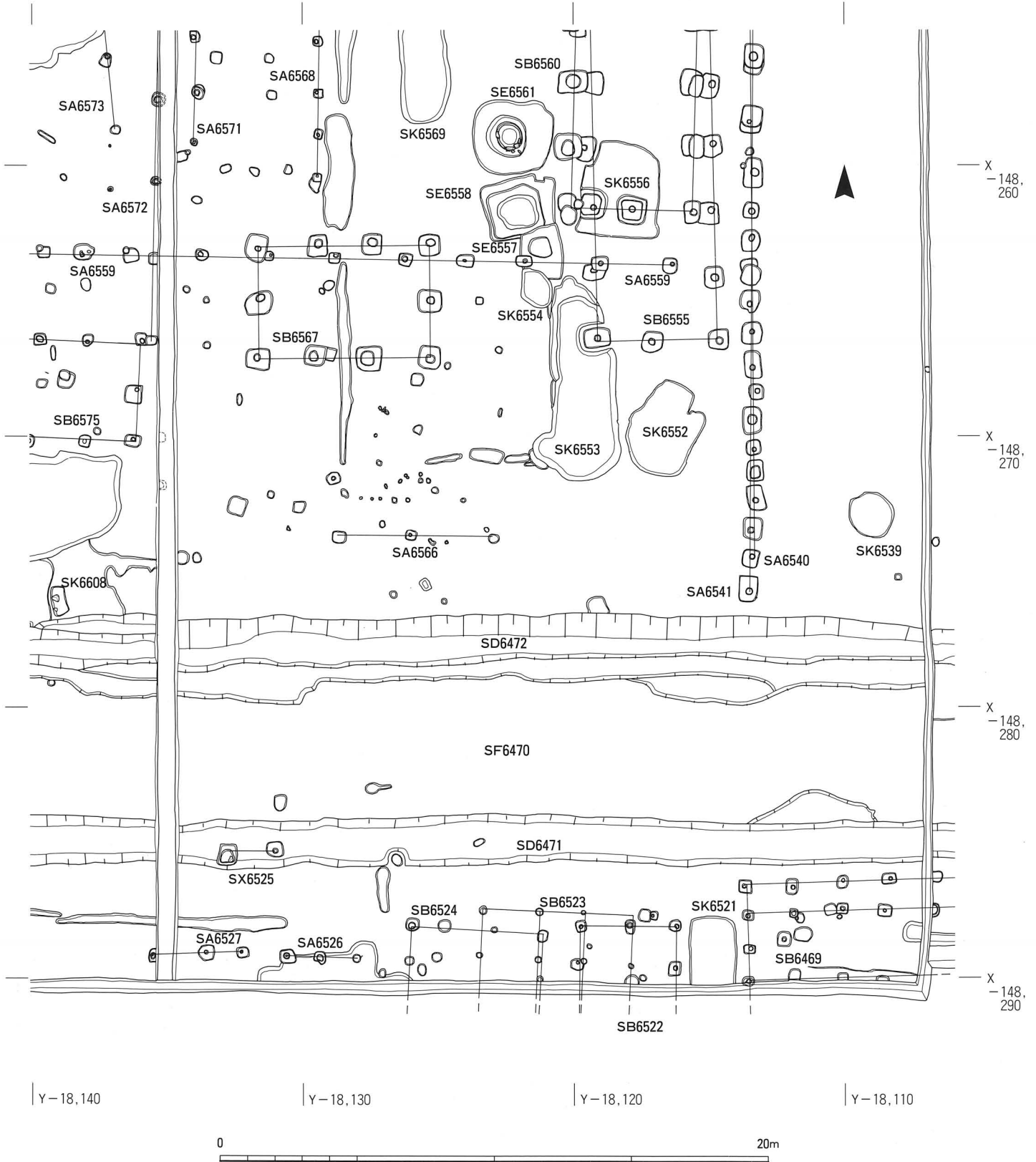

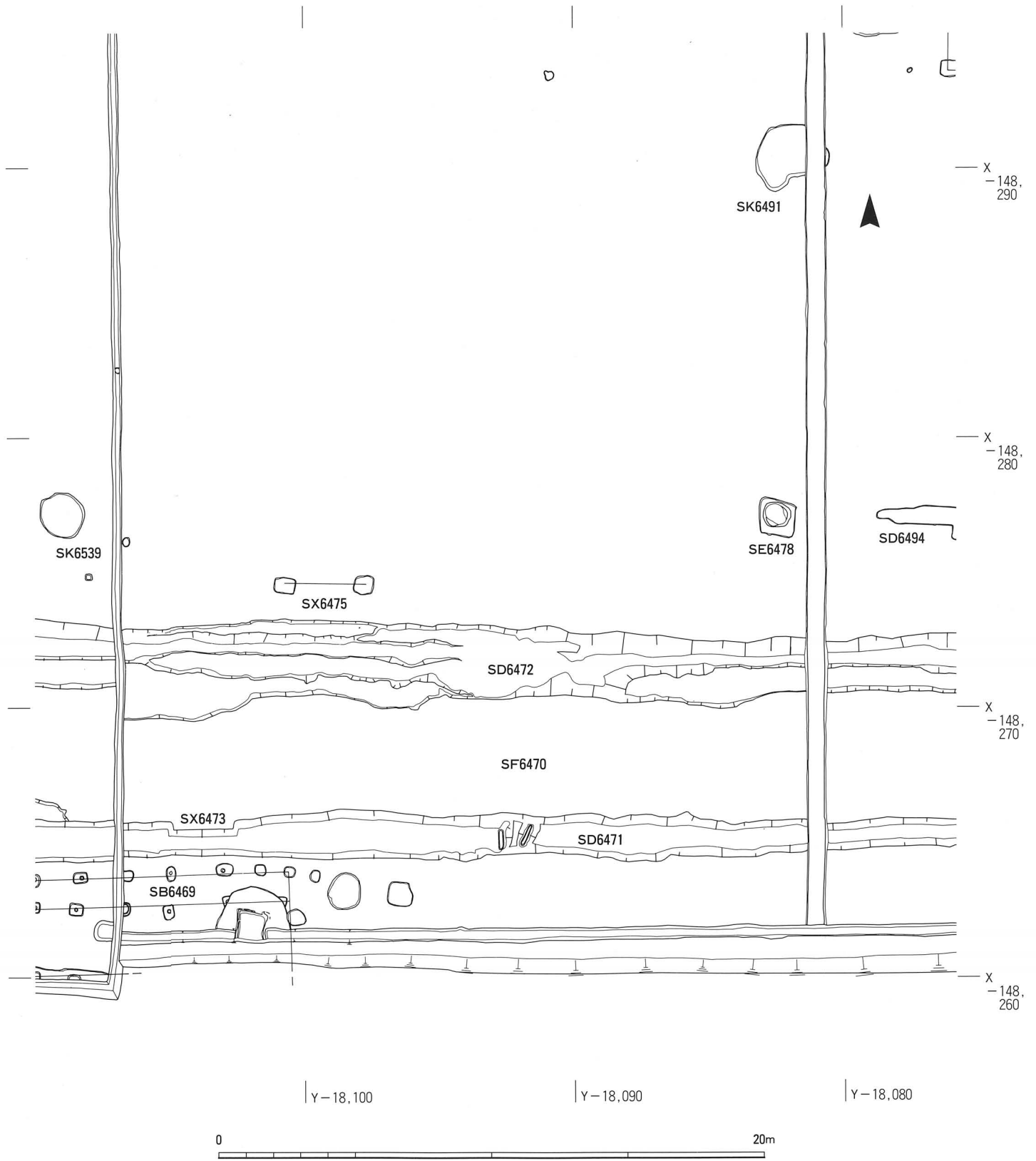

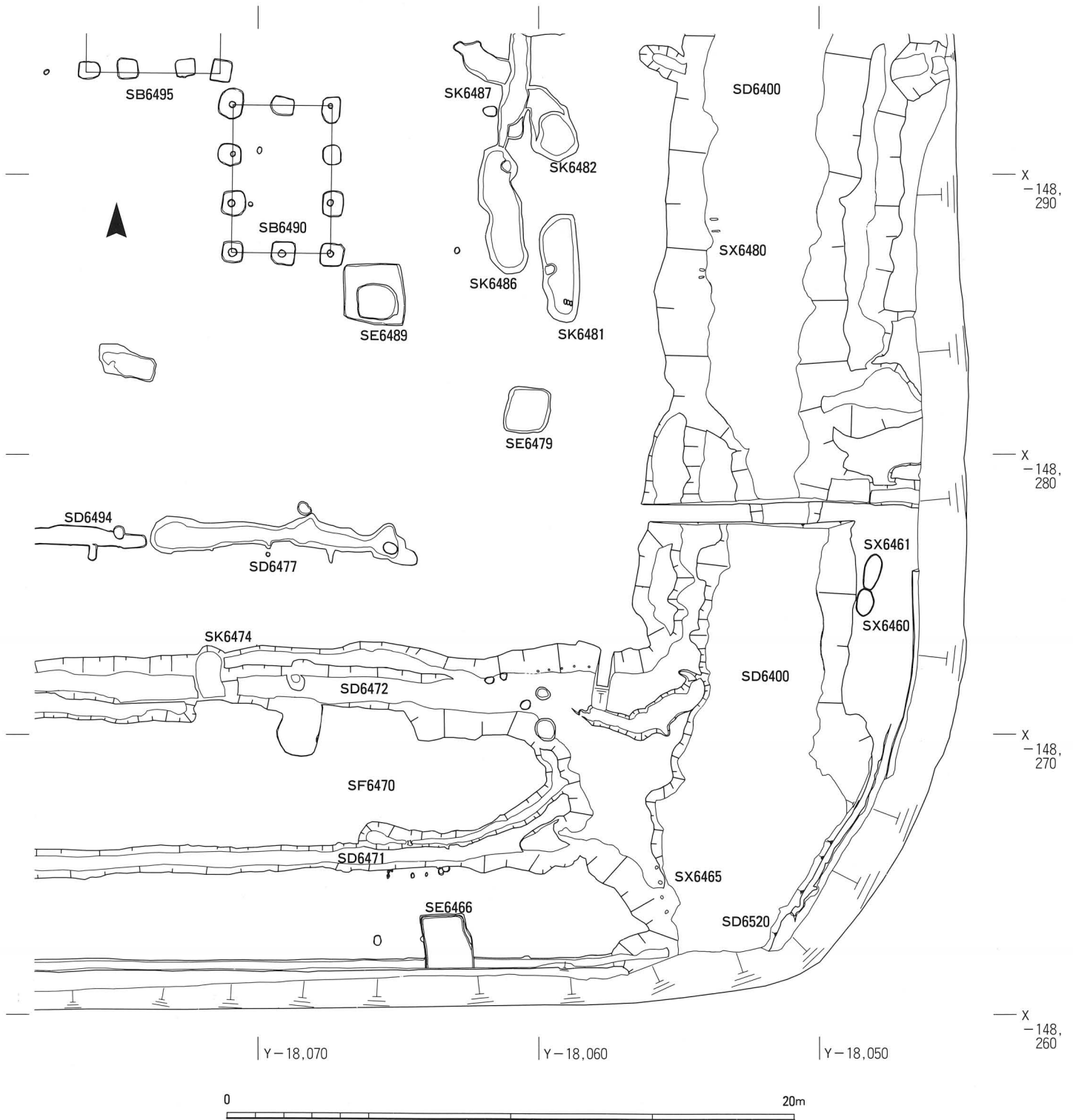

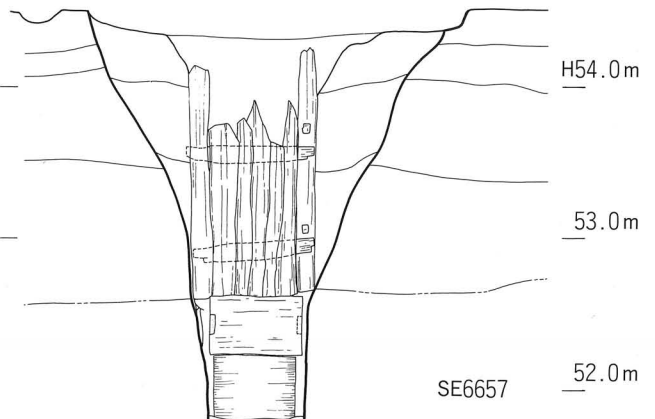
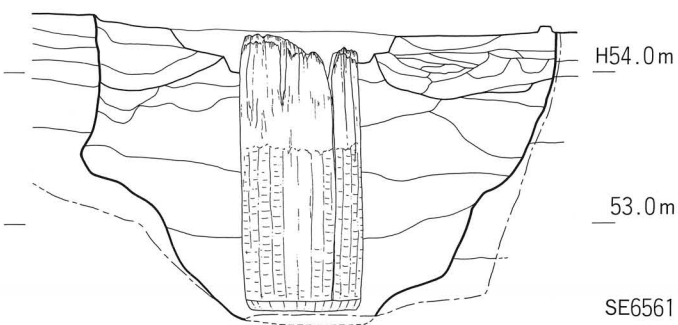
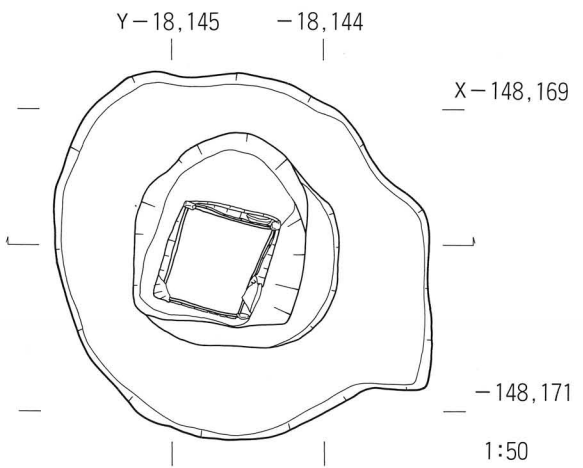
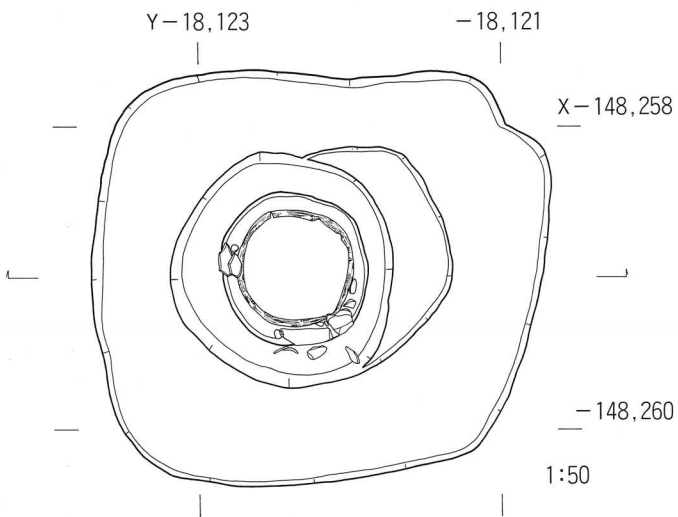
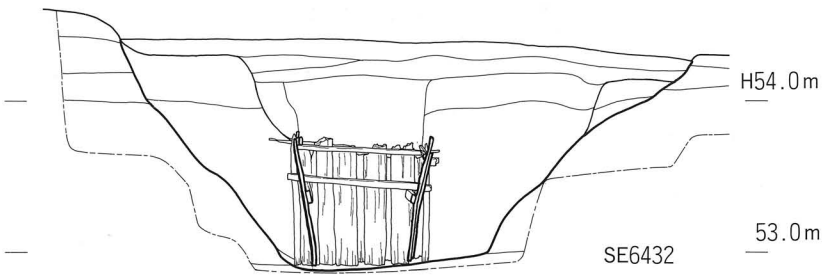
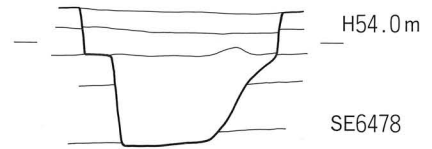
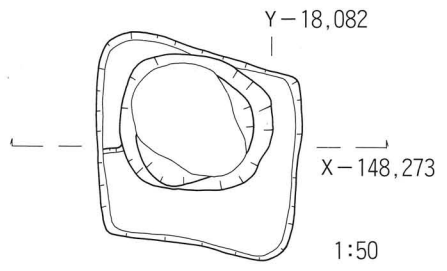
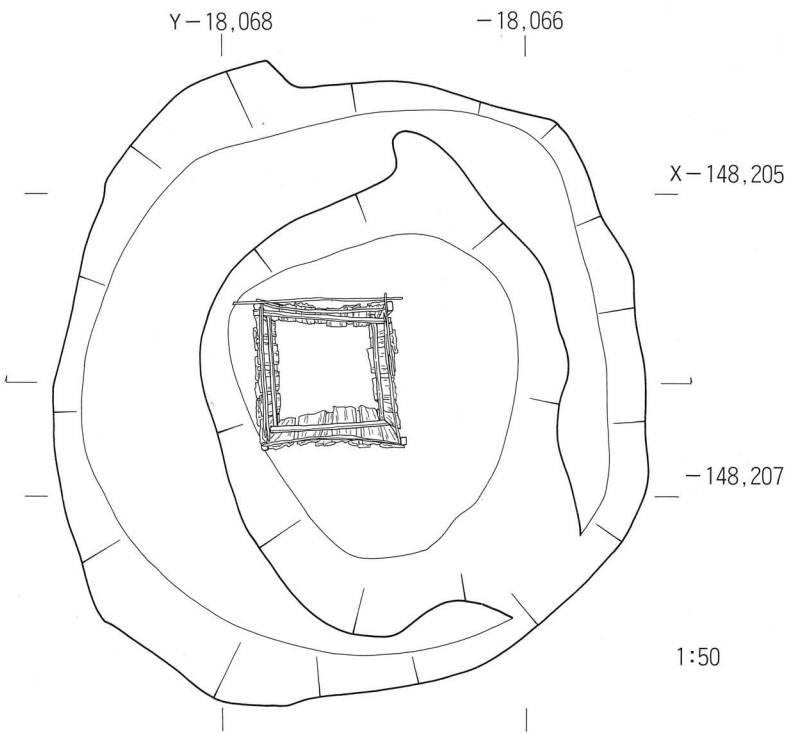

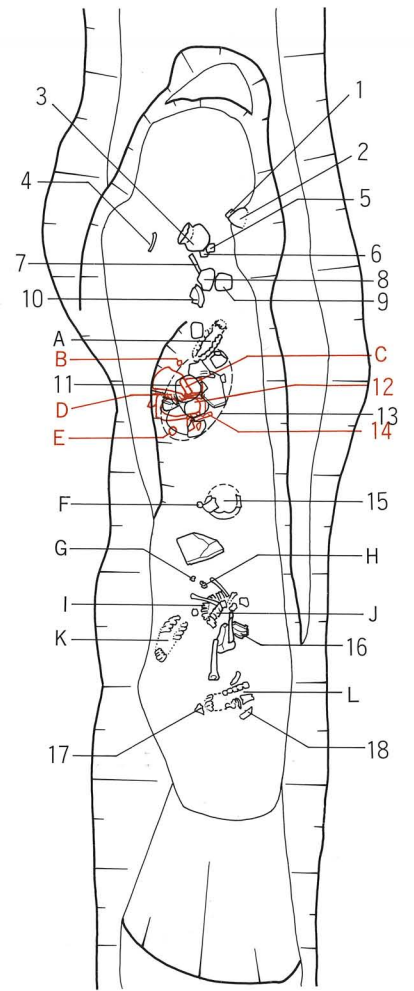
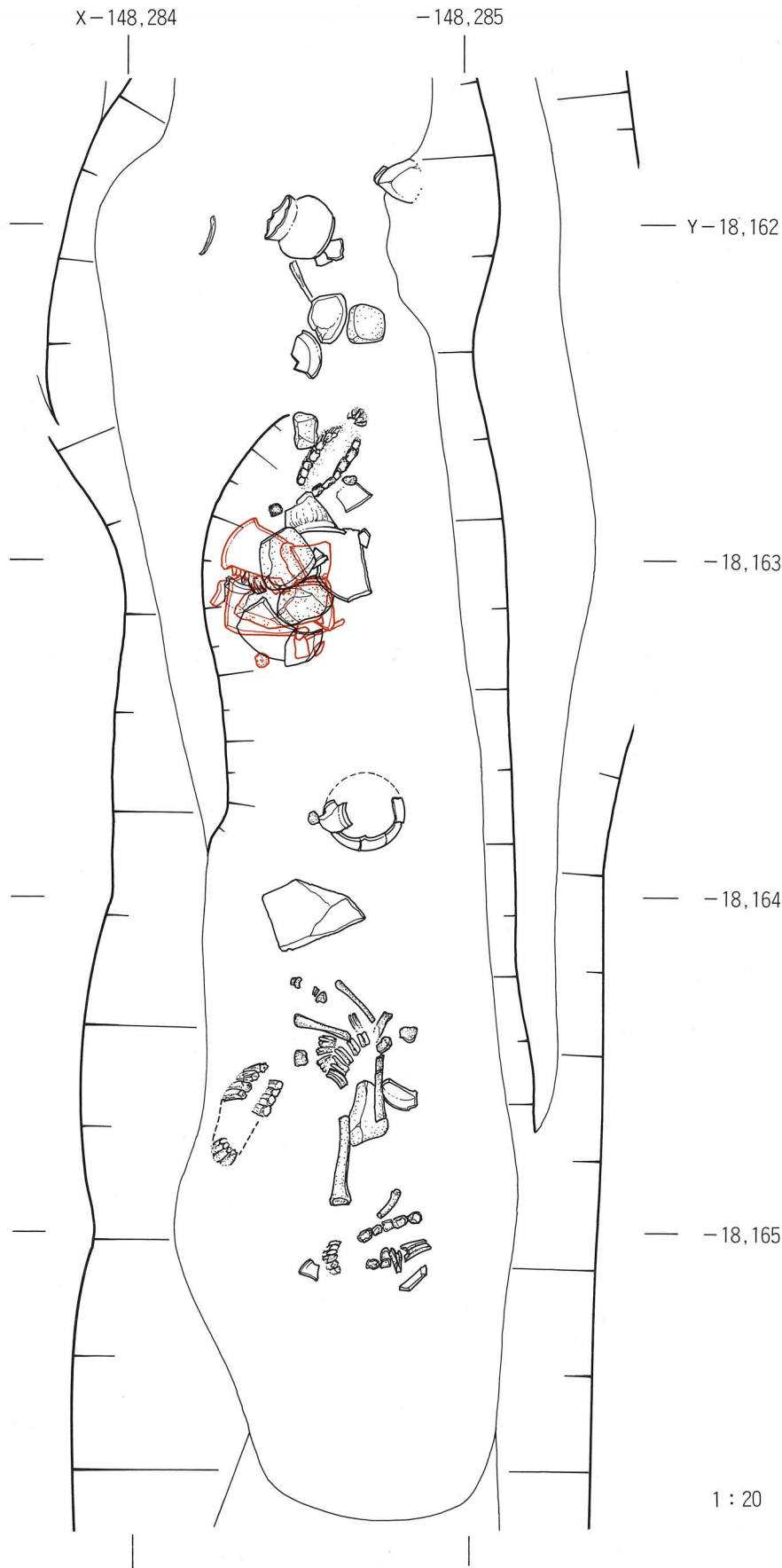

- |          |                     |
|----------|---------------------|
| A 下顎     | 1 須恵器杯 A            |
| B 骨      | 2 自然石               |
| C 骨      | 3 須恵器壺 Q            |
| D 齒集合    | 4 木(松明片)            |
| E 骨      | 5 須恵器甕              |
| F 上腕骨右遠位 | 6 須恵器甕              |
| G 指骨     | 7 木片                |
| H 顎      | 8 須恵器壺 X<br>(漆運搬具)  |
| I 左下顎    | 9 自然石               |
| J 右下顎    | 10 土師器杯 C           |
| K 上顎     | 11 自然石              |
| L 上顎     | 12 自然石              |
|          | 13 土師器甕 C<br>(墨書人面) |
|          | 14 管状木製品            |
|          | 15 土師器甕 A           |
|          | 16 土師器杯 B           |
|          | 17 土師器甕             |
|          | 18 須恵器杯 B           |

1:20



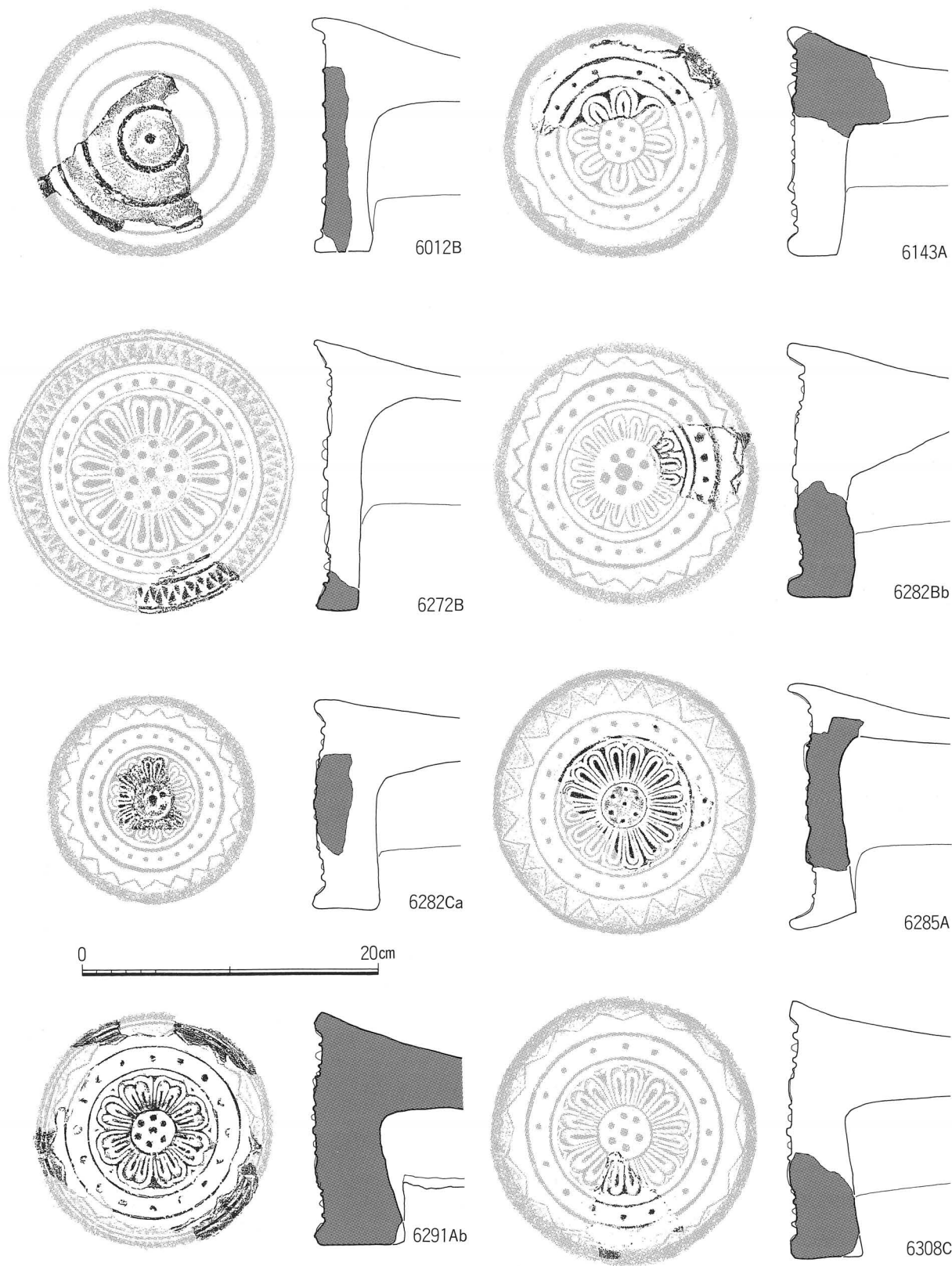

形式・種	直径	内 区						外 区		外 縁			全長	玉縁長
		中房径	圈線	蓮子数	弁区径	弁数	間弁	幅	文様	幅	高さ	文様		
		第一圈径	第二圈径	第三圈径	第四圈径									
6012B	160	42	90	127	139			11	8			傾斜縁 I		
6143A	155	33	あり	1+6	87	T8	B	12	S18	20	8	LV	傾斜縁 I	
6272B	185	54	なし	1+4+8	113	F8	A	11	S33	26	10	MV58	三角縁	
6282Bb	167	43	あり	1+6	90	F8	B	16	S24	23	10	LV24	傾斜縁 I	
6282Ca	138	28	あり	1+6	69	F8	B	17	S24	21	10	LV24	傾斜縁 III	
6285A	161	31	あり	1+6	89	F8	B	17	S23	19	15	LV22	傾斜縁 II	
6291Ab	154	29	あり	1+6	85	F8	B	14	S16	21	6	LV16	傾斜縁 III	
6308C	174	35	あり	1+6	96	F8	A	16	S16	23	7	LV	傾斜縁 I	

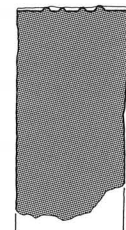
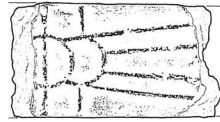
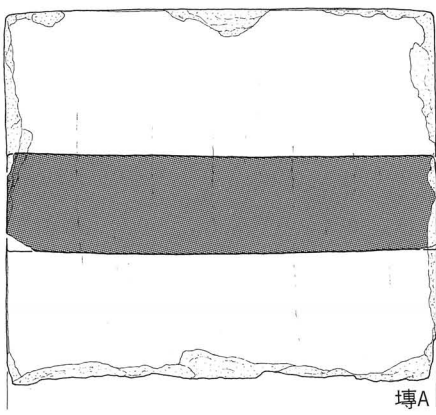
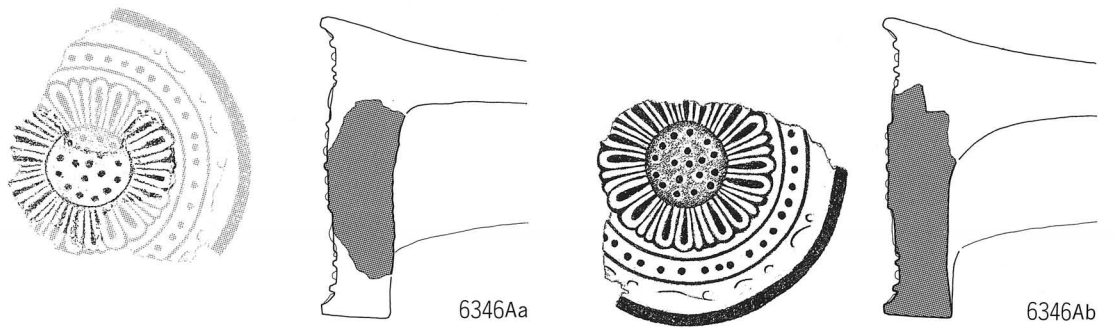
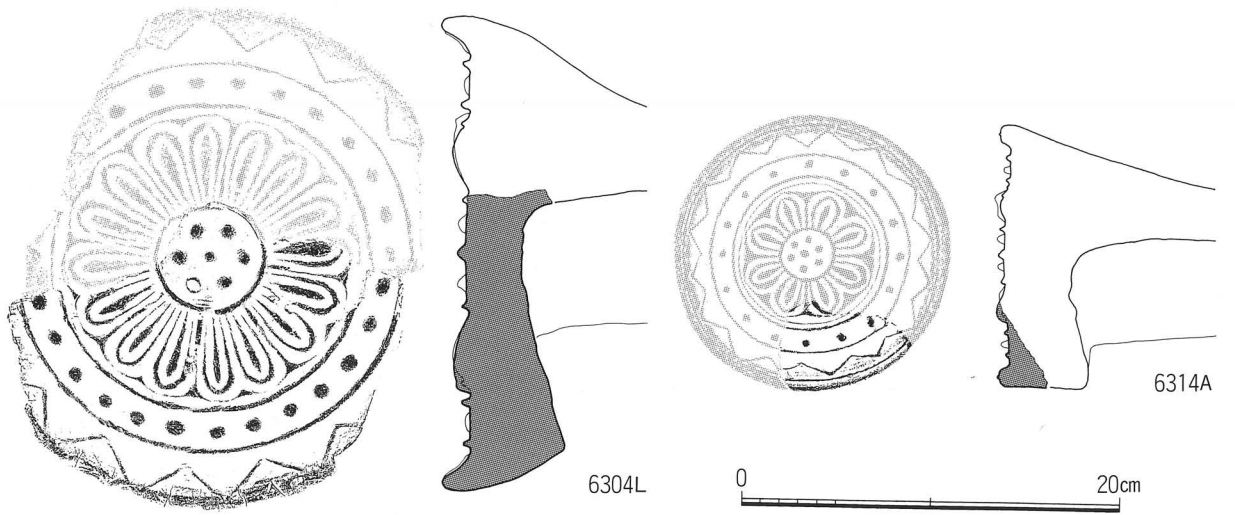

文様塼

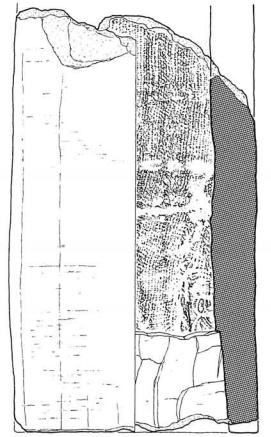

土管

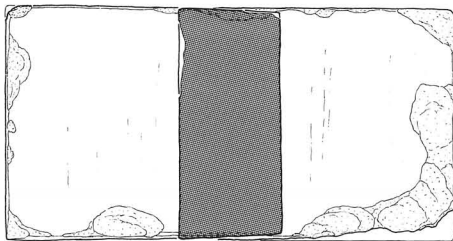

塼B

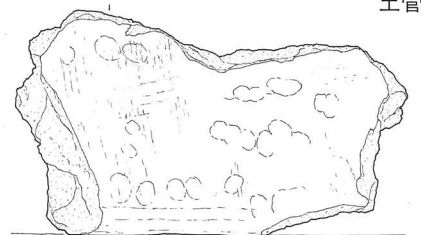
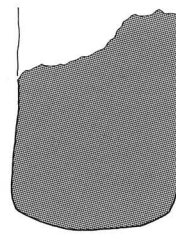

塼C

形式・種	直径	内 区						外 区		外 縁				全長	玉縁長
		中房径	圏線	蓮子数	弁区径	弁数	間弁	幅	文様	幅	高さ	文様	形態		
6304L	248	55	あり	1+6	163	F8	B	20	S27	20	15	LV17	傾斜縁Ⅲ	364	52
6314A	134	28	あり	1+6	78	F4	B	12	S16	12	5	LV16	直立縁		
6346Aa		44	あり	1+5+12		F8	A		S			唐草	傾斜縁Ⅰ		
6346Ab	157	43	あり	1+5+12	102	F8	A	13	S	13	7	唐草	傾斜縁Ⅰ		

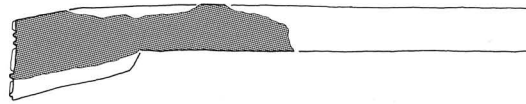
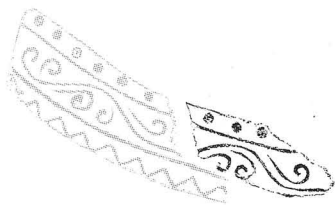

6641J



6663F

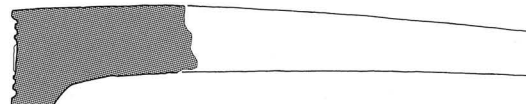
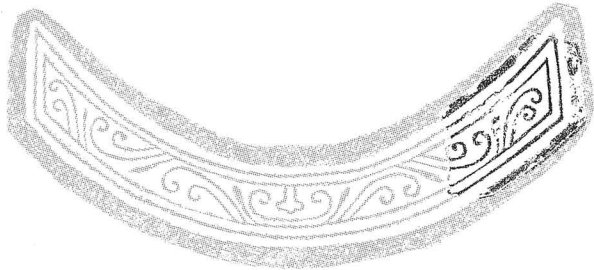

6663J



6668C



6681A

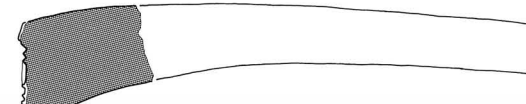
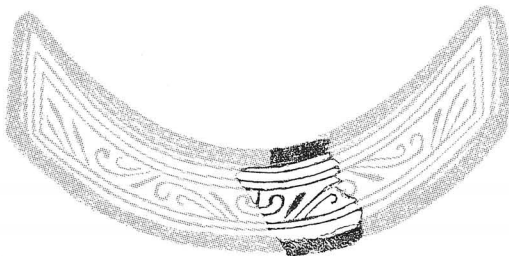

6681C

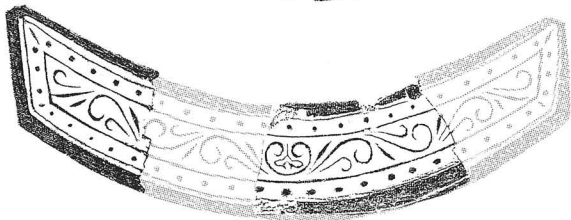

6691A



形式・種	最大幅	厚さ	内 区		上外区		下外区		脇 区		顎形態	全 長
			厚	文 様	厚	文 様	厚	文 様	厚	文 様		
6641J		43	21	HK	10	S	11	LV	-	-	段	
6663F	280	40	23	KK	8	K	10	K	8	K	曲II	
6663J		40	23	KK	9	K	12	K	10	K	曲II	
6668C		37	23	KK	8	S	8	S	10	S	段	
6681A	232	28	16	KK	5	K	5	K	7	K	曲 I	
6681C	240	31	17	KK	6	K	6	K	10	K	曲 I	
6691A	265	39	23	KK	7	S21	8	S21	7	S3	曲II	344



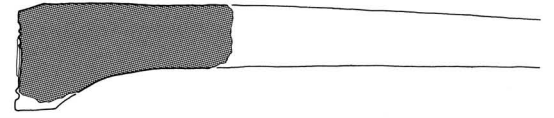
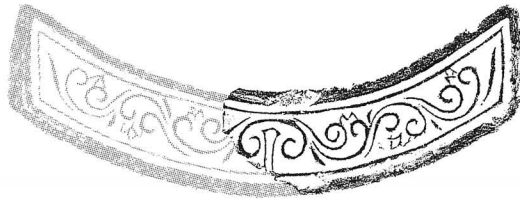

6703A

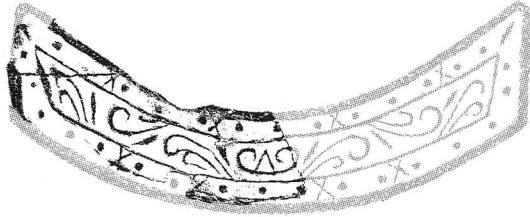

6710A

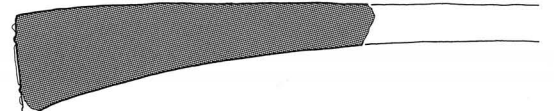

6710C

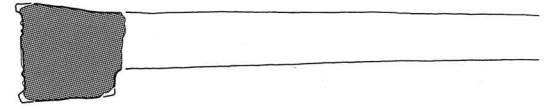
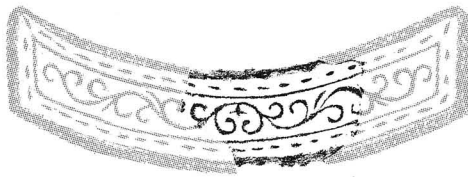

6716C

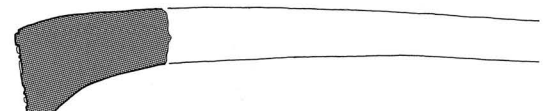

6721A



6721C

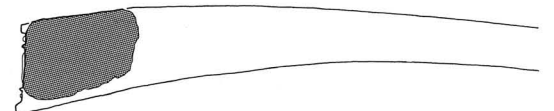
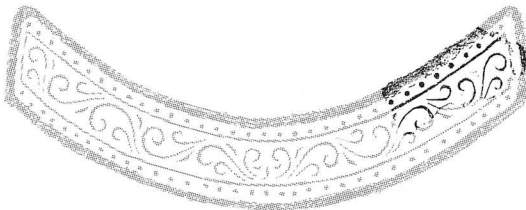

6721Gb



形式・種	最大幅	厚さ	内 区		上 外 区		下 外 区		脇 区		顎形態	全 長
			厚	文 様	厚	文 様	厚	文 様	厚	文 様		
6703A	270	51	31	KK	9	-	12	-	2	-	曲II	344
6710A	263	41	22	KK	8	S13 X4	10	S11 X4	13	S2	直	
6710C	270	43	25	KK	9	S13	9	S11	10	S3	直	355
6716C	228	44	41	KK	8	GS18	8	GS19	8	GS4	直	
6721A	256	33	20	KK	6	S26	6	S27	3		曲II	358
6721C	257	33	22	KK	6	S26	6	S32	4		曲II	
6721Gb	263	35	23	KK	5	S34	6	S35	3		直	350

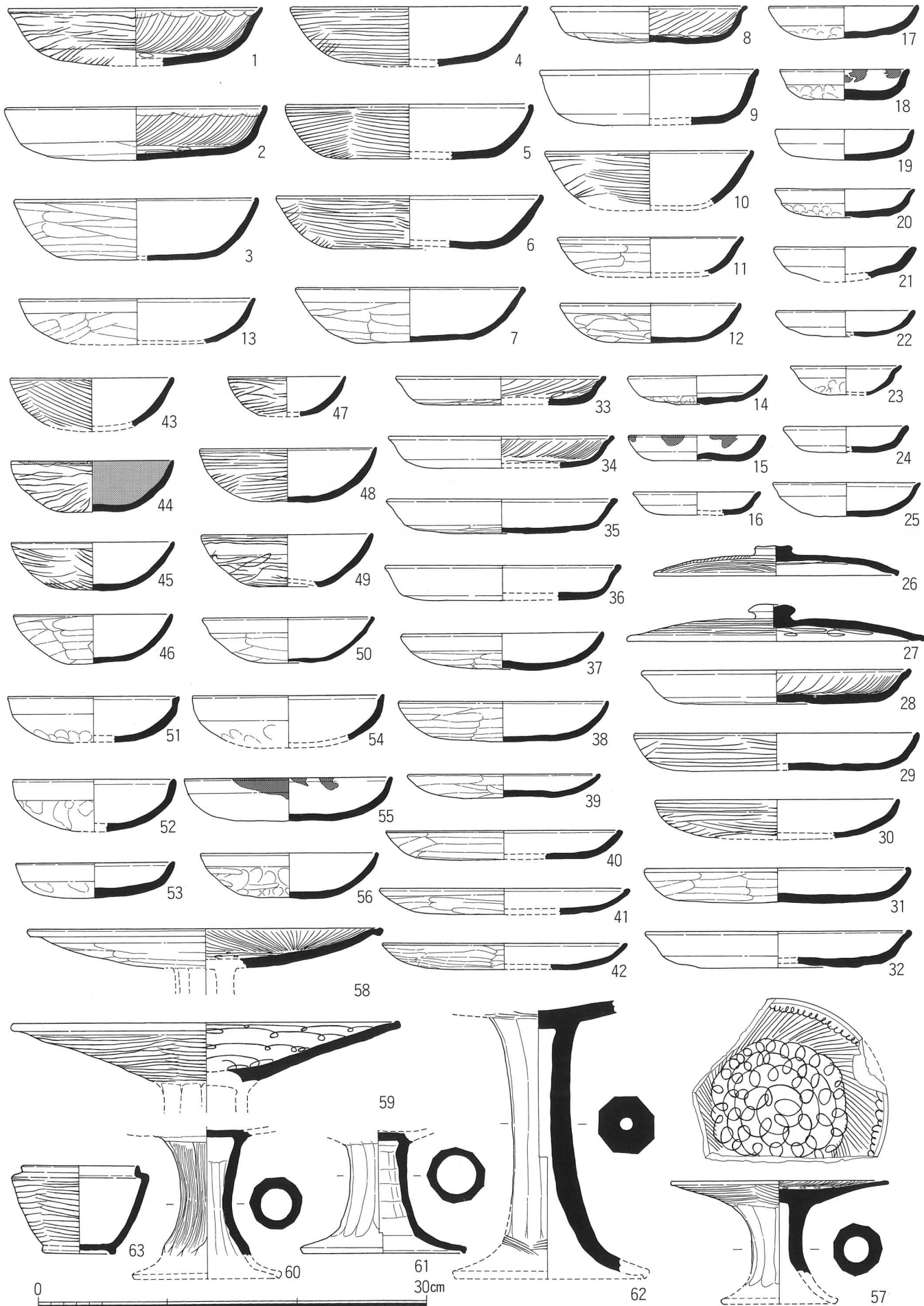

15・18・55は煤附着 44は漆附着 1:4

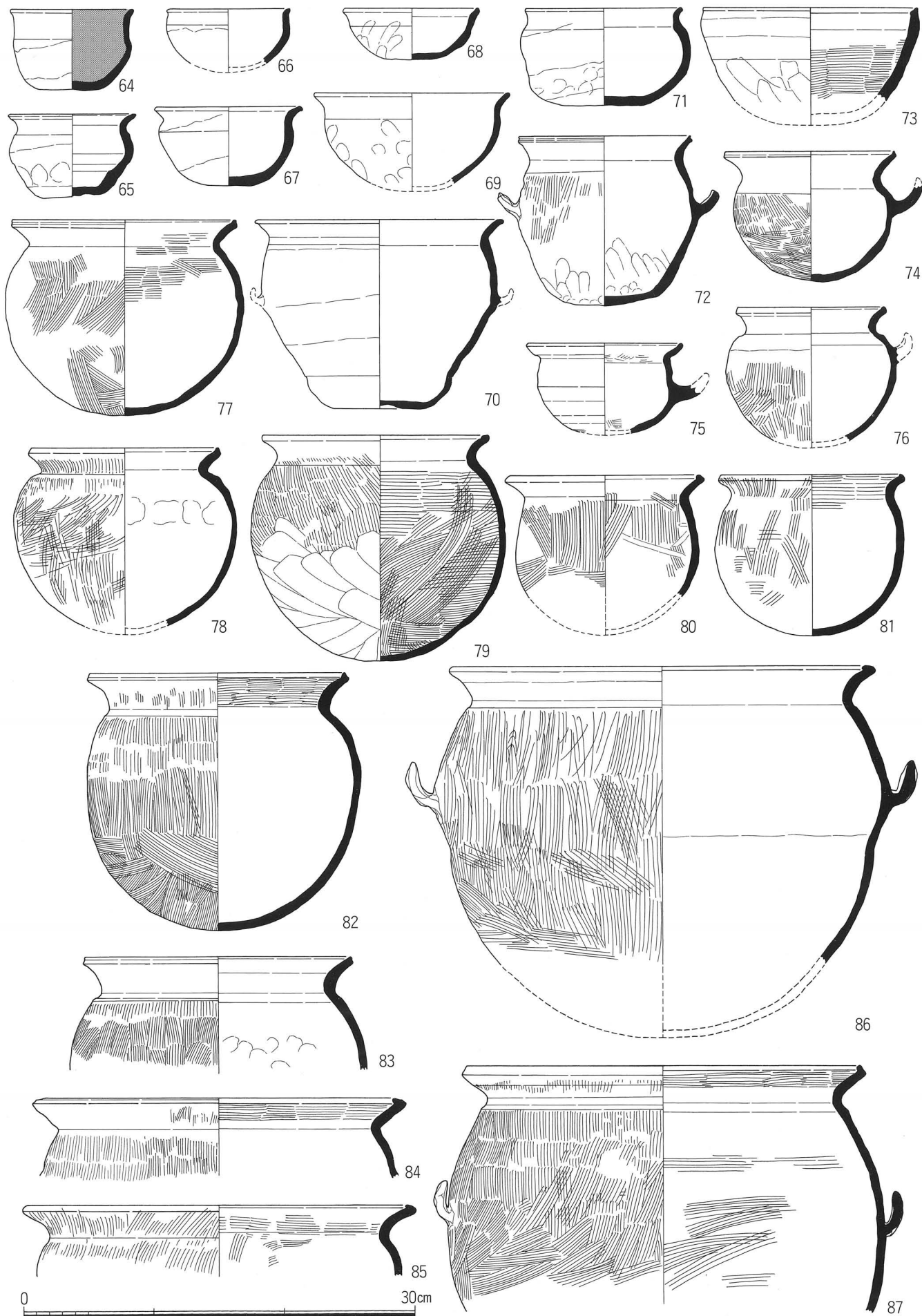



255は煤附着 1 : 4

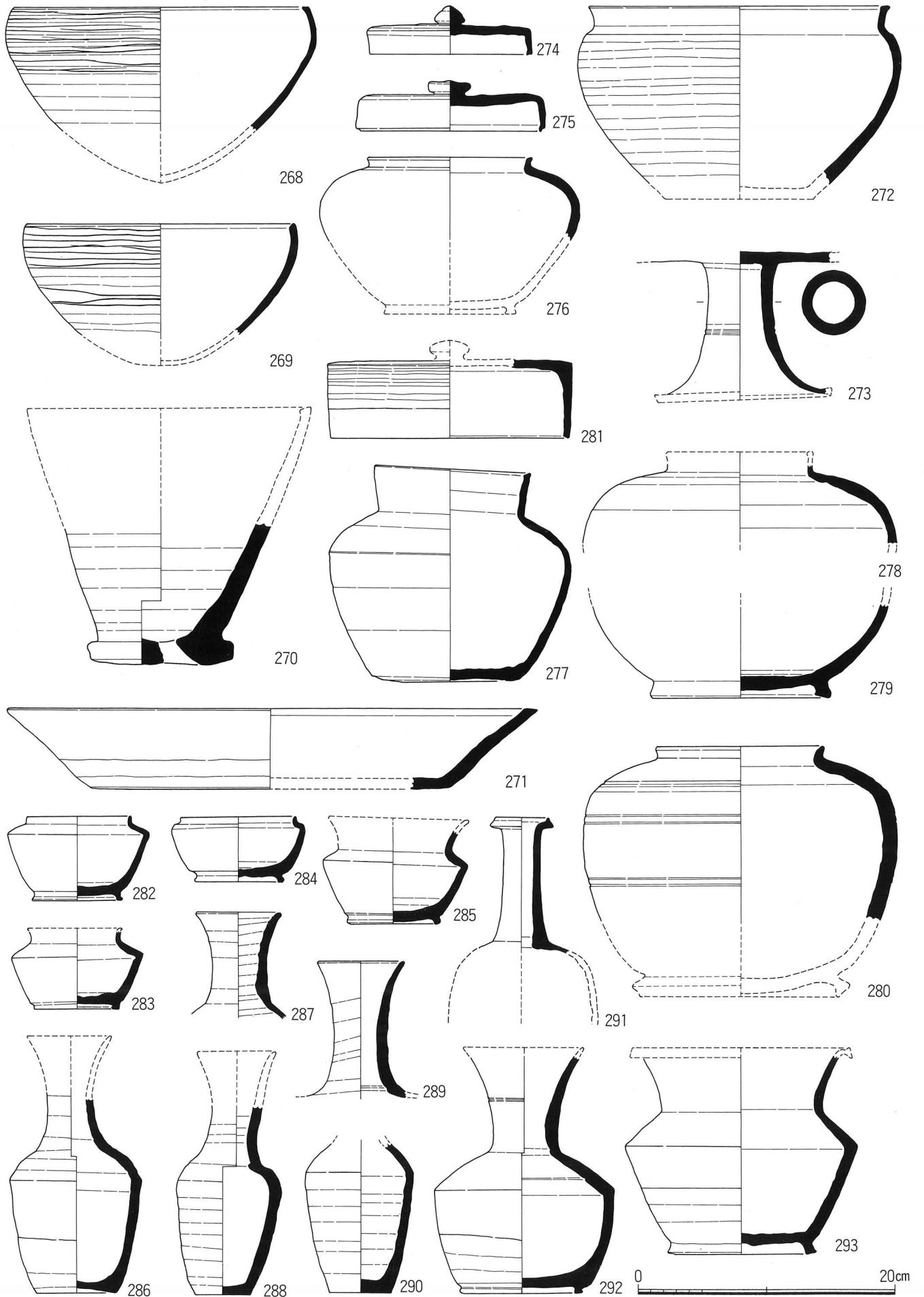

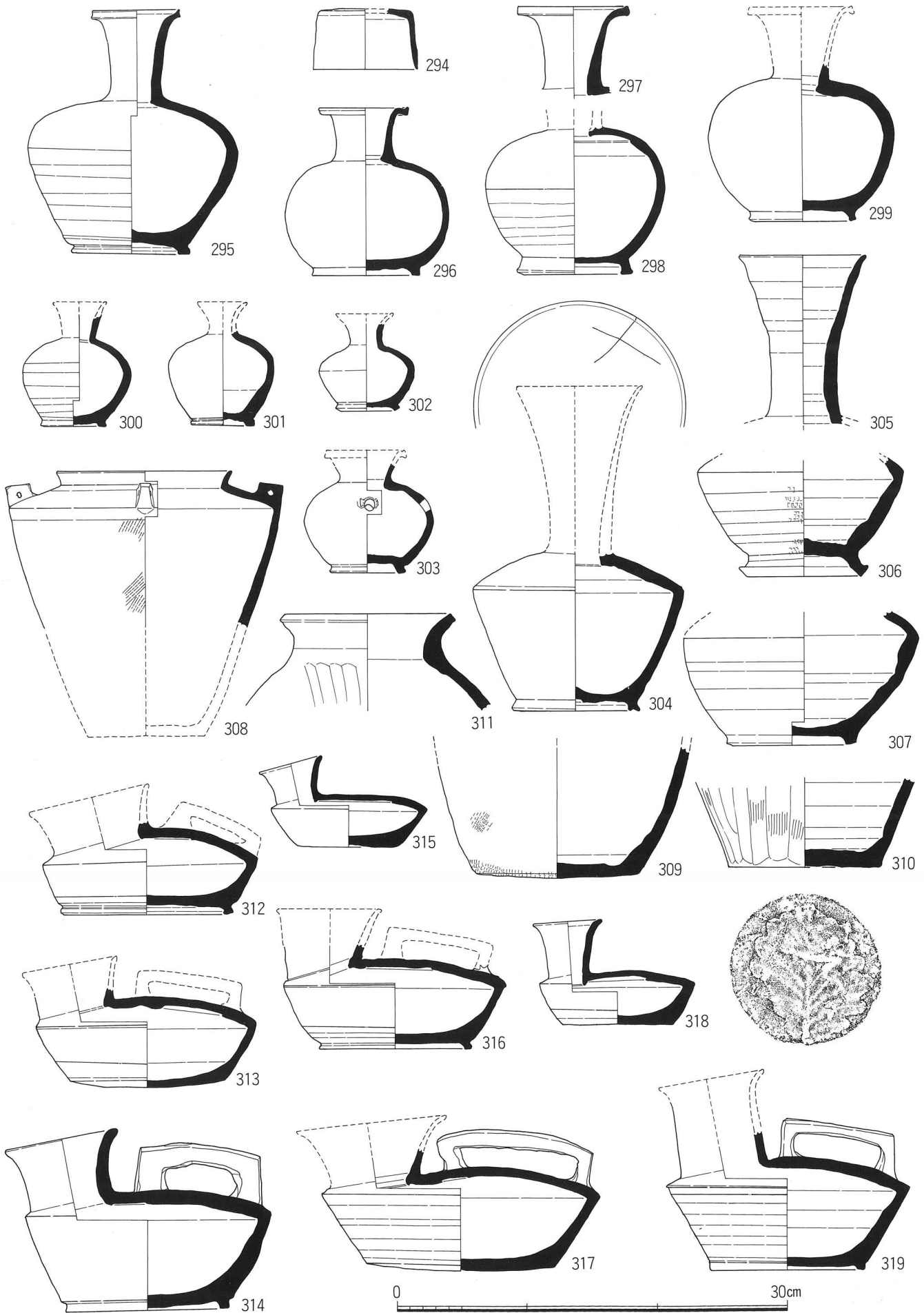

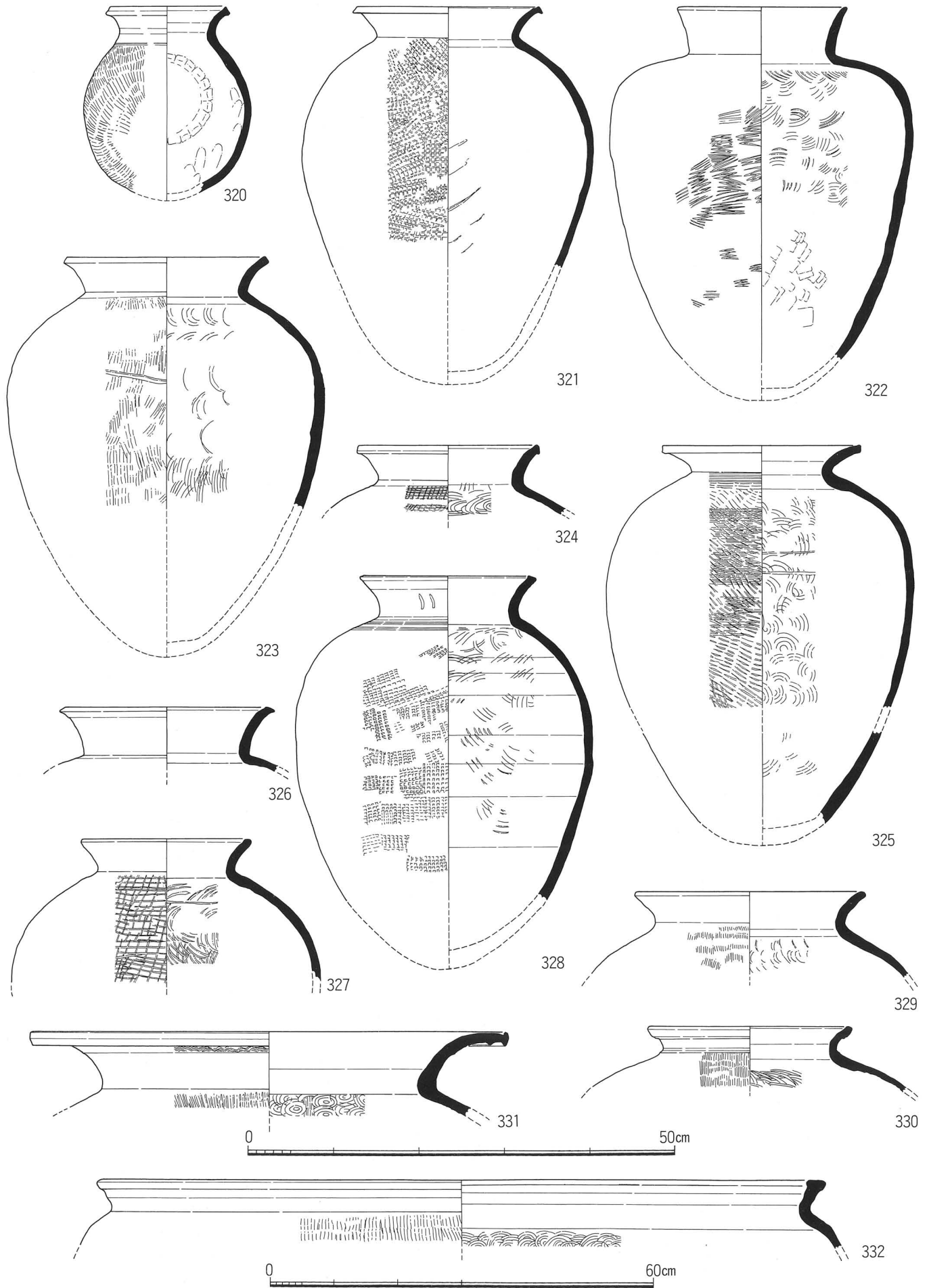

322 1:8 その他 1:6

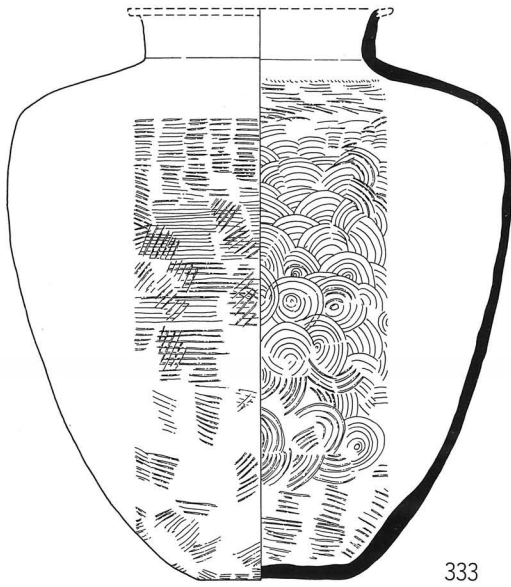

333

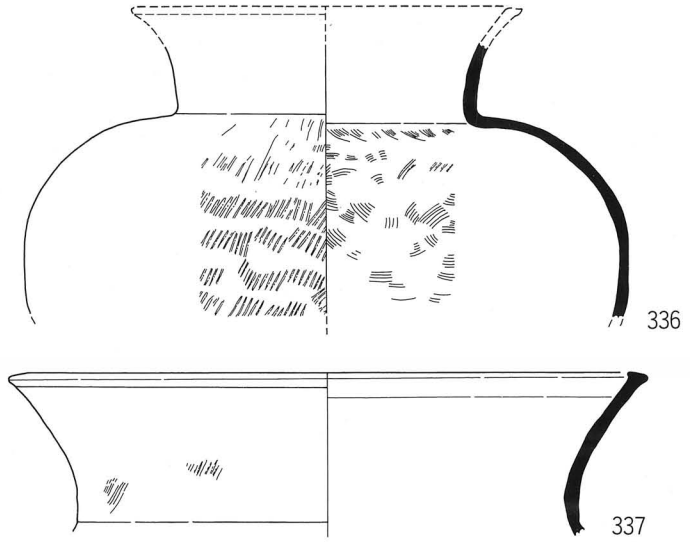

336

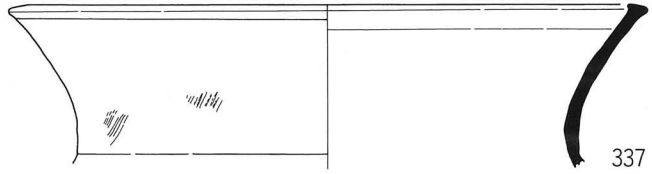

337

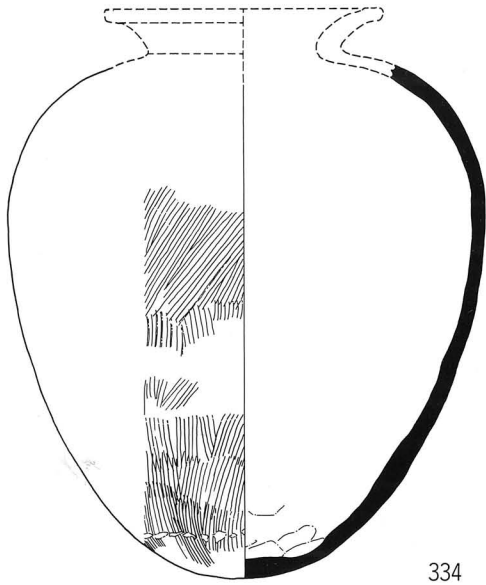

334

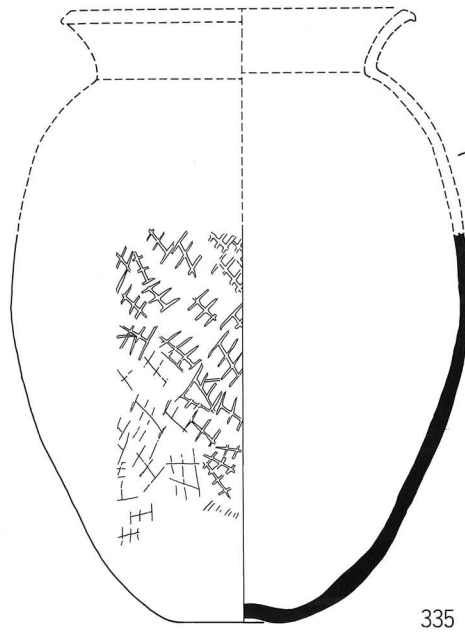

335

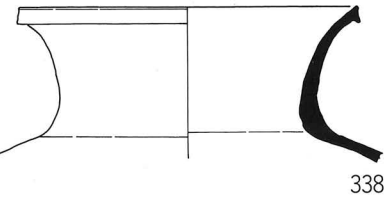

338

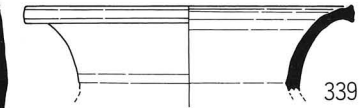

339

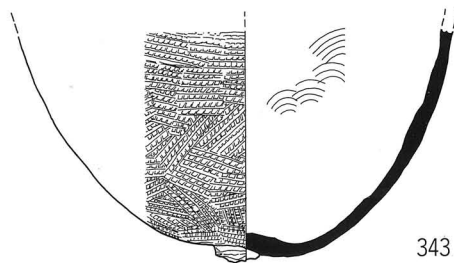

343

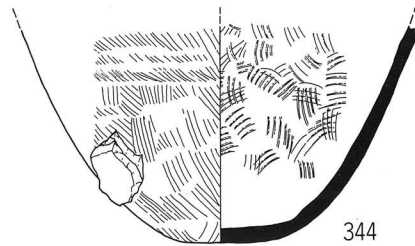

344

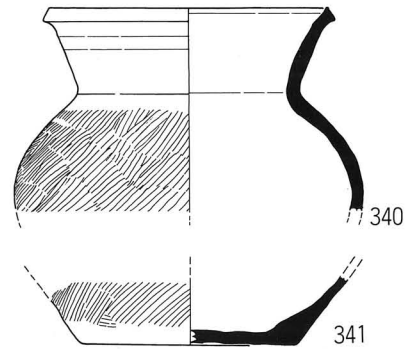

341

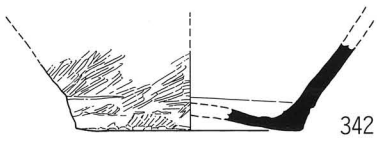

342

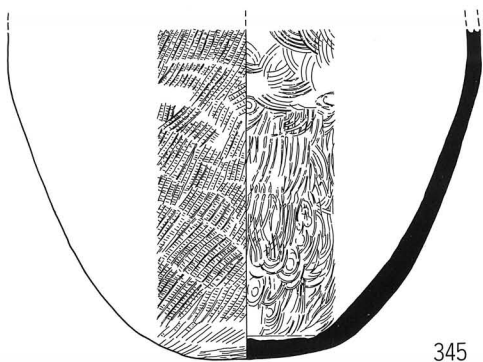

345

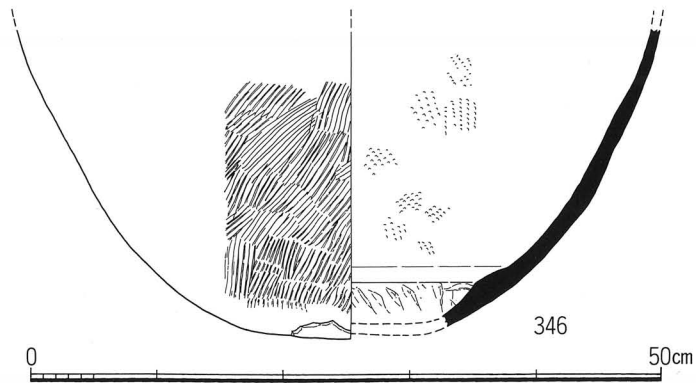

346

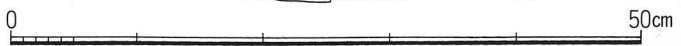



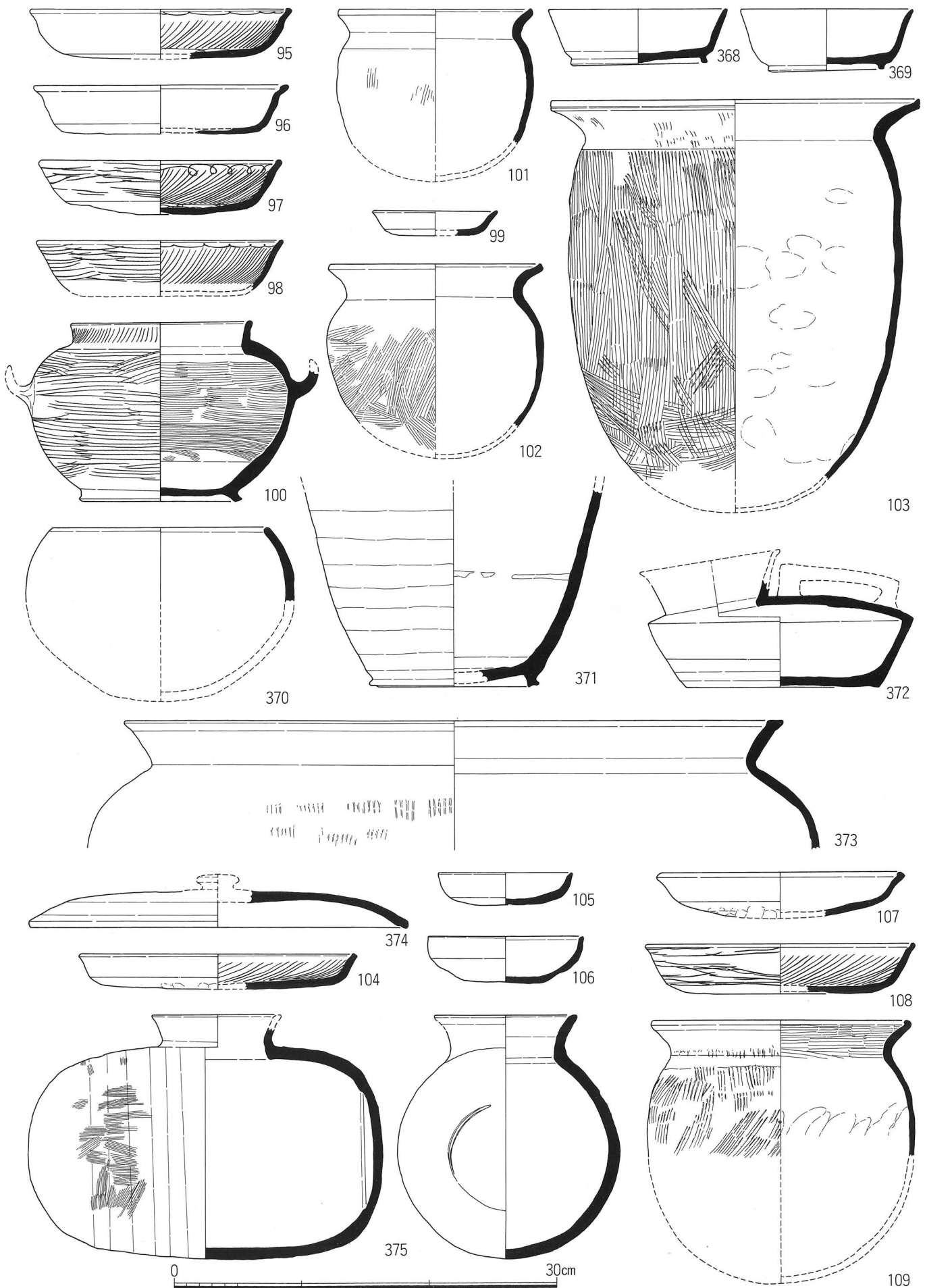

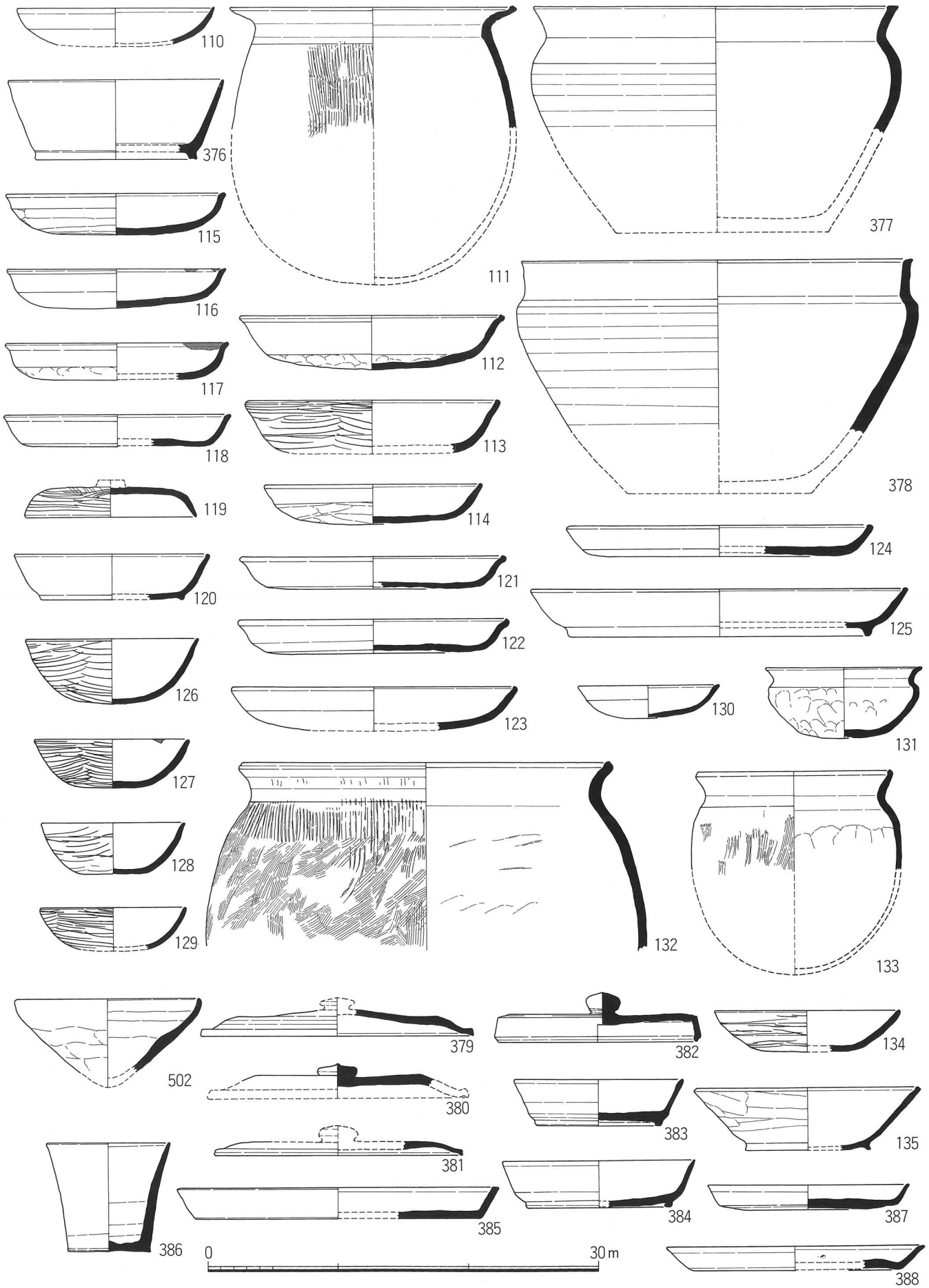

116・117・127は煤付着 1:4

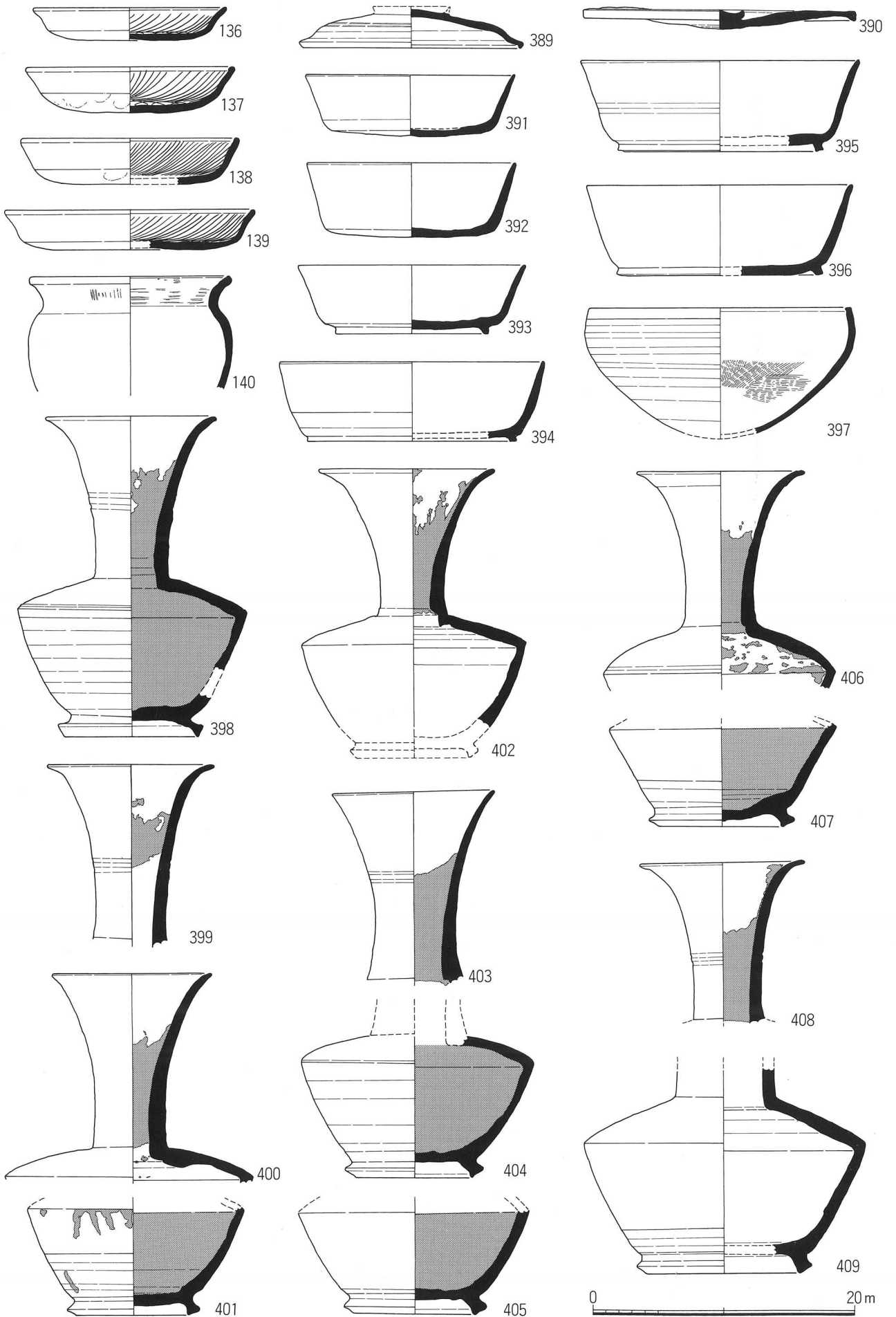

398~408は漆付着 1:4

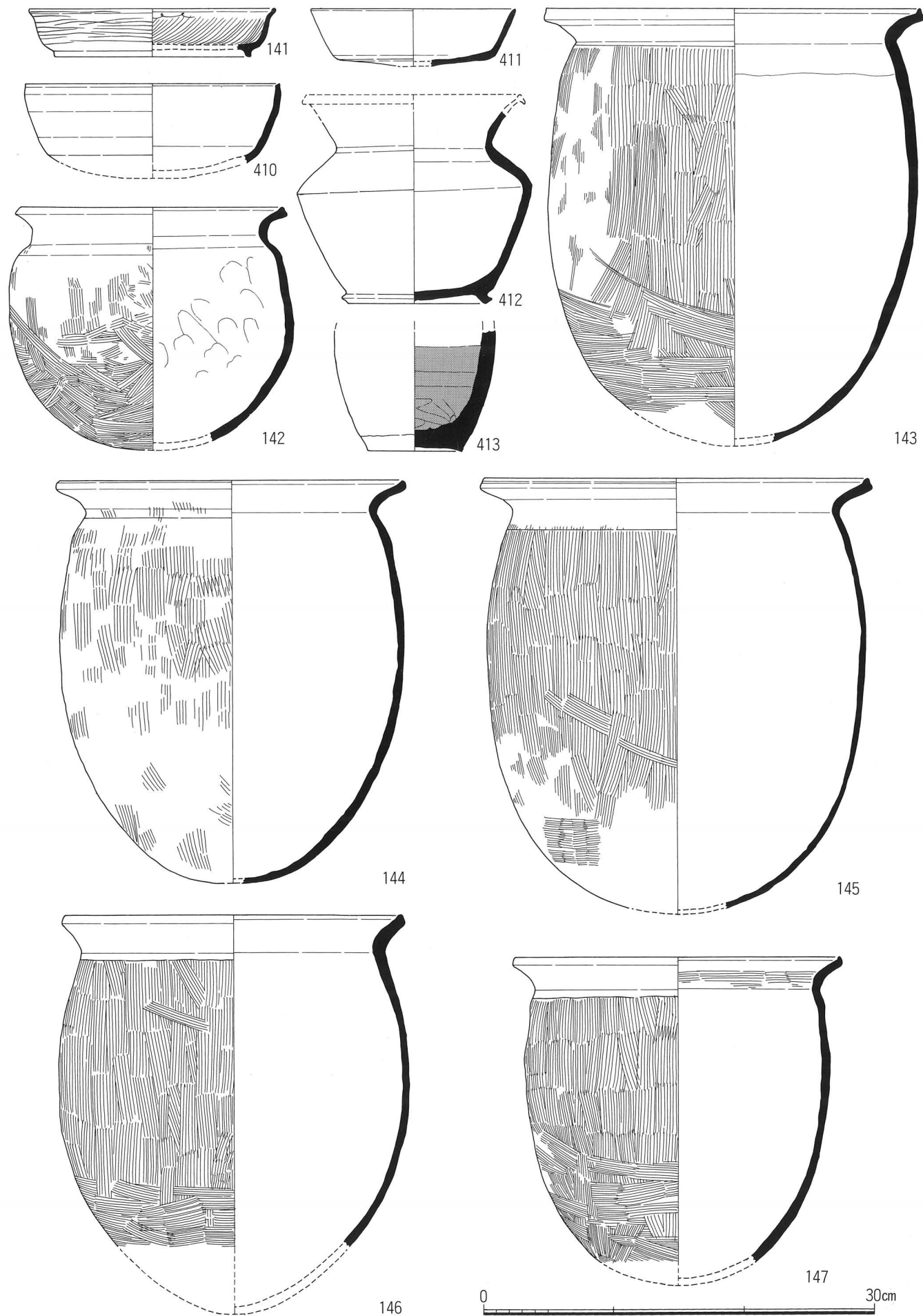

413は漆付着 1:4

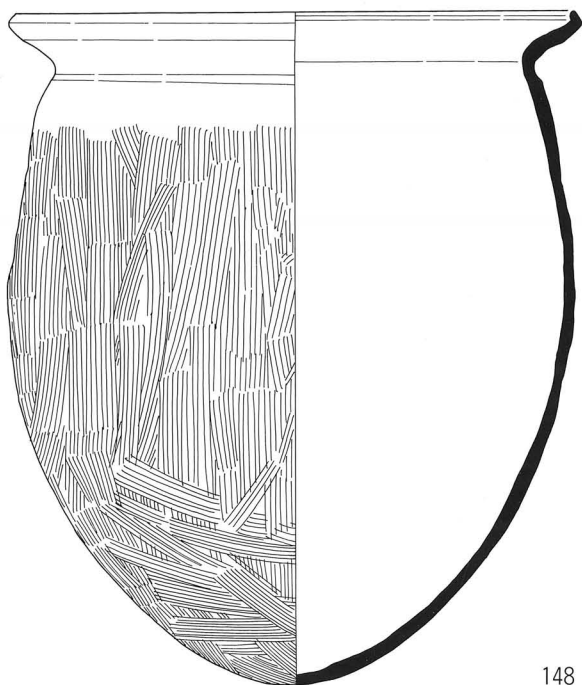

148

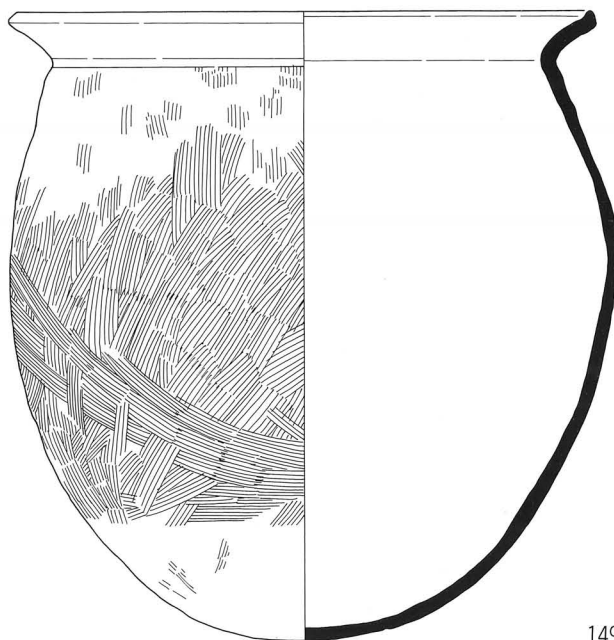

149

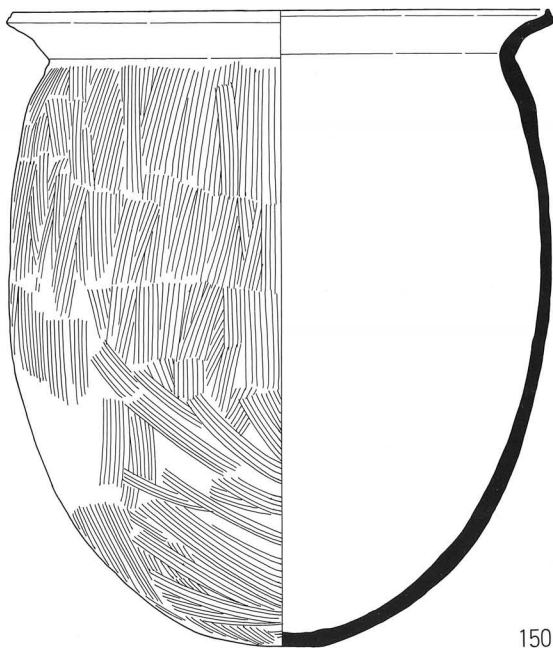

150

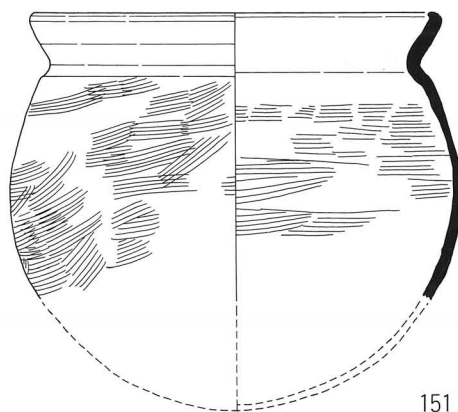

151

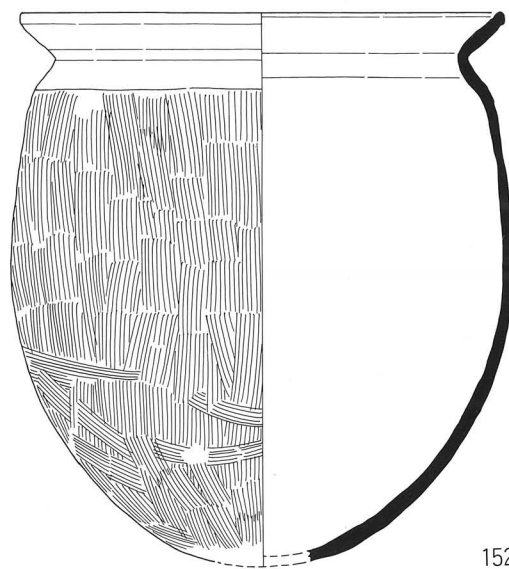

152

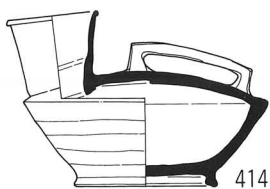

414

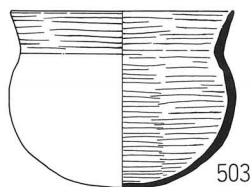

503

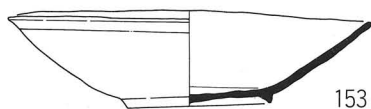

153



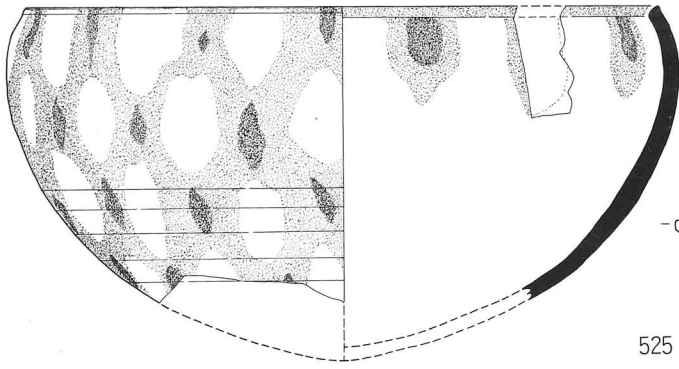

525

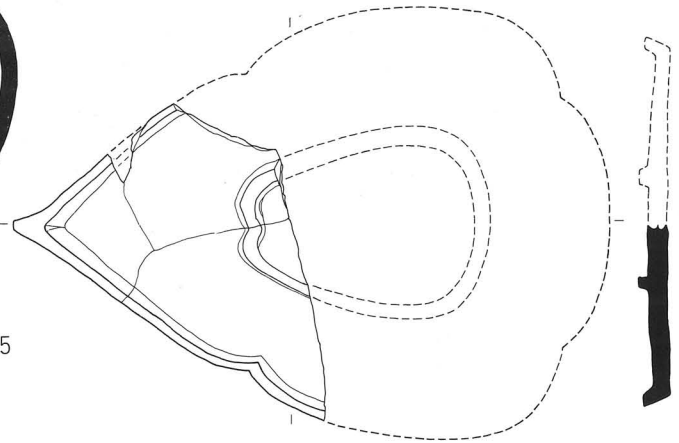

526

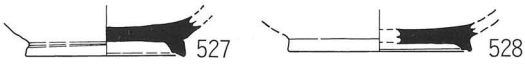

527



528

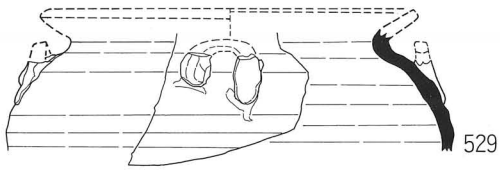

529

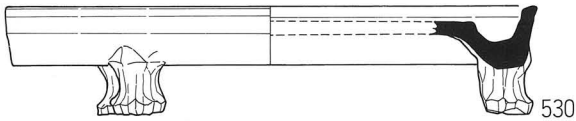

530

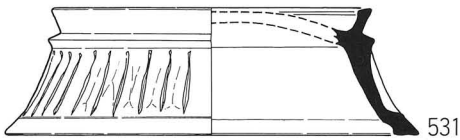

531

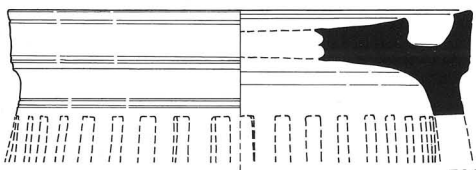

532

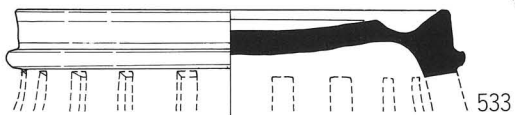

533

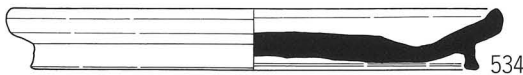

534



537

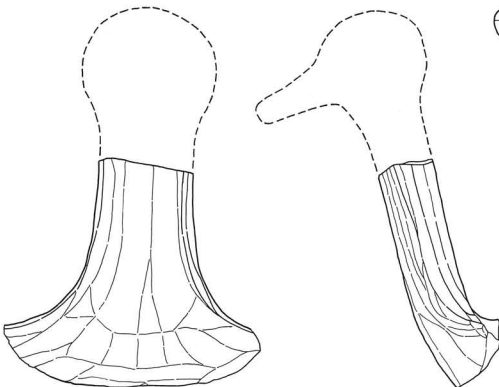

536

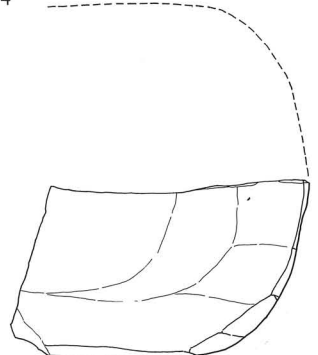
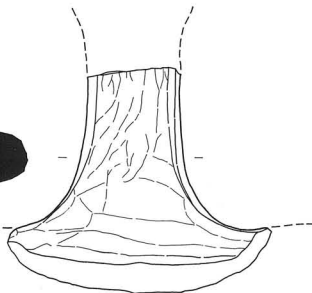

1:3

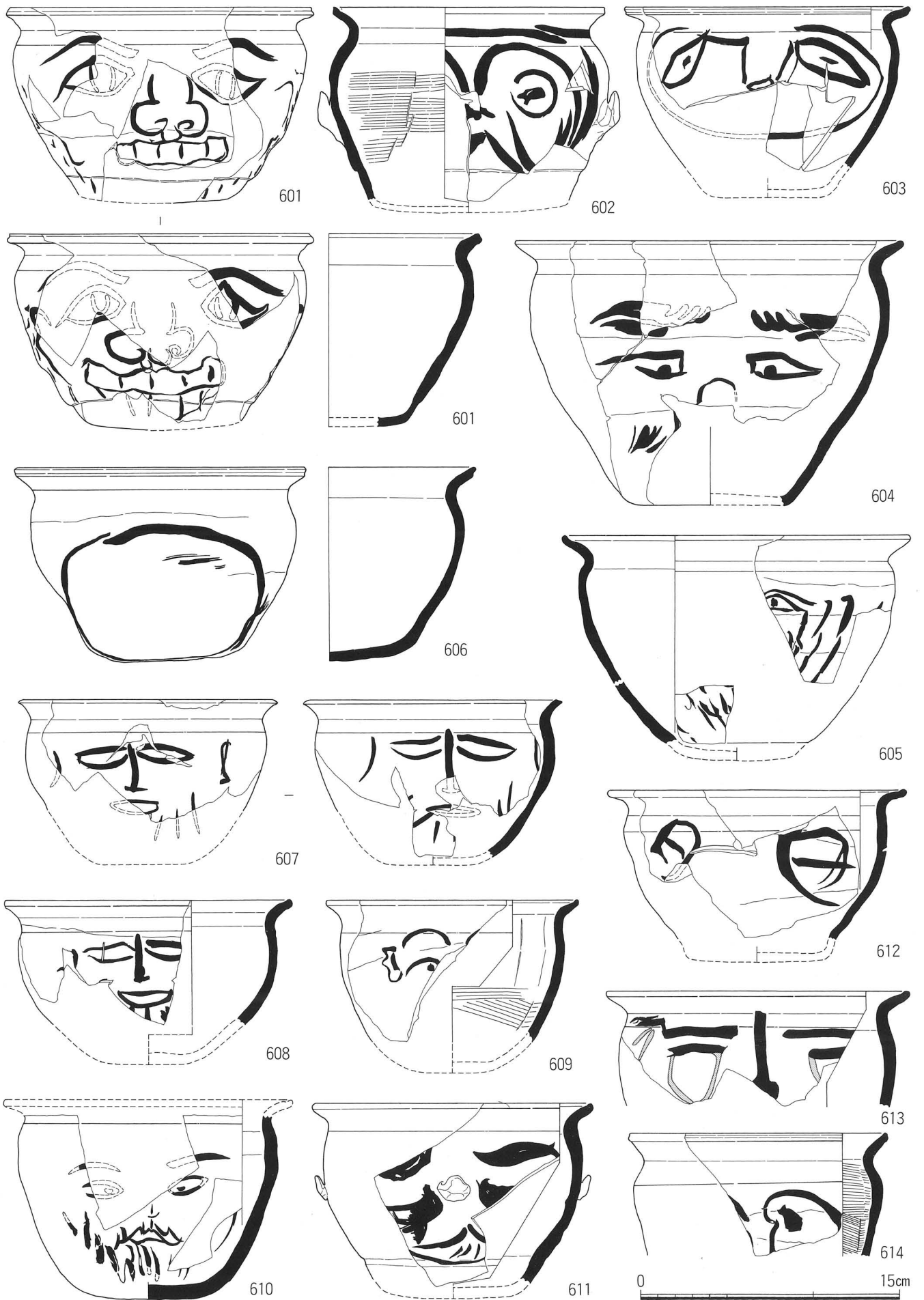

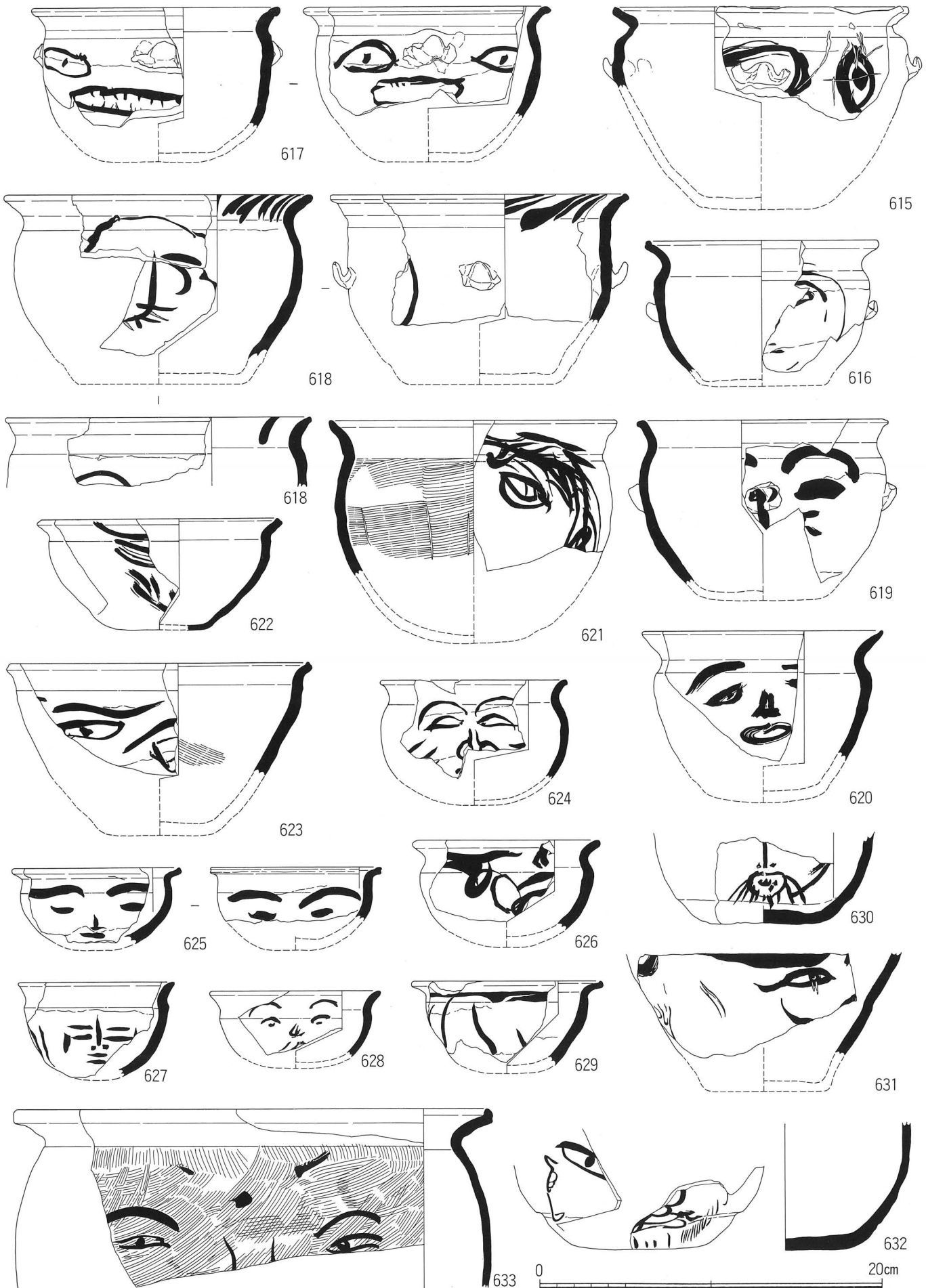



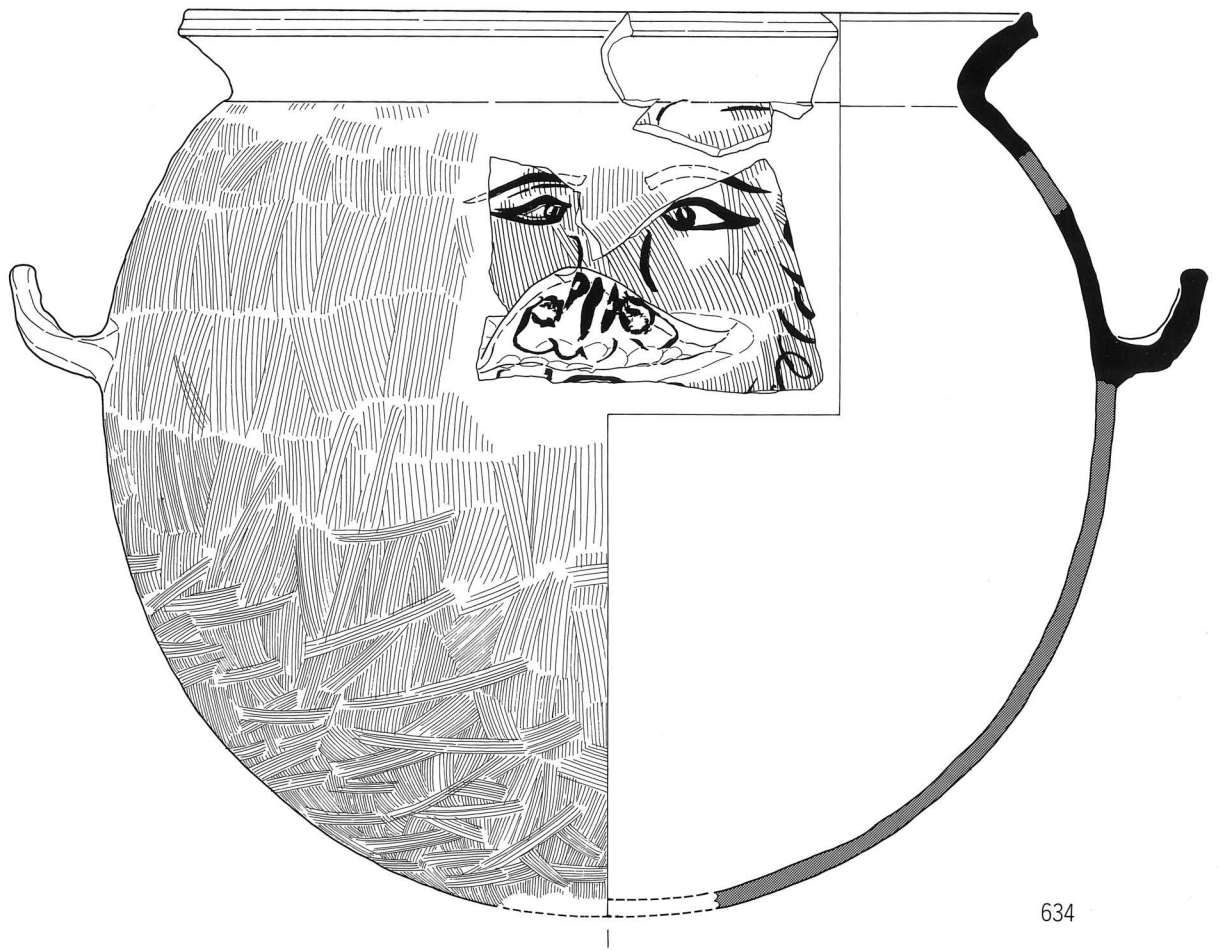

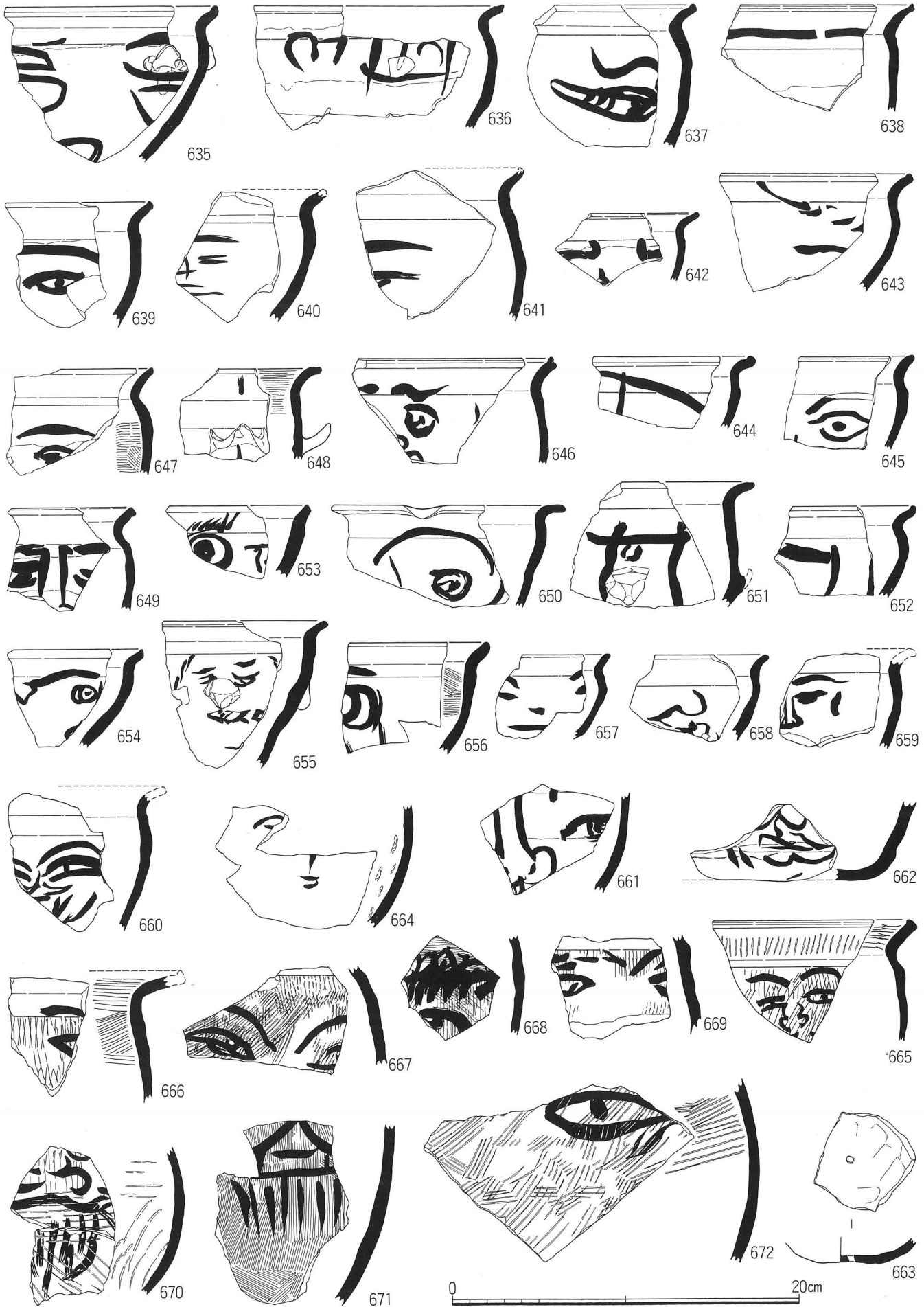

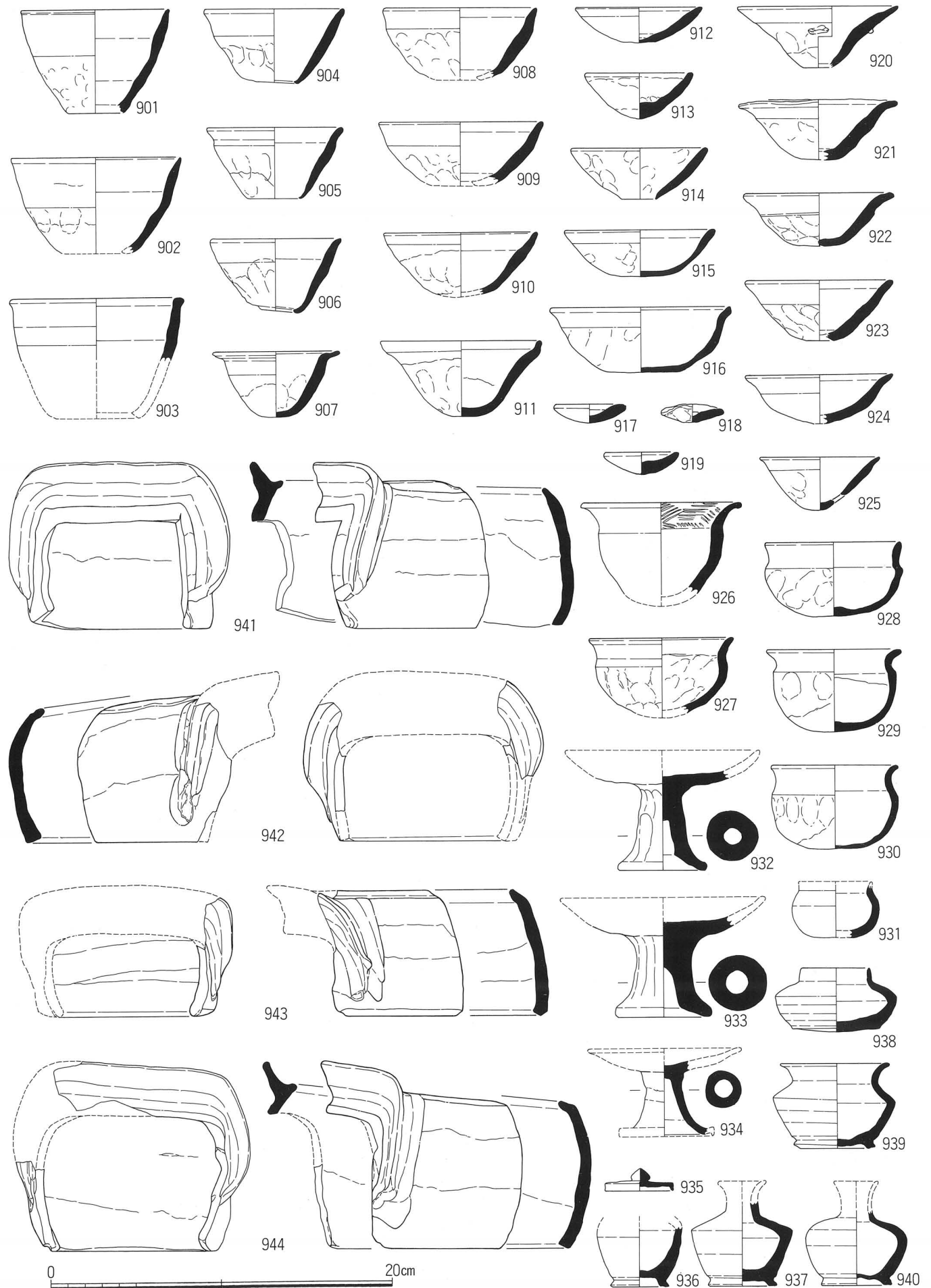

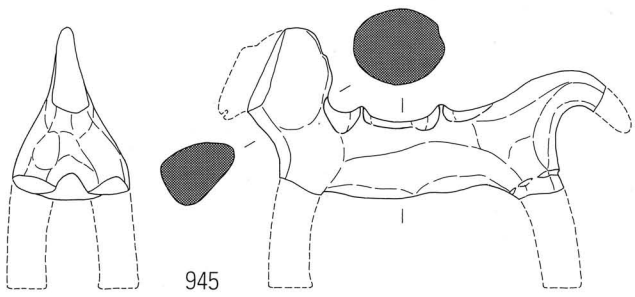

945

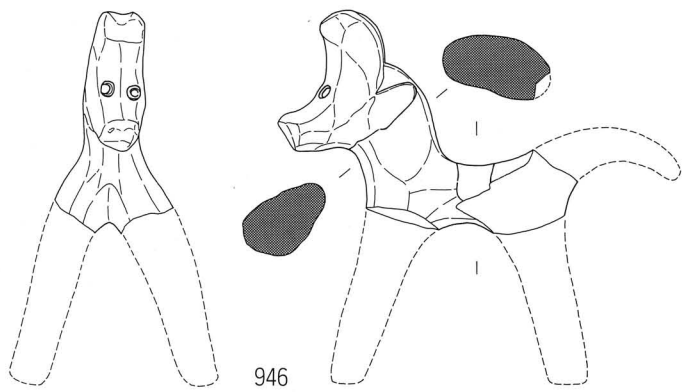

946

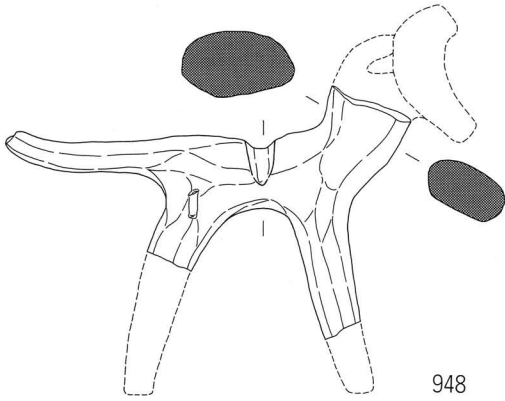

948

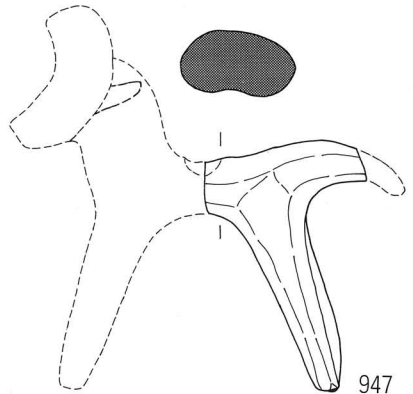
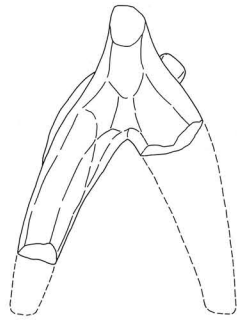

947

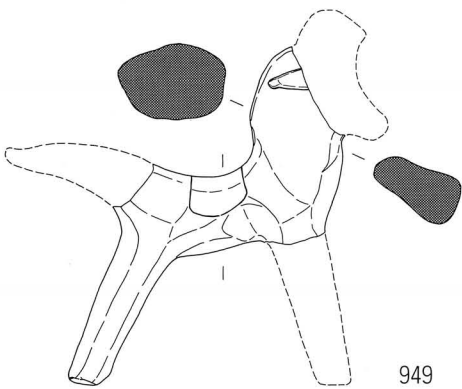

949

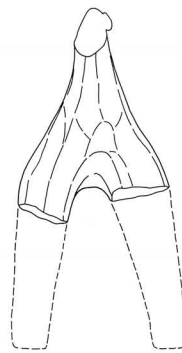
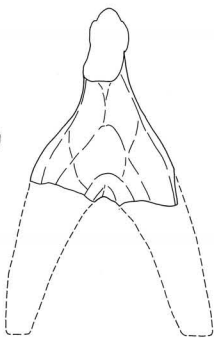

950

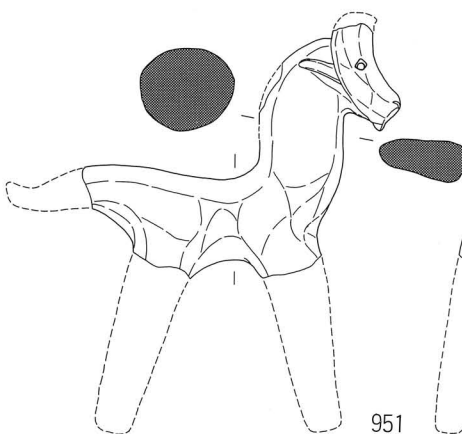
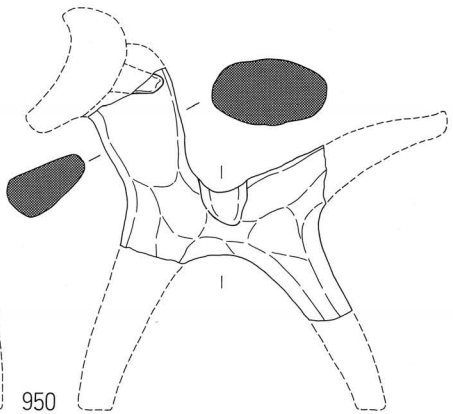

951

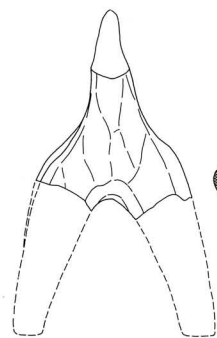
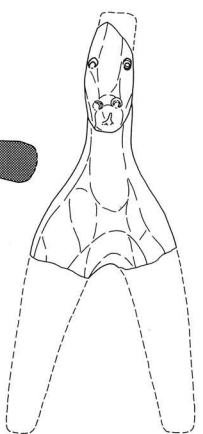

952

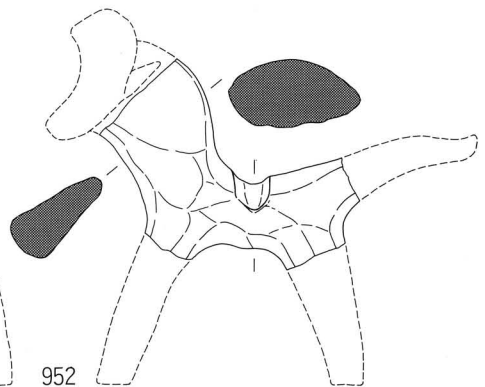

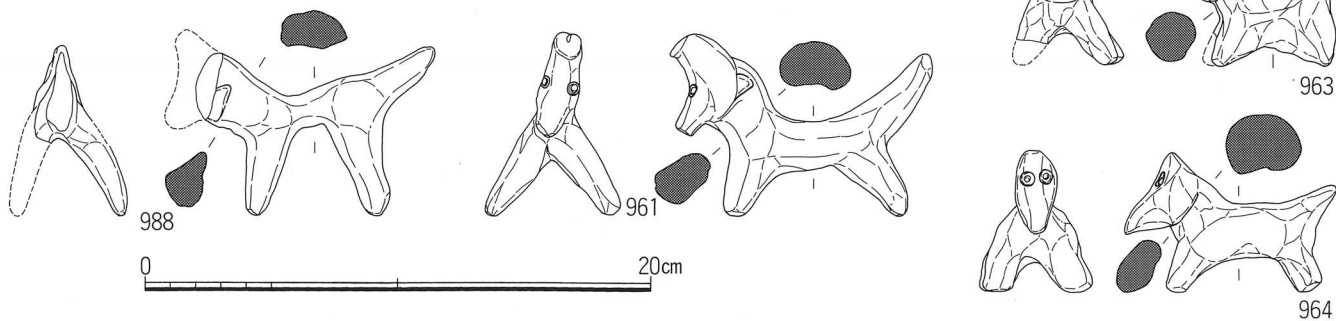
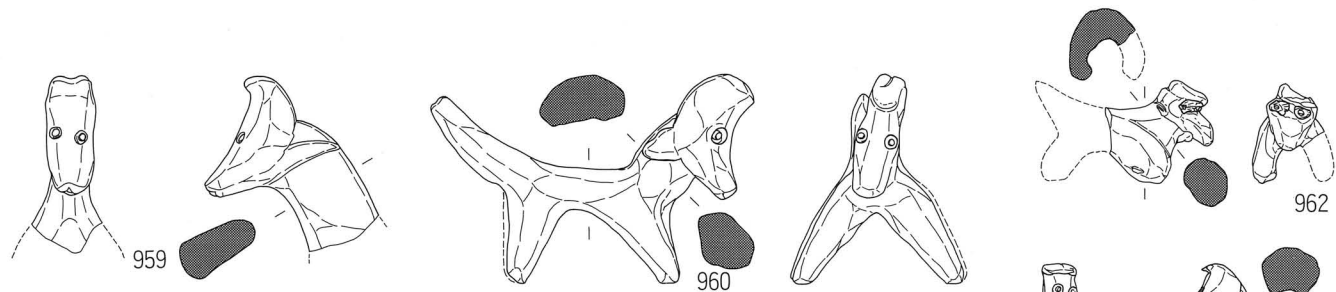
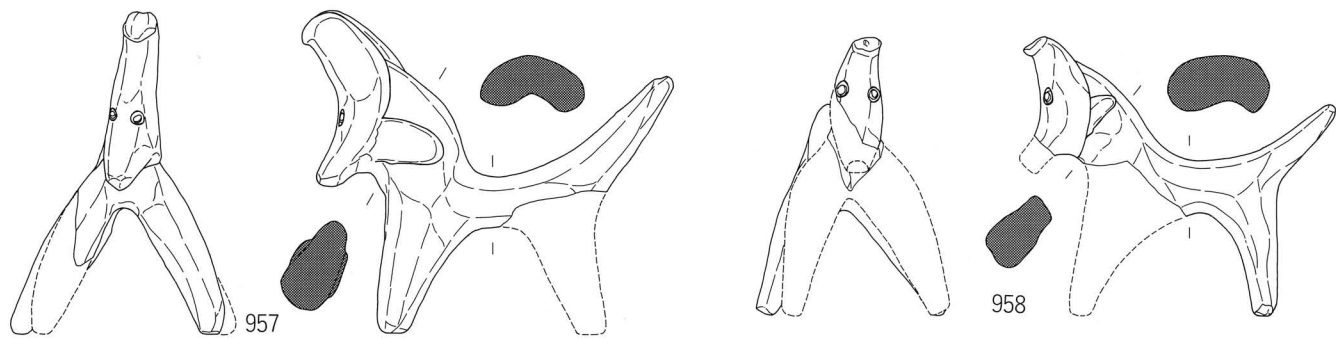
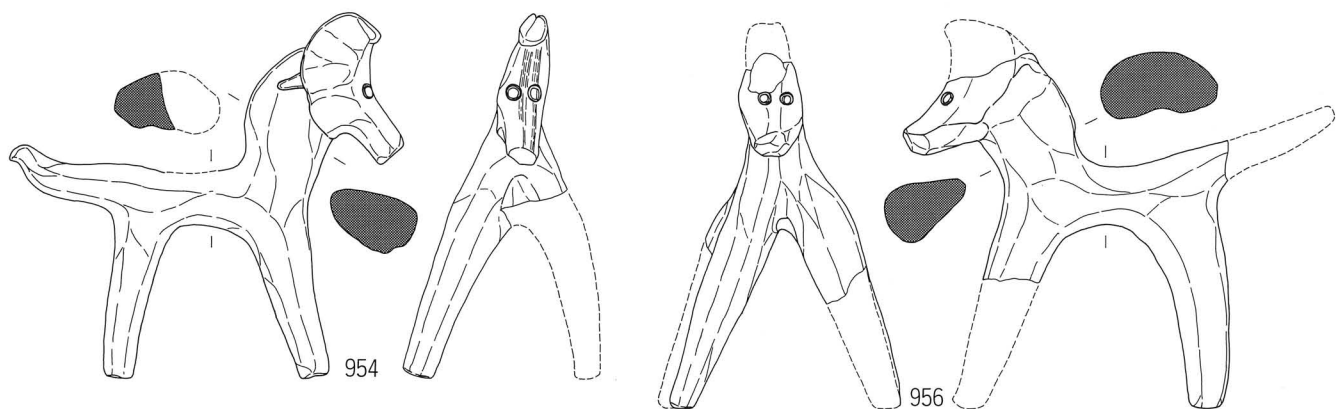
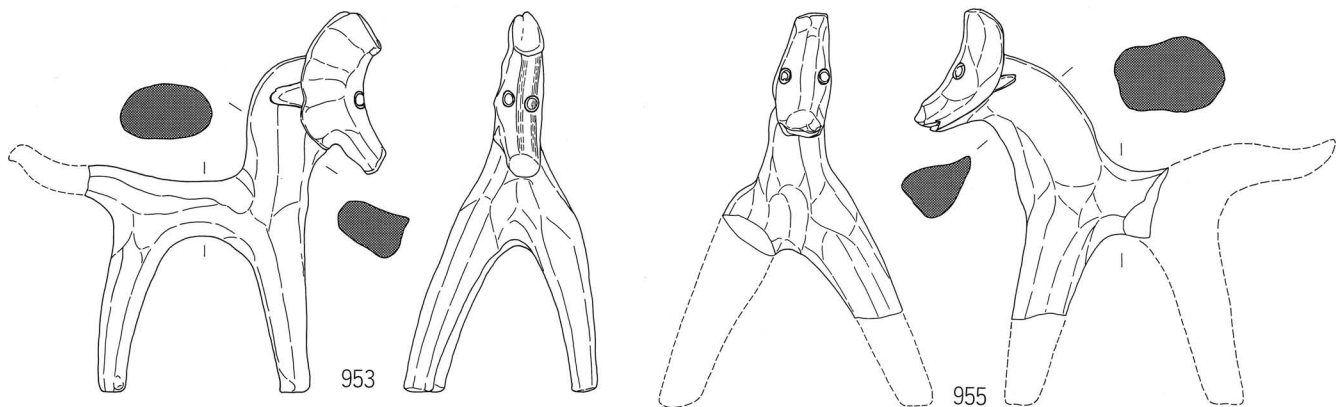

0 20cm

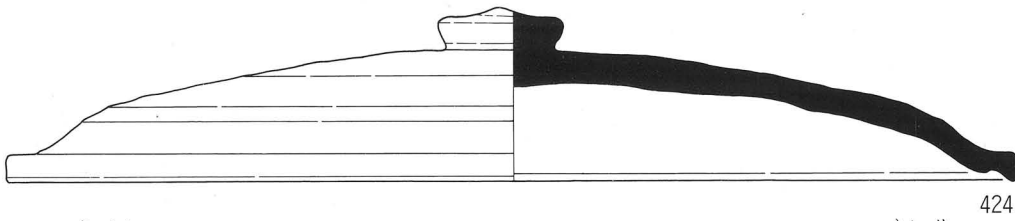

井

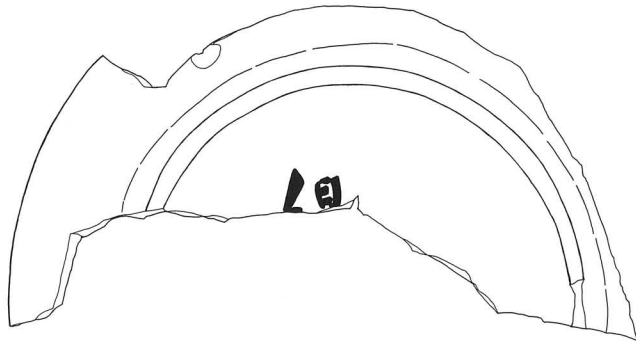
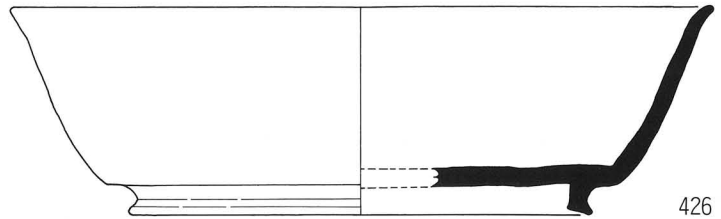
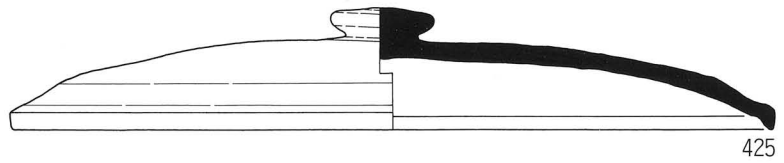
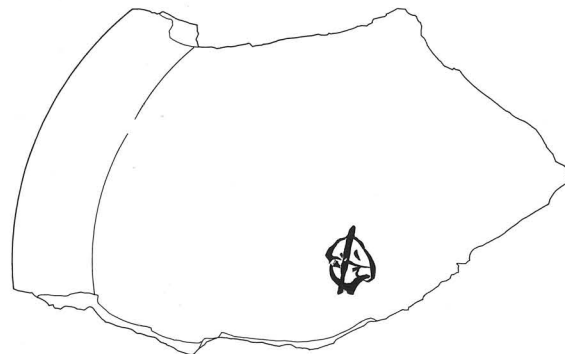
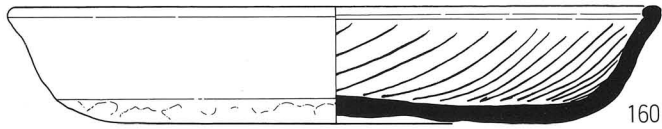
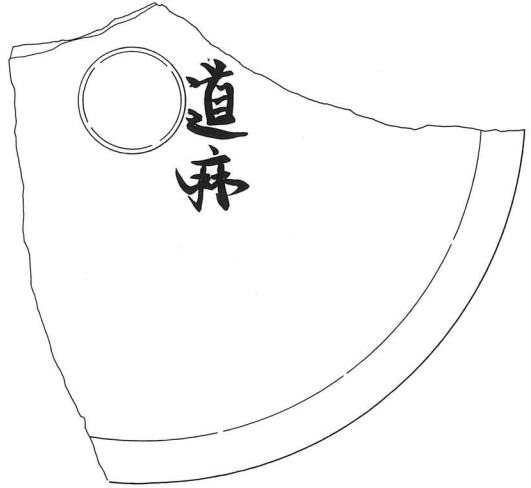
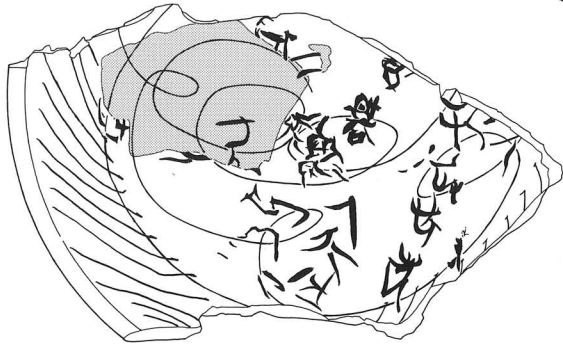

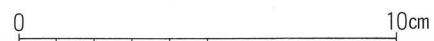
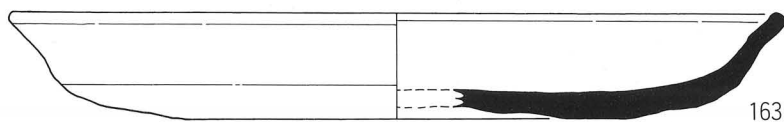
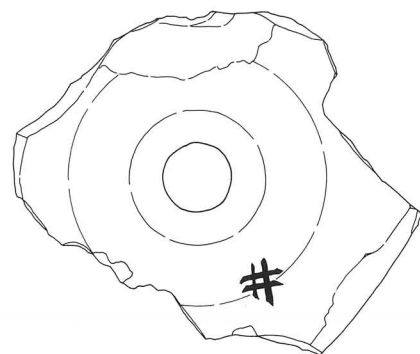
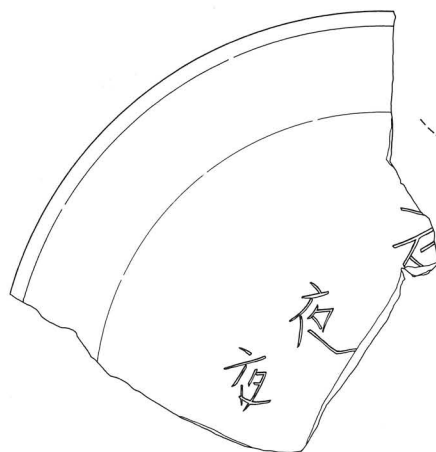
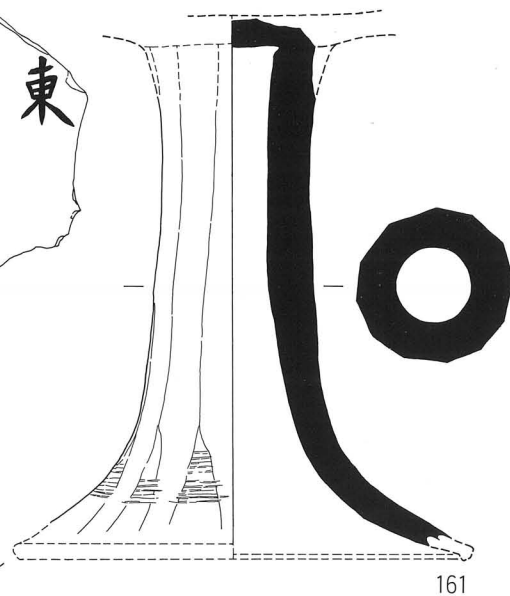
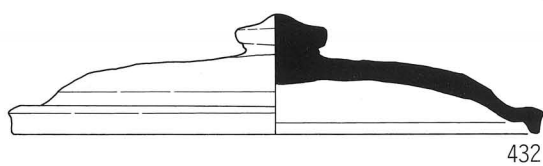
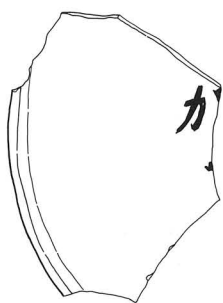
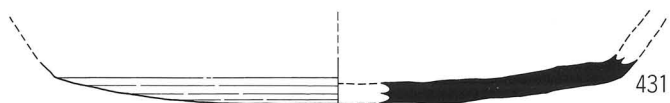
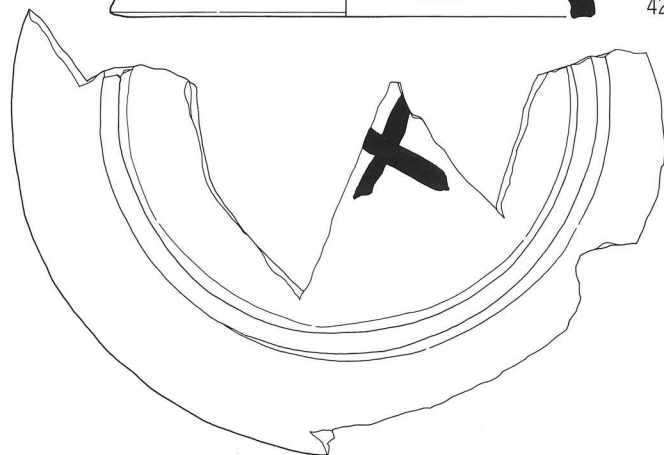
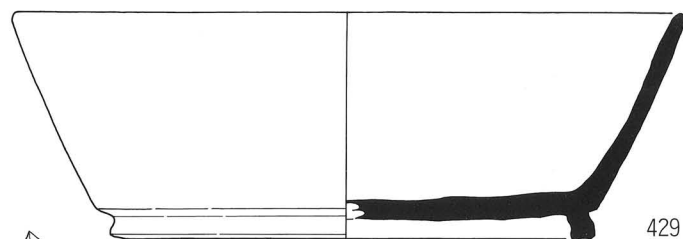
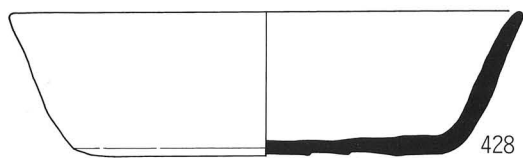

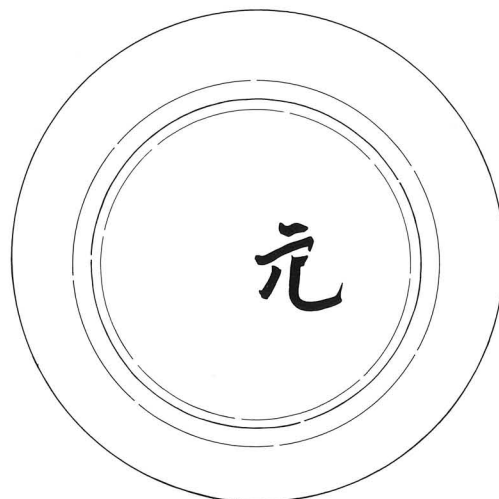
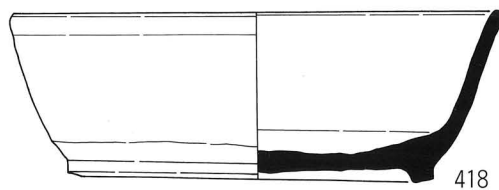
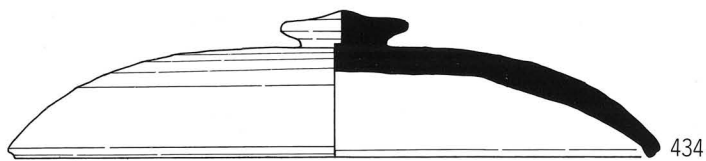
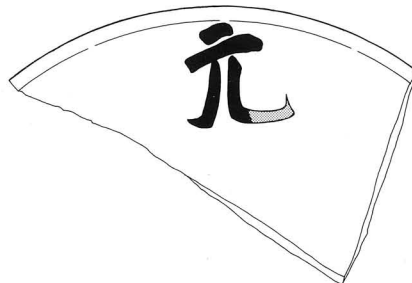
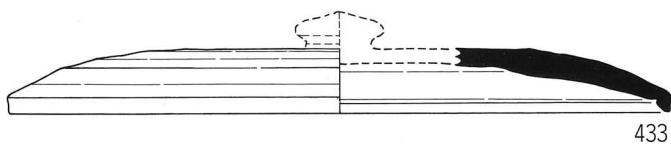
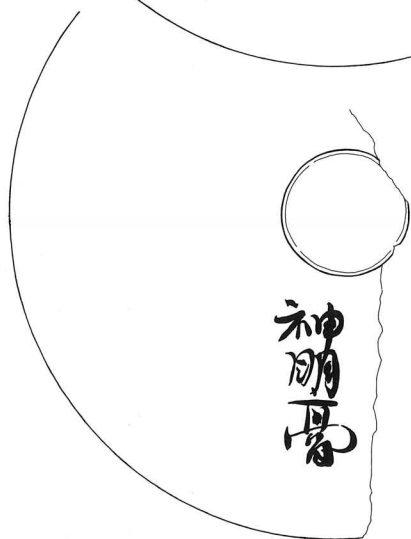
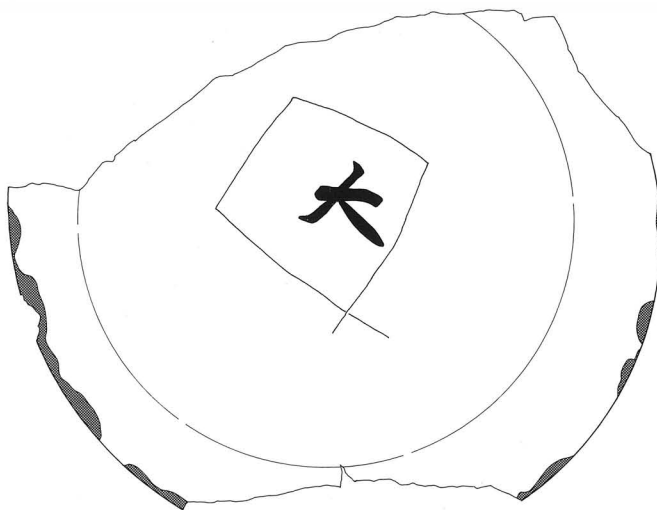
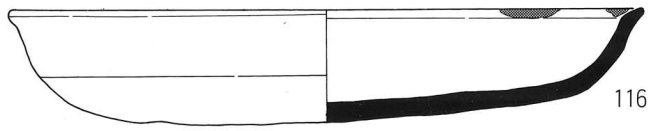
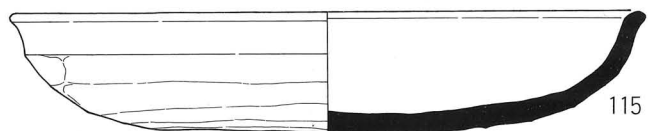



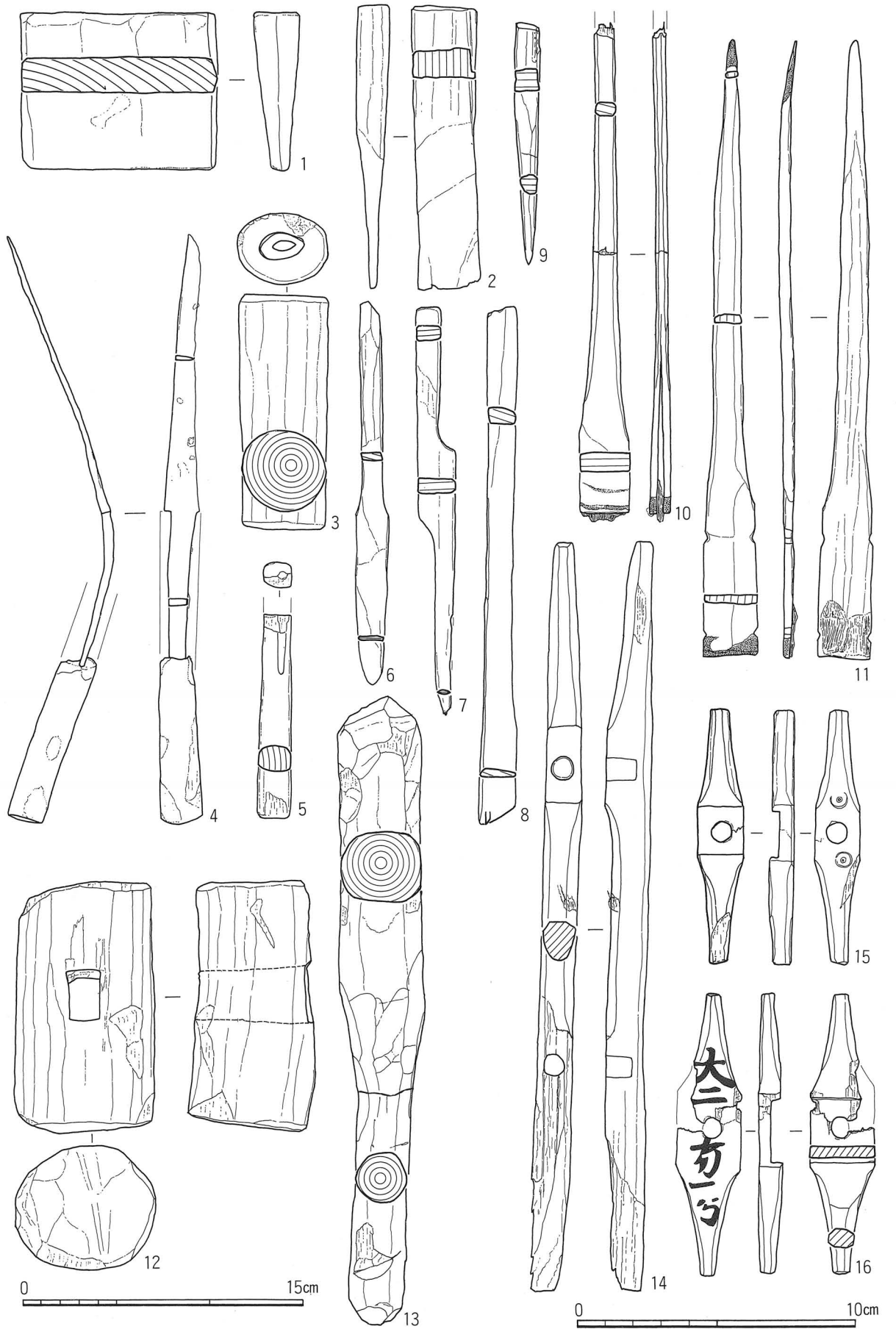

1~11・14~16 1:2 12・13 1:3

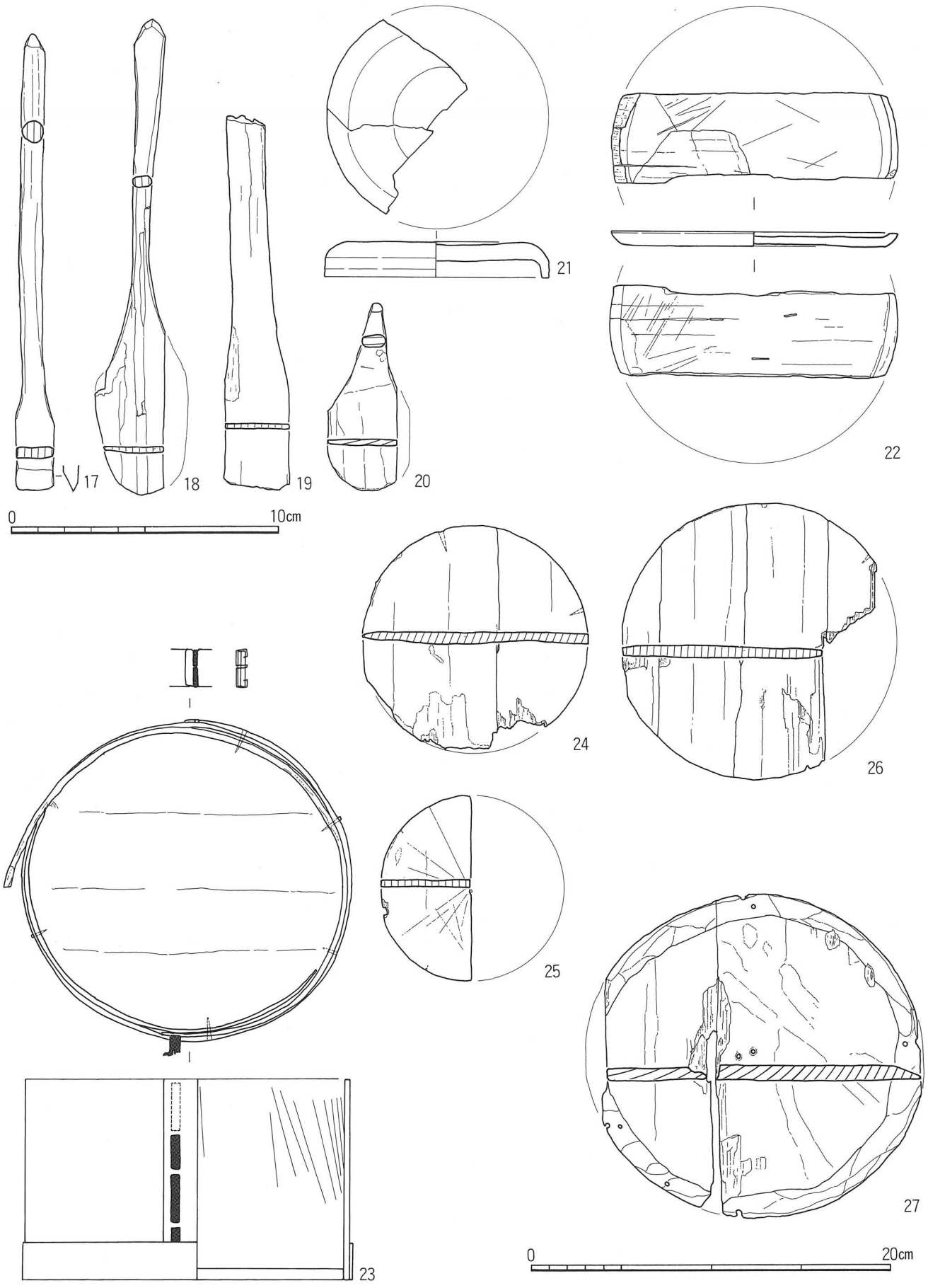

17~21 1:2 22~27 1:3

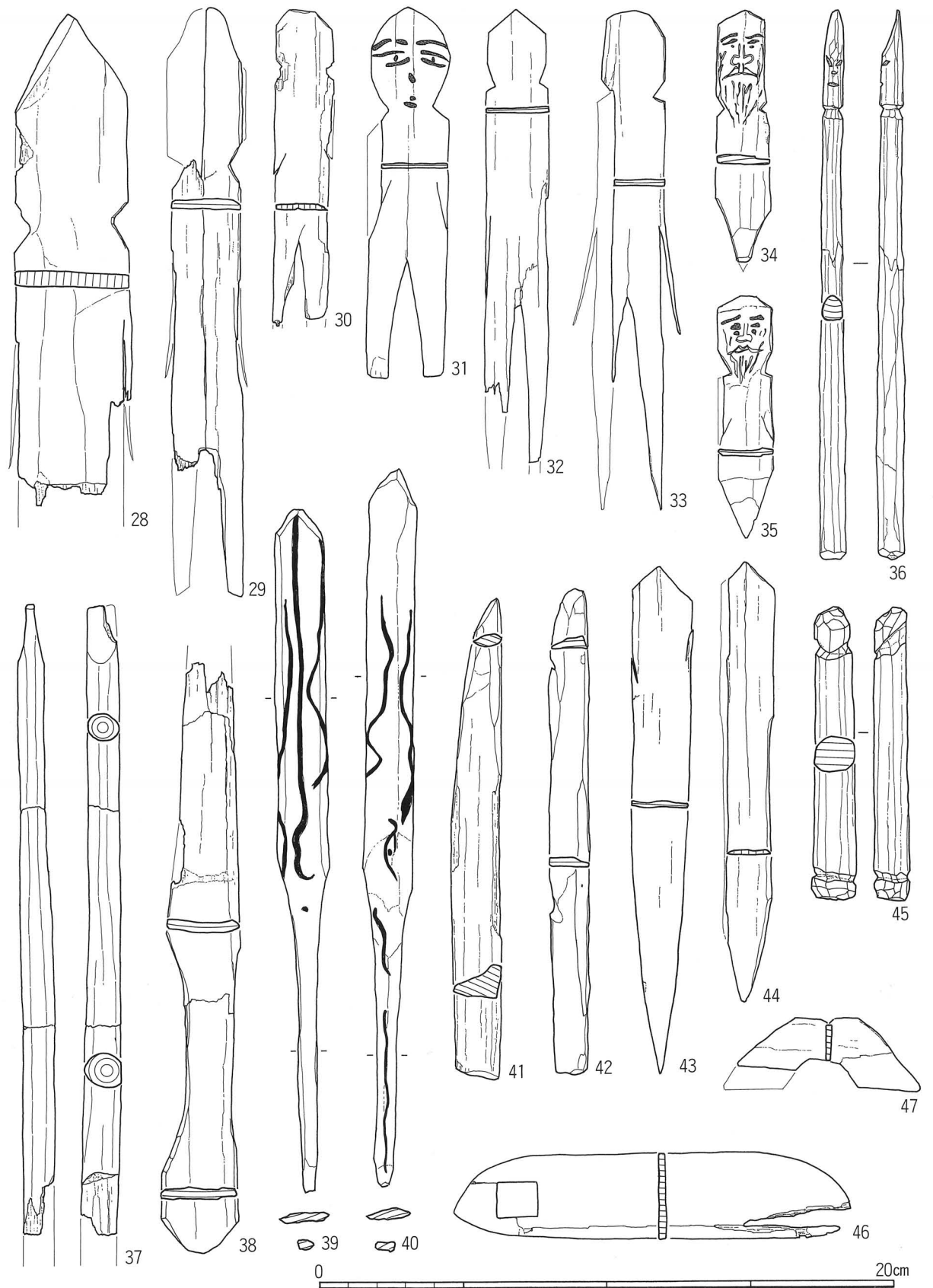

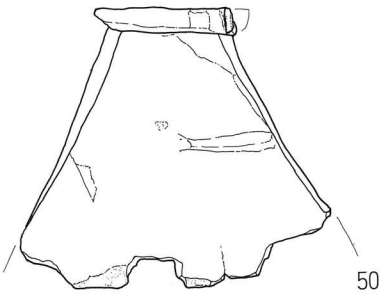
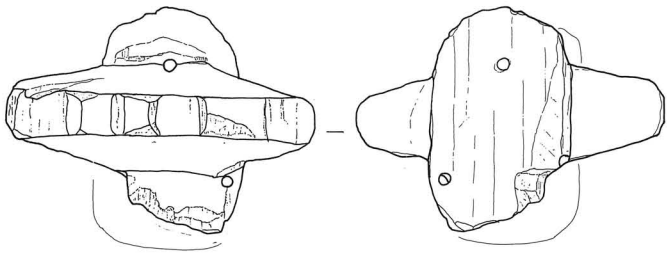

50

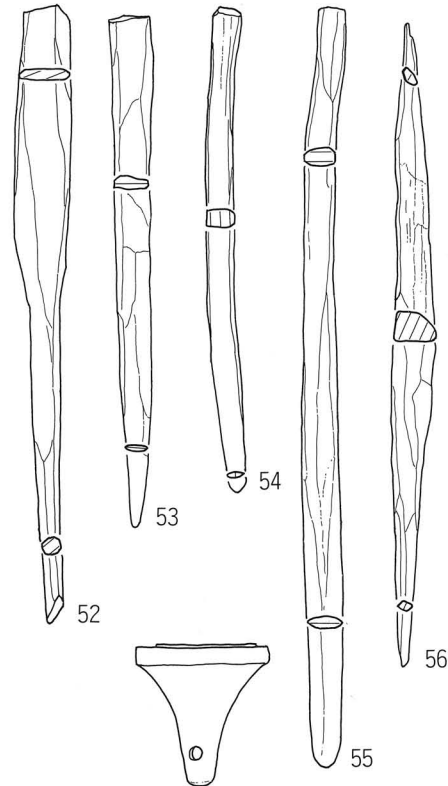

0 60 10cm

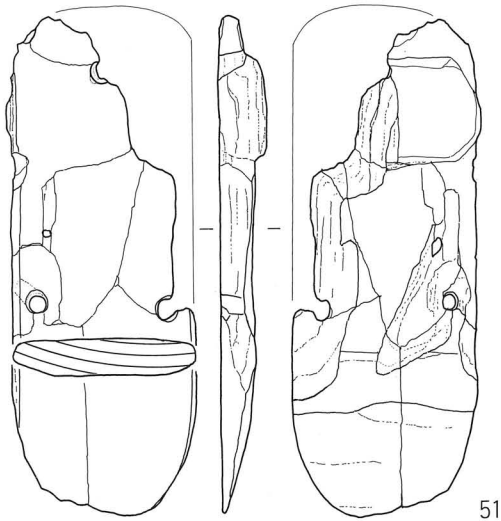

51

48~51 1:3

52~56・60 1:2

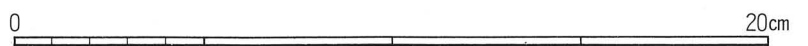
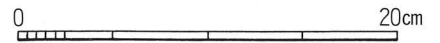
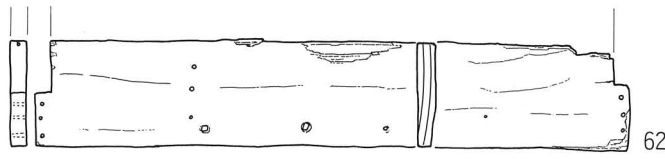
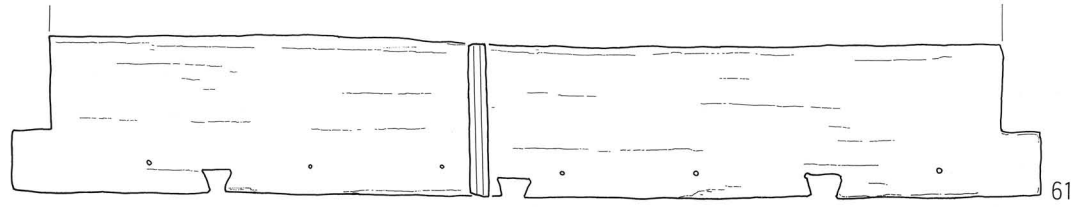

61・62 1:4 63~72 1:2

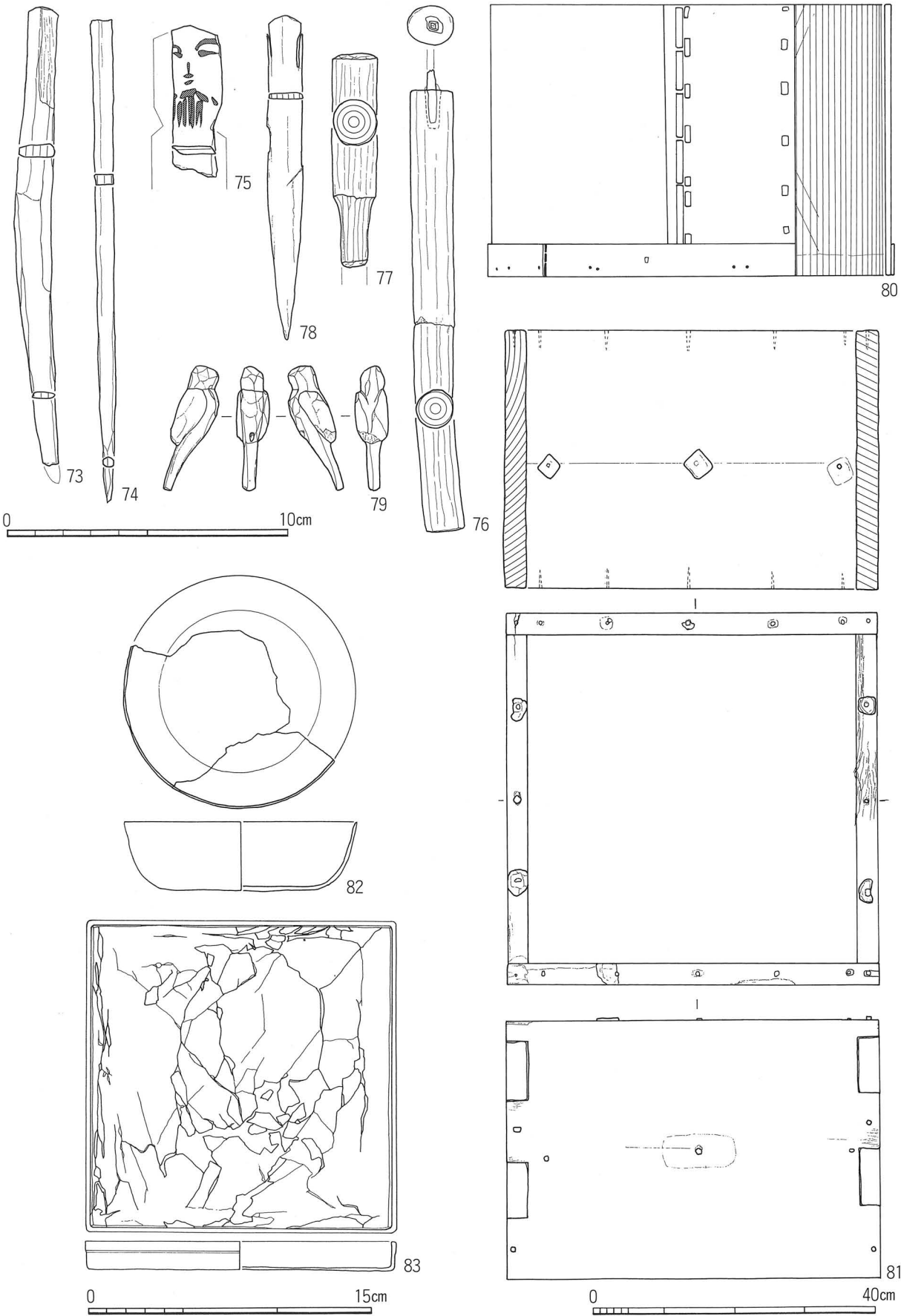

73~75-SD6451 76~81-SE6657 82・83-SX6428

73~79 1:2 80・81 1:8 82・83 1:3

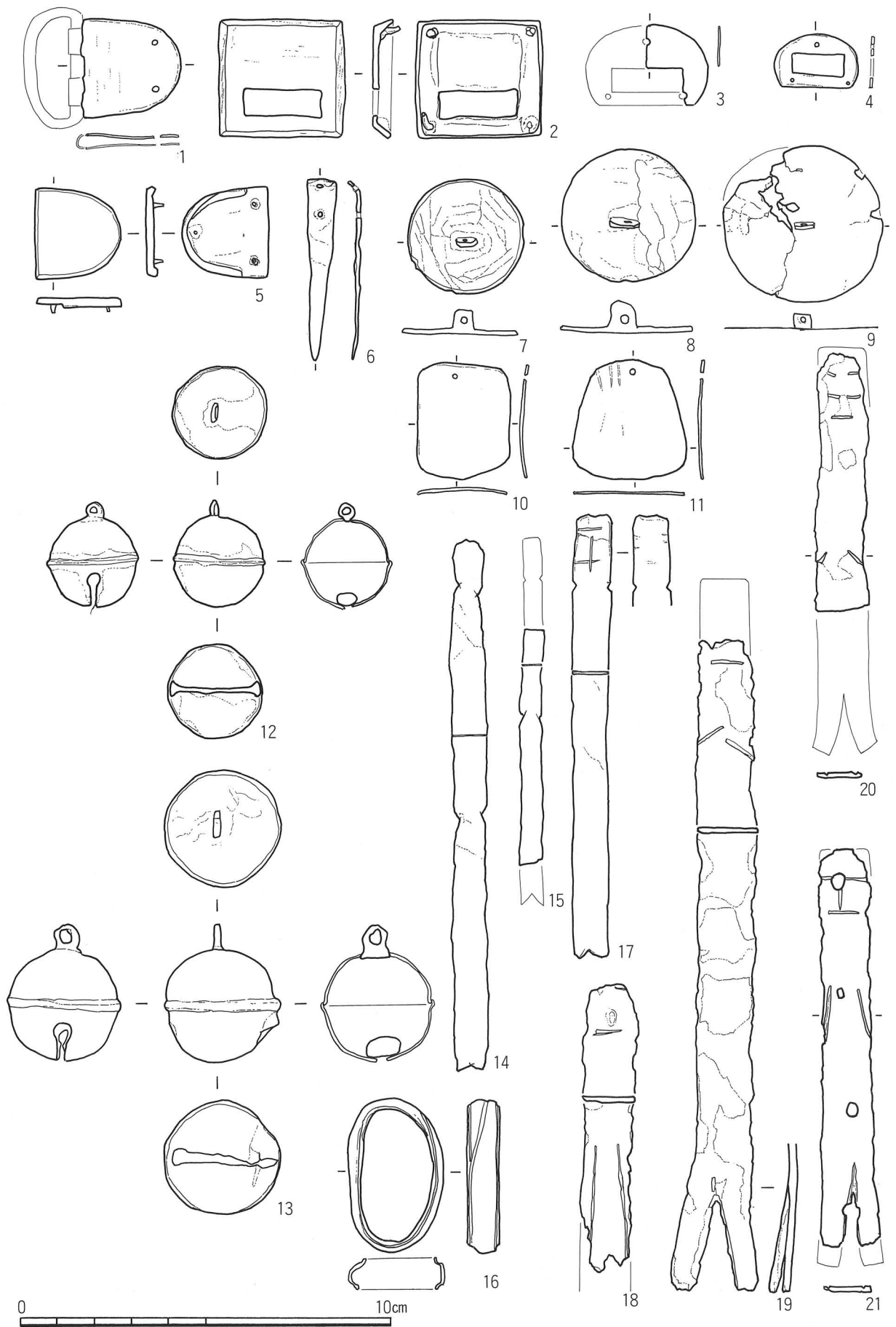

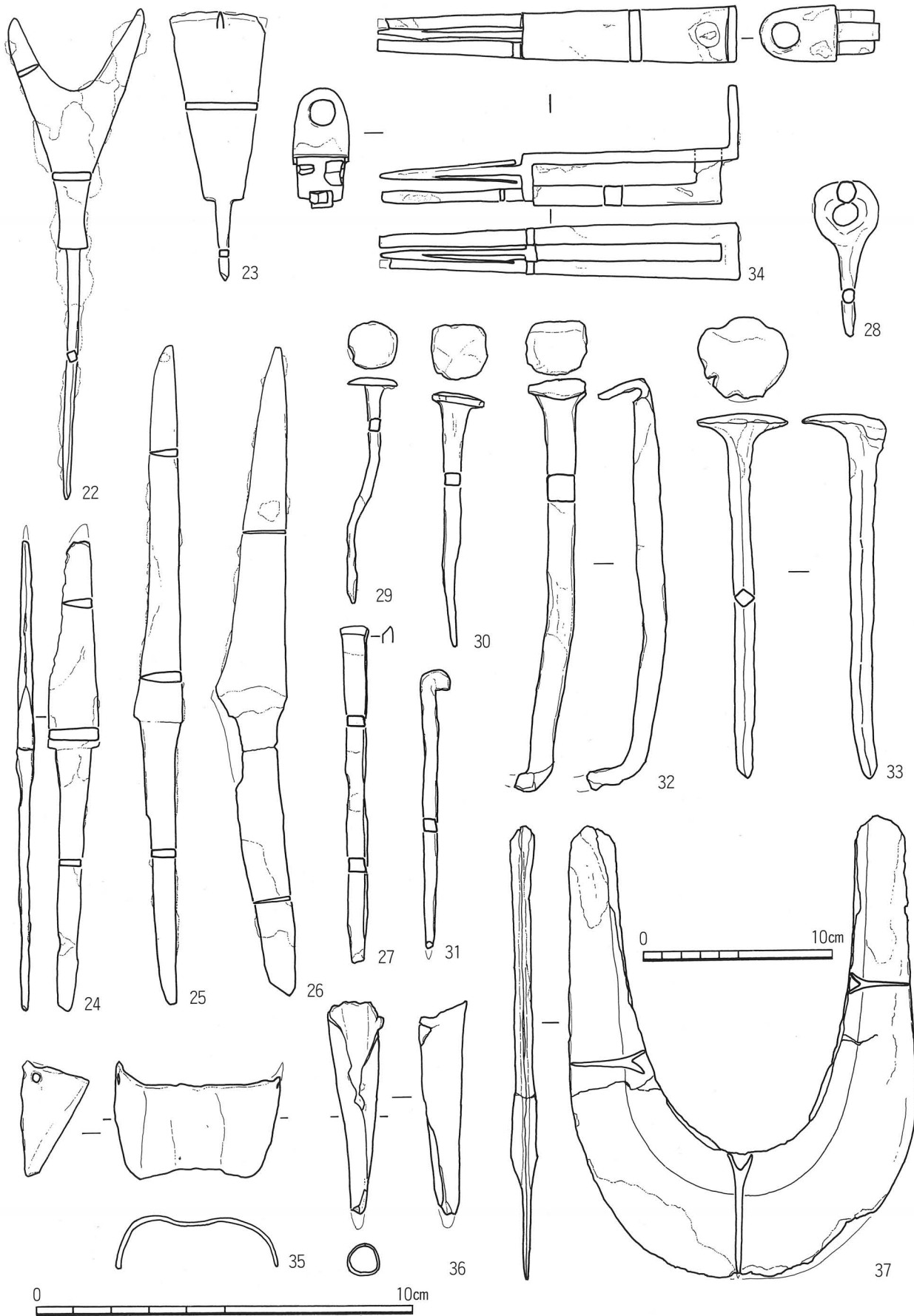

22~27・29~37-SD6400 28-遺物包含層 22~36 2:3 37 1:3



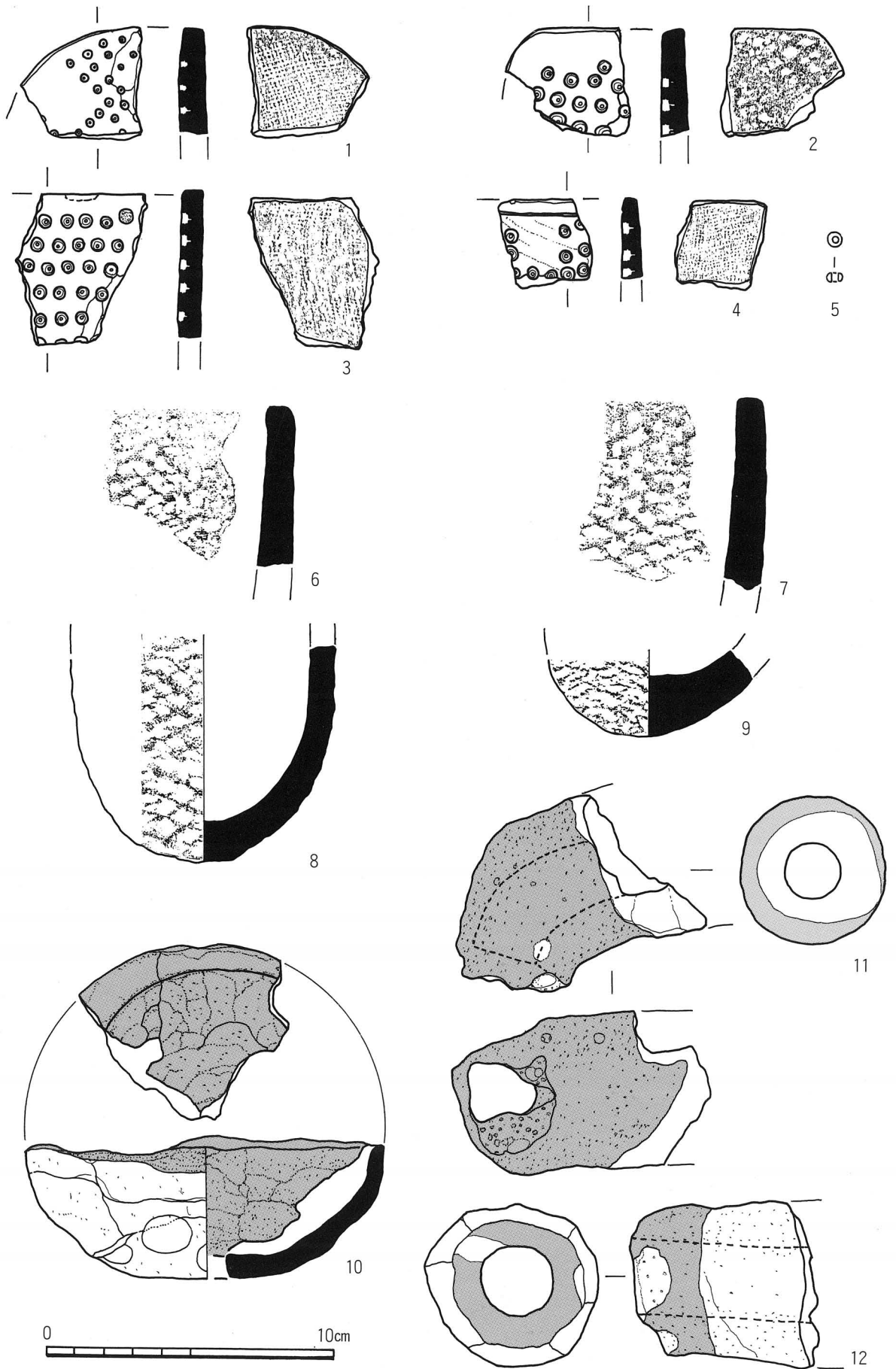

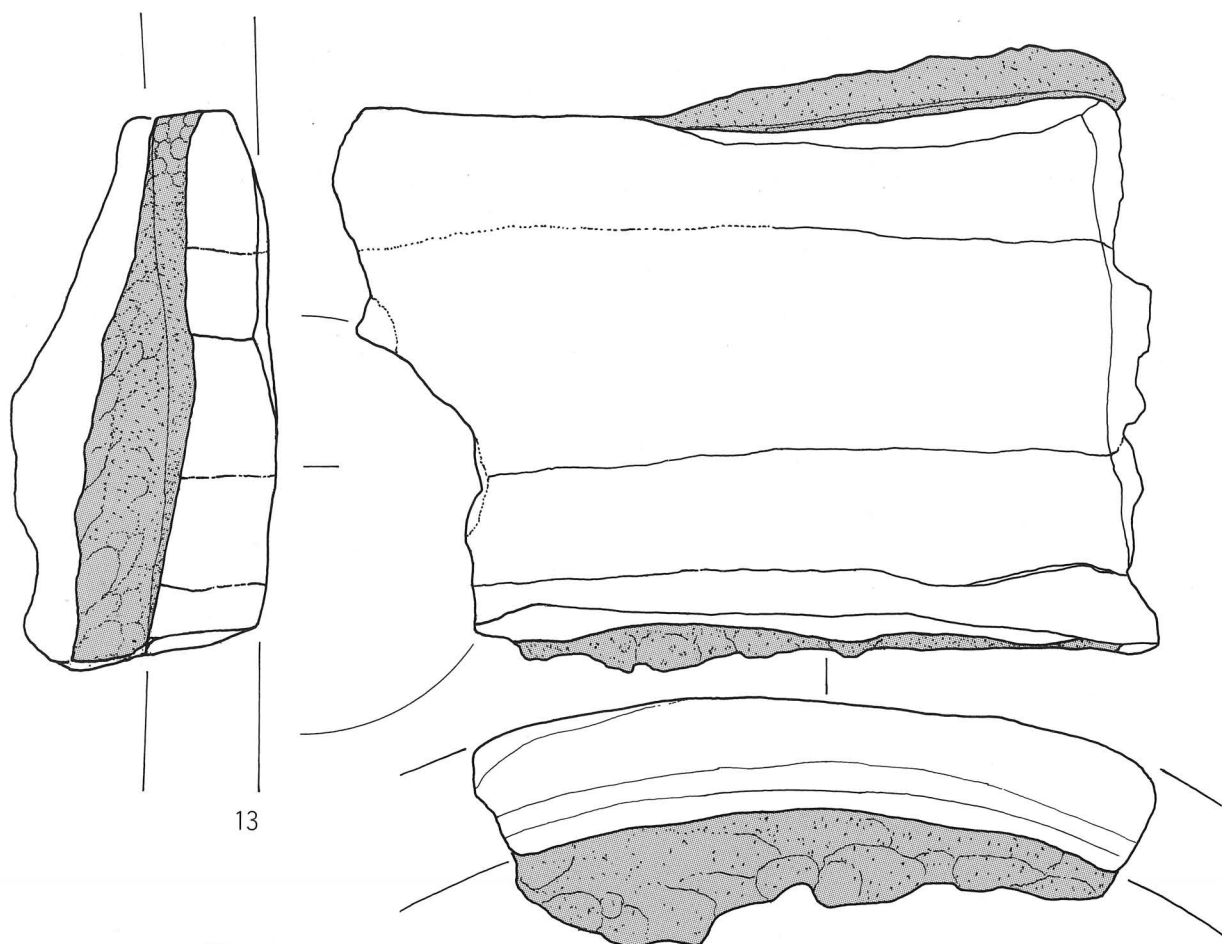

13

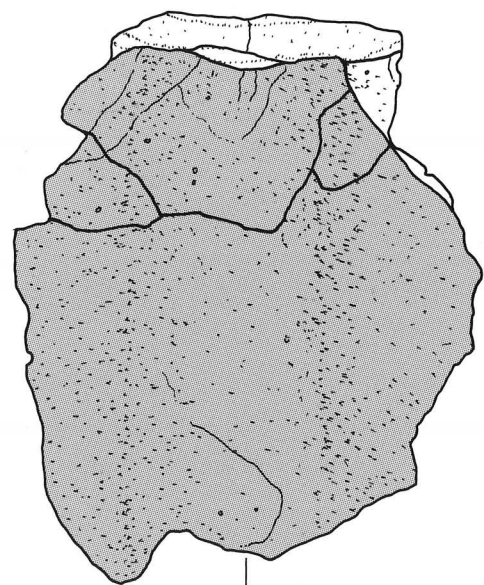

14

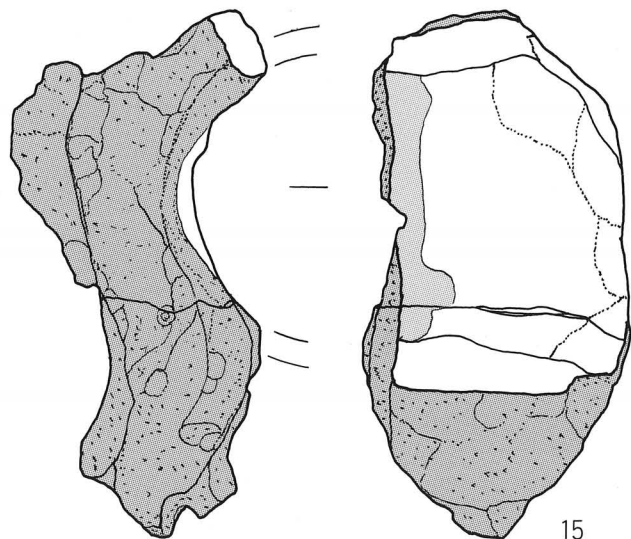

15

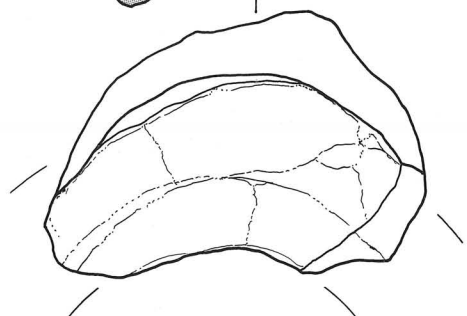

1:2

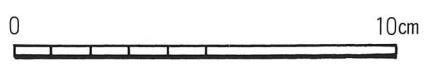



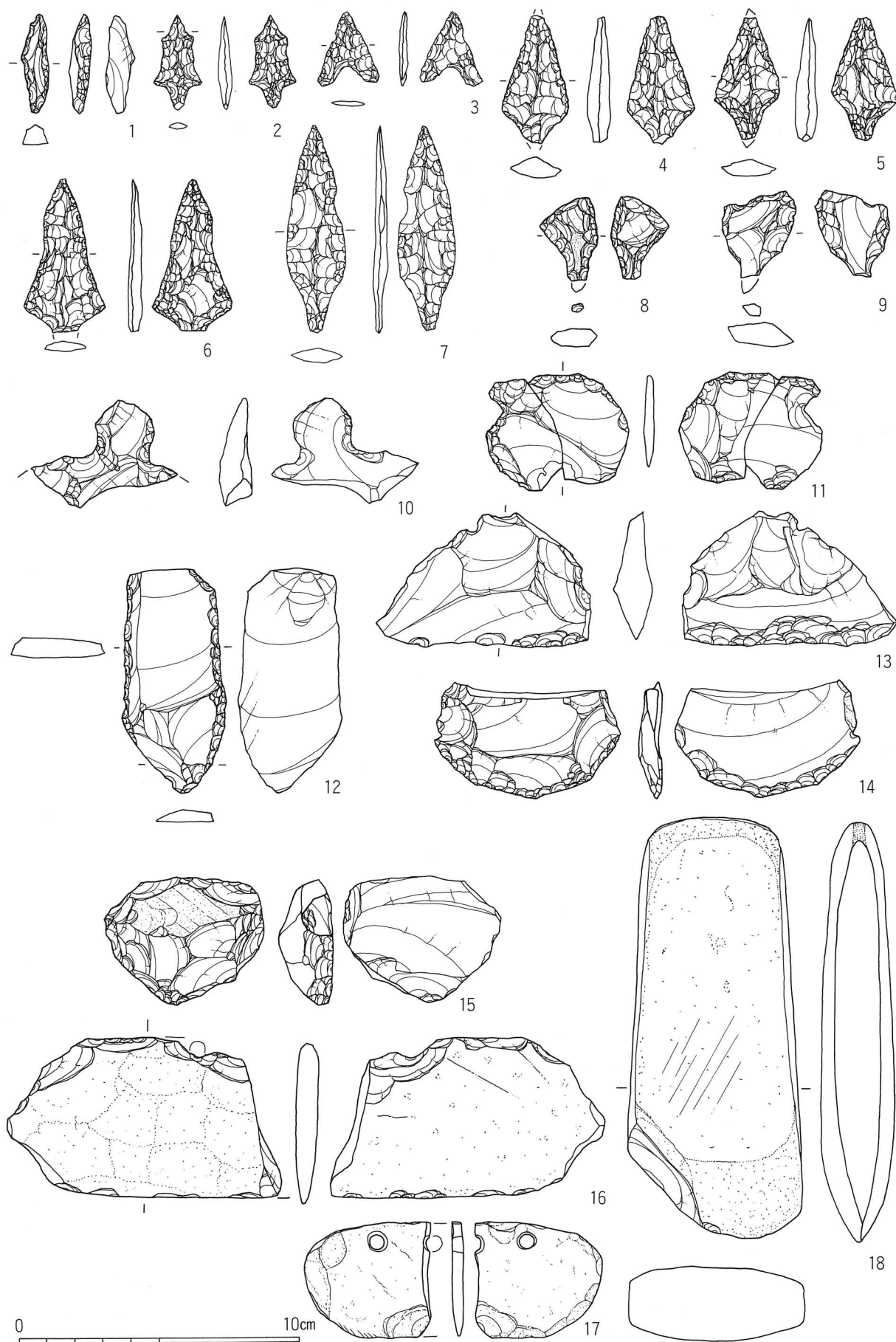

0 10cm

1:2