

1 : 8 (38・39・41は1 : 6)

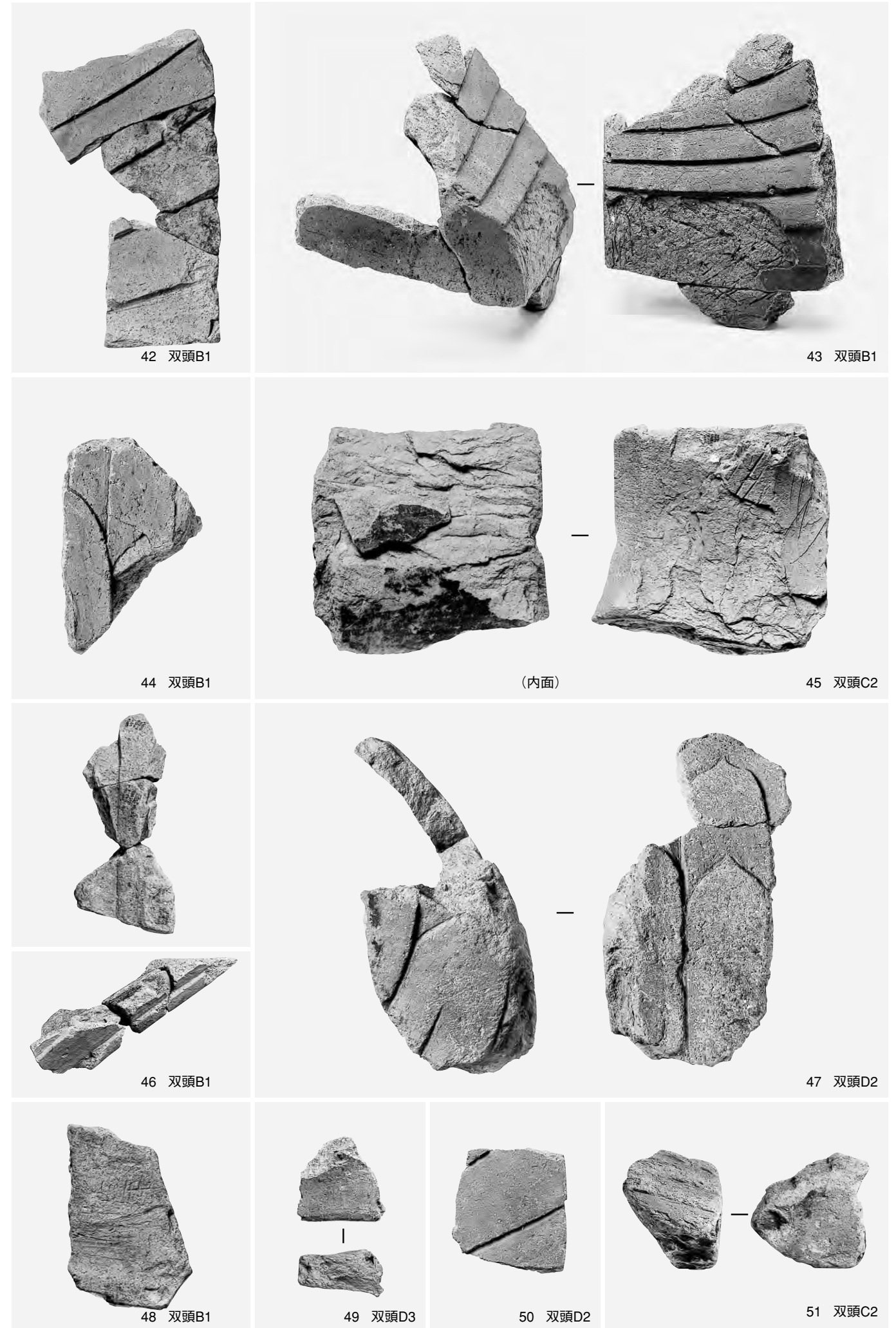

1 : 6

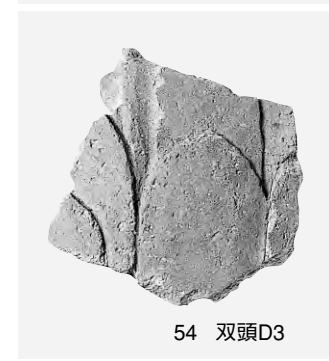

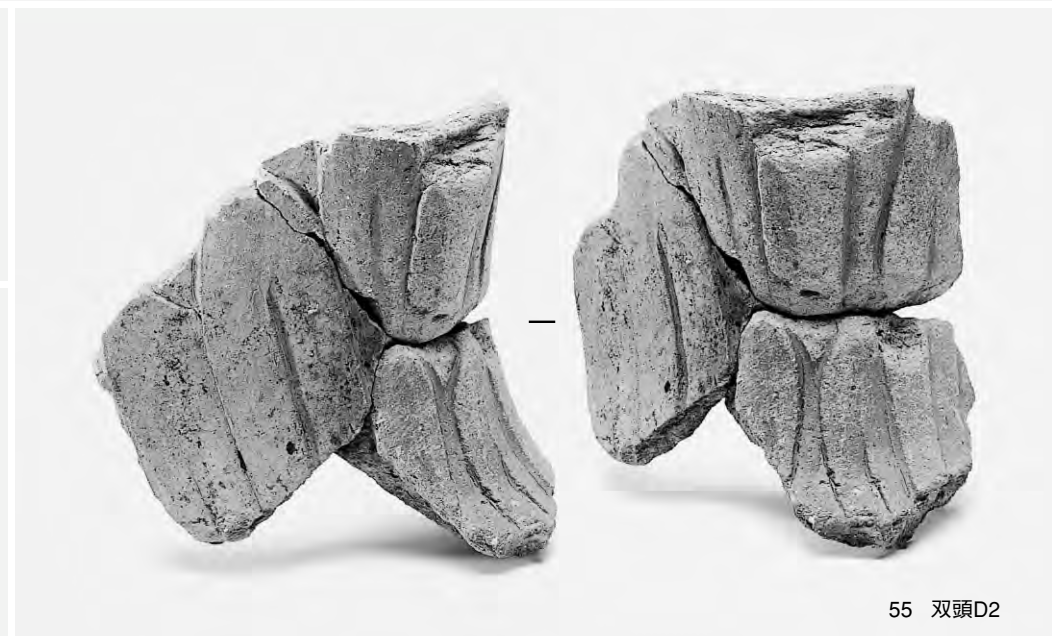
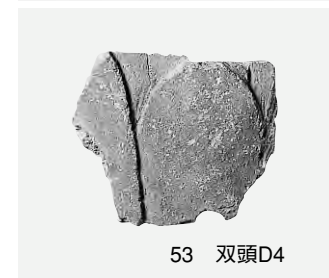
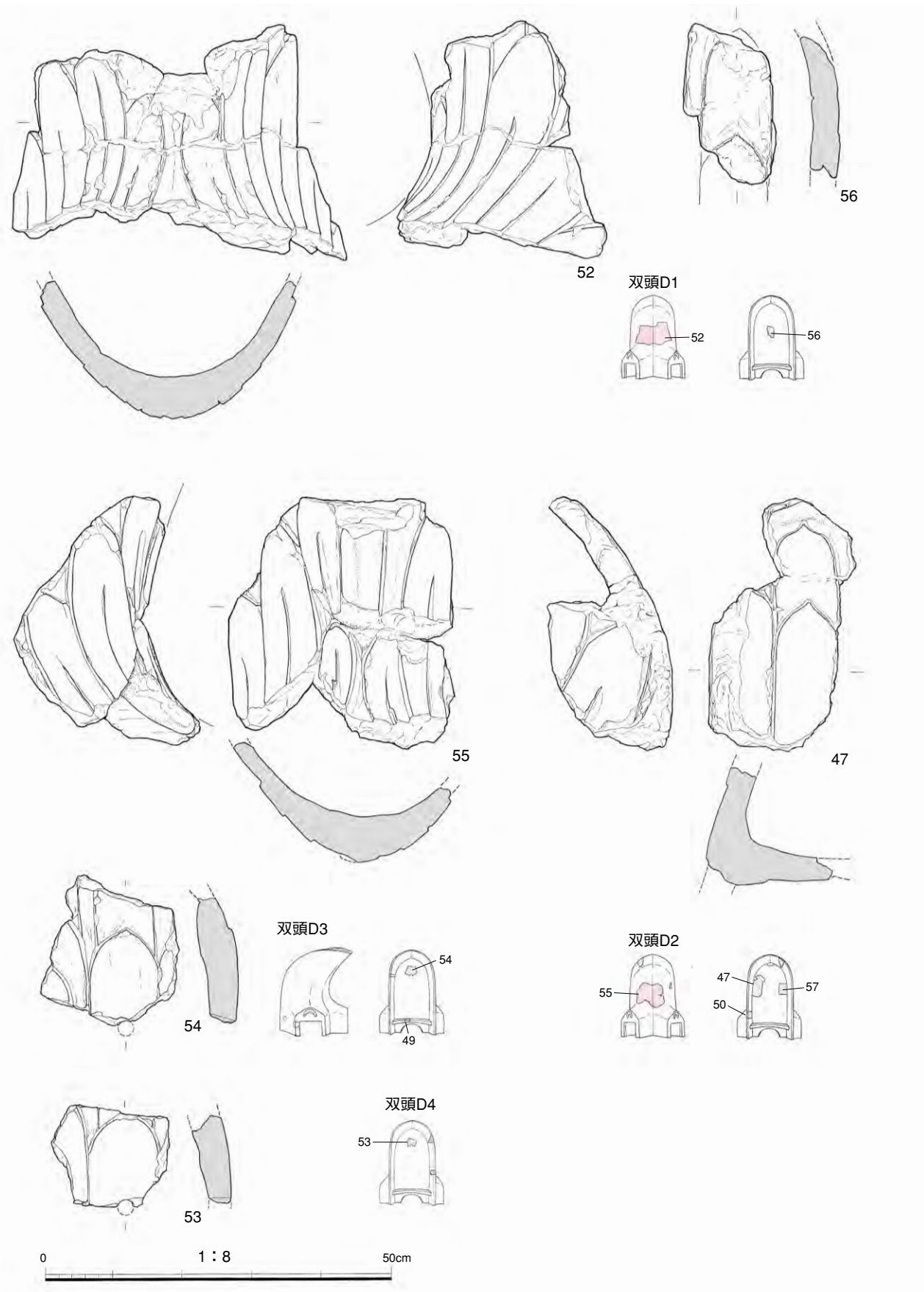
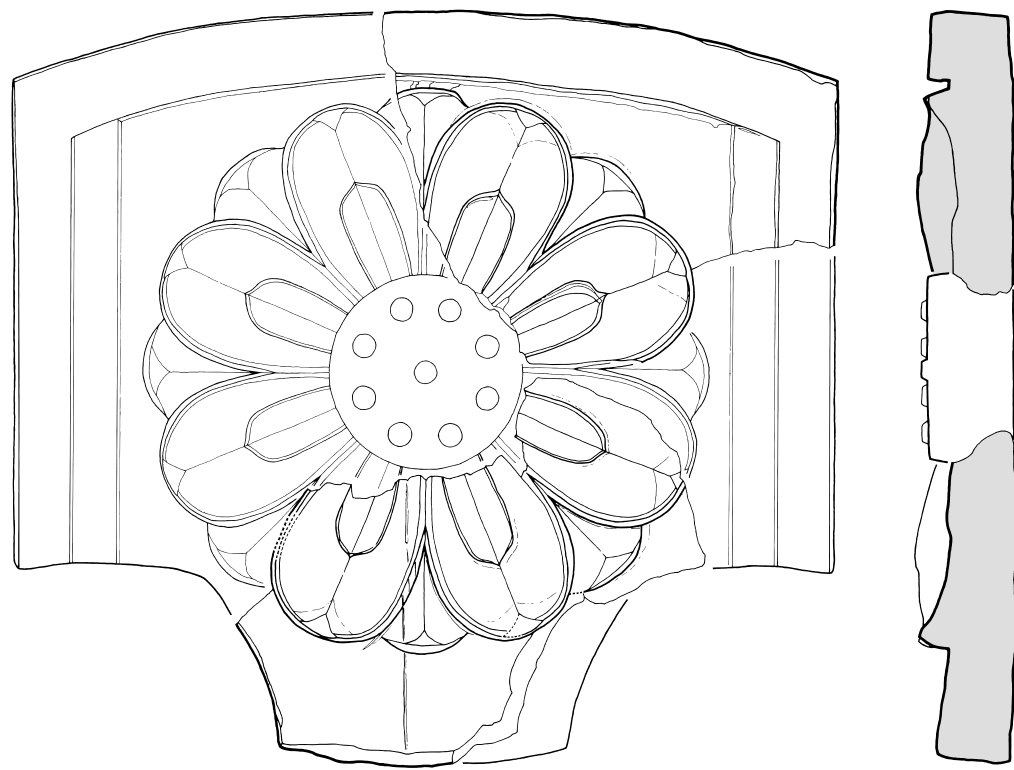

1 蓮華文A



1 蓮華文A

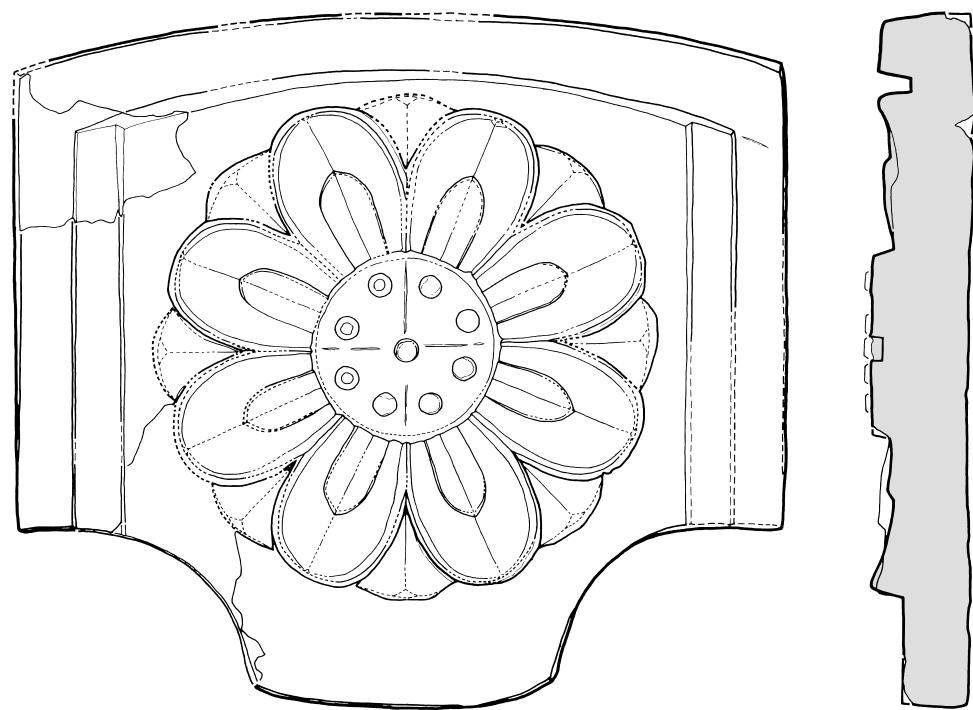

2 蓮華文B

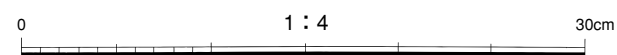

2 蓮華文B

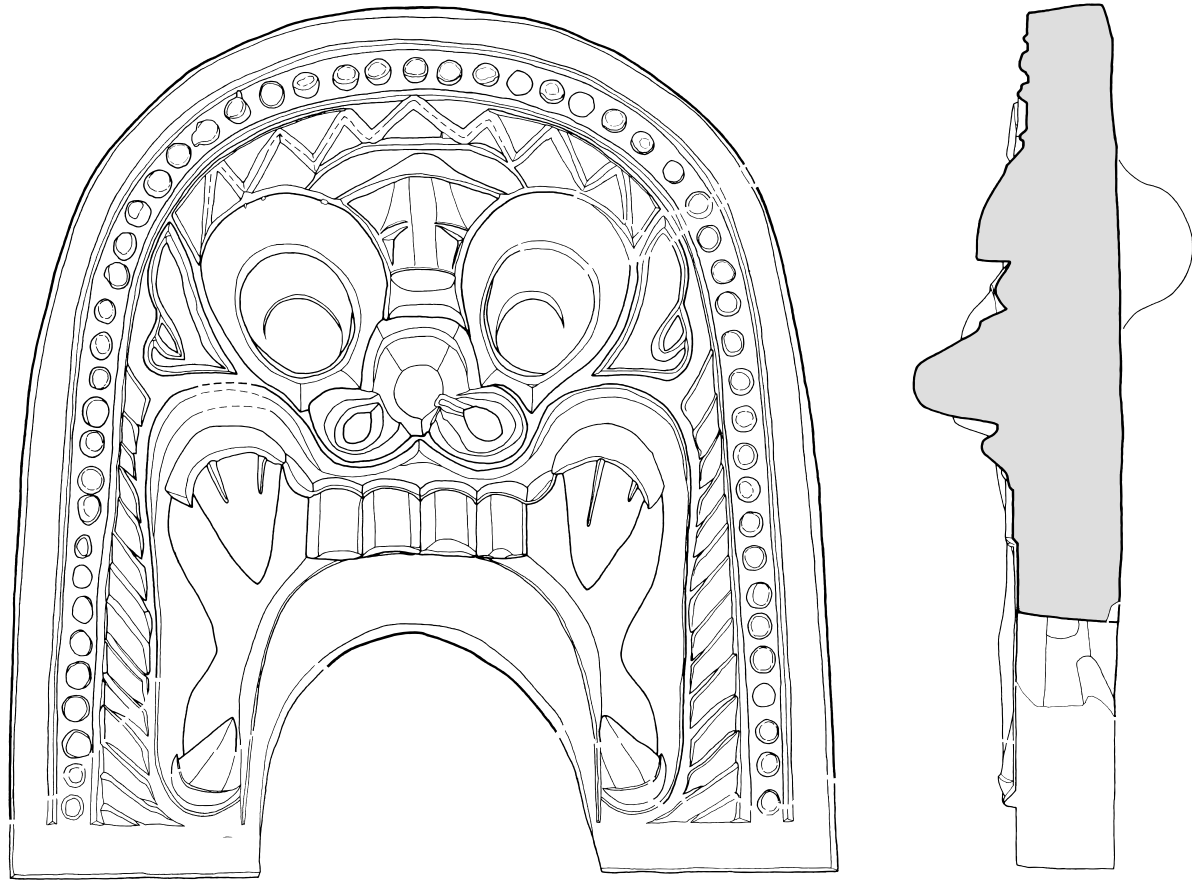

1 鬼面文A

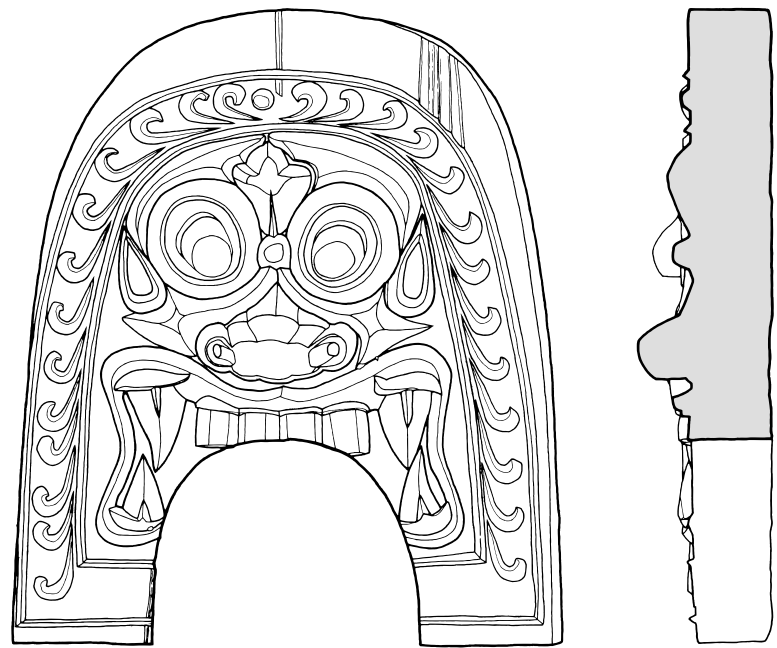

5 鬼面文B

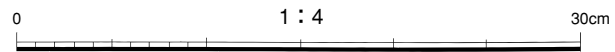

1 鬼面文A



2 鬼面文A



3 鬼面文A



4 鬼面文A

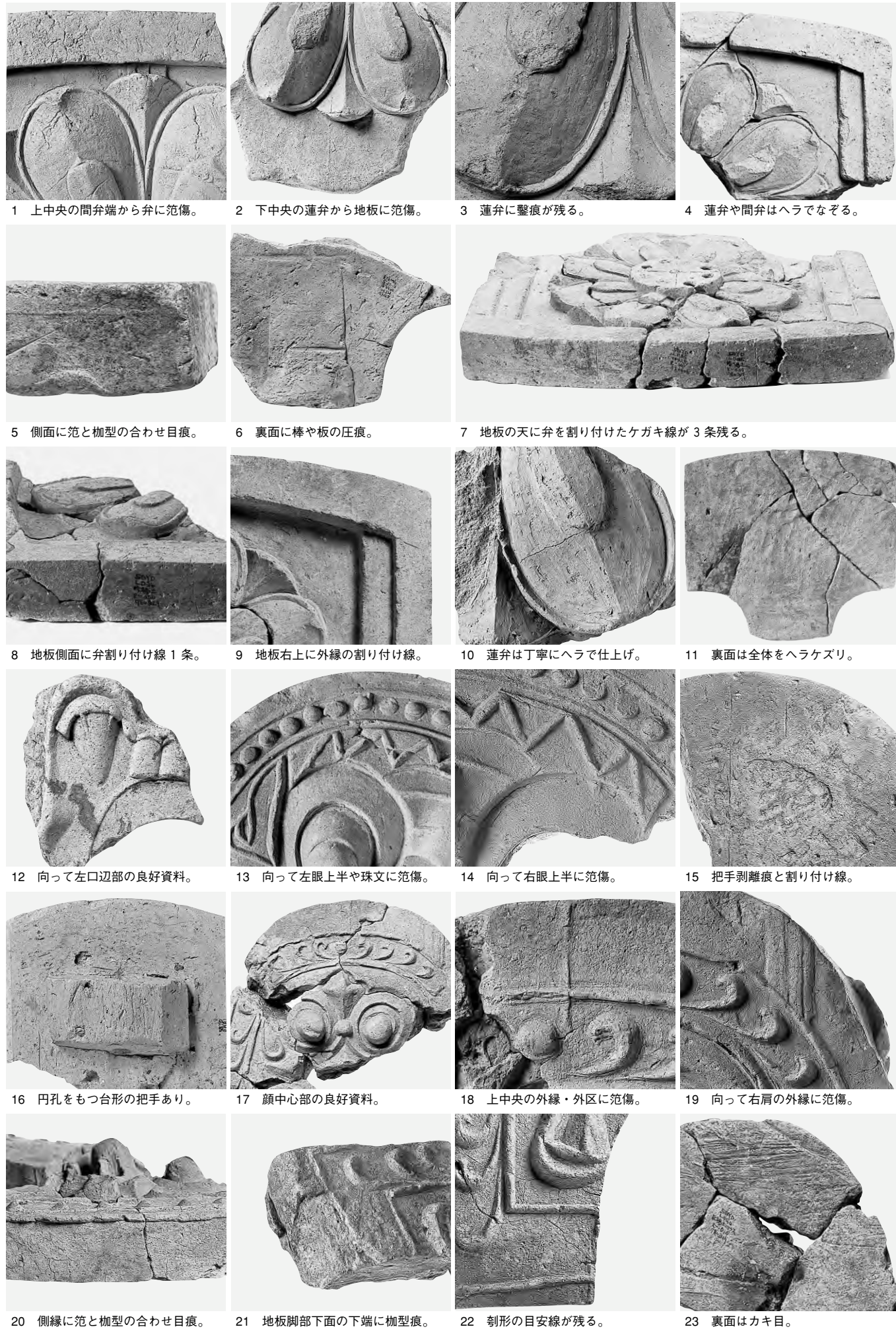

1 上中央の間弁端から弁に范傷。 2 下中央の蓮弁から地板に范傷。 3 蓮弁に鑿痕が残る。 4 蓮弁や間弁はヘラでなぞる。
 5 側面に范と枷型の合わせ目痕。 6 裏面に棒や板の圧痕。 7 地板の天に弁を割り付けたケガキ線が3条残る。
 8 地板側面に弁割り付け線1条。 9 地板右上に外縁の割り付け線。 10 蓮弁は丁寧にヘラで仕上げ。 11 裏面は全体をヘラケズリ。
 12 向って左口辺部の良好資料。 13 向って左眼上半や珠文に范傷。 14 向って右眼上半に范傷。 15 把手剥離痕と割り付け線。
 16 円孔をもつ台形の把手あり。 17 顔中心部の良好資料。 18 上中央の外縁・外区に范傷。 19 向って右肩の外縁に范傷。
 20 側縁に范と枷型の合わせ目痕。 21 地板脚部下面の下端に枷型痕。 22 割形の目安線が残る。 23 裏面はカキ目。



1 鬼面文鬼瓦B 2 鬼面文鬼瓦B
 3 鬼面文鬼瓦C 4 鬼面文鬼瓦D
 5 用途不明品 6 用途不明品 7 用途不明品
 8 隅木蓋瓦



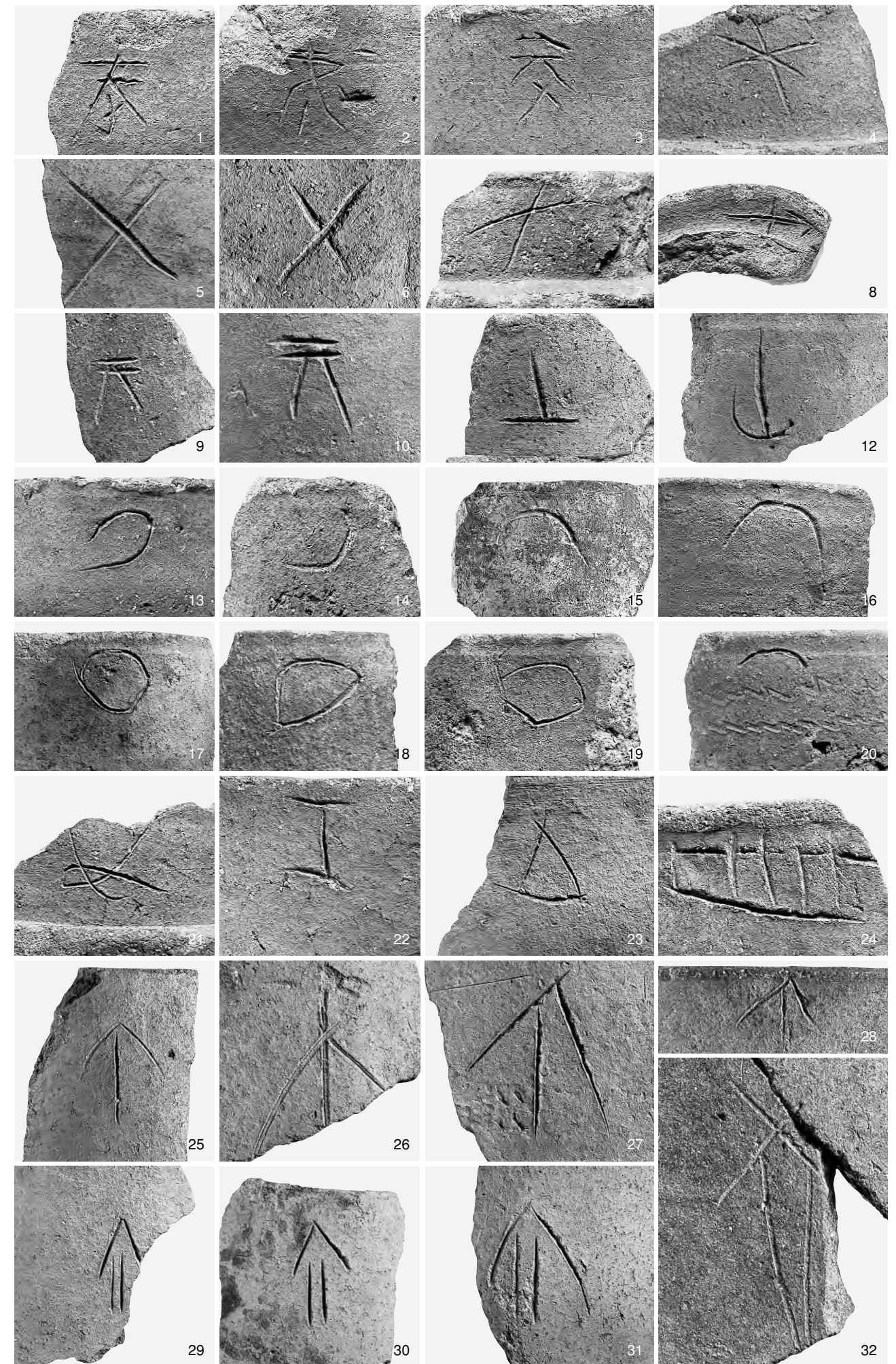
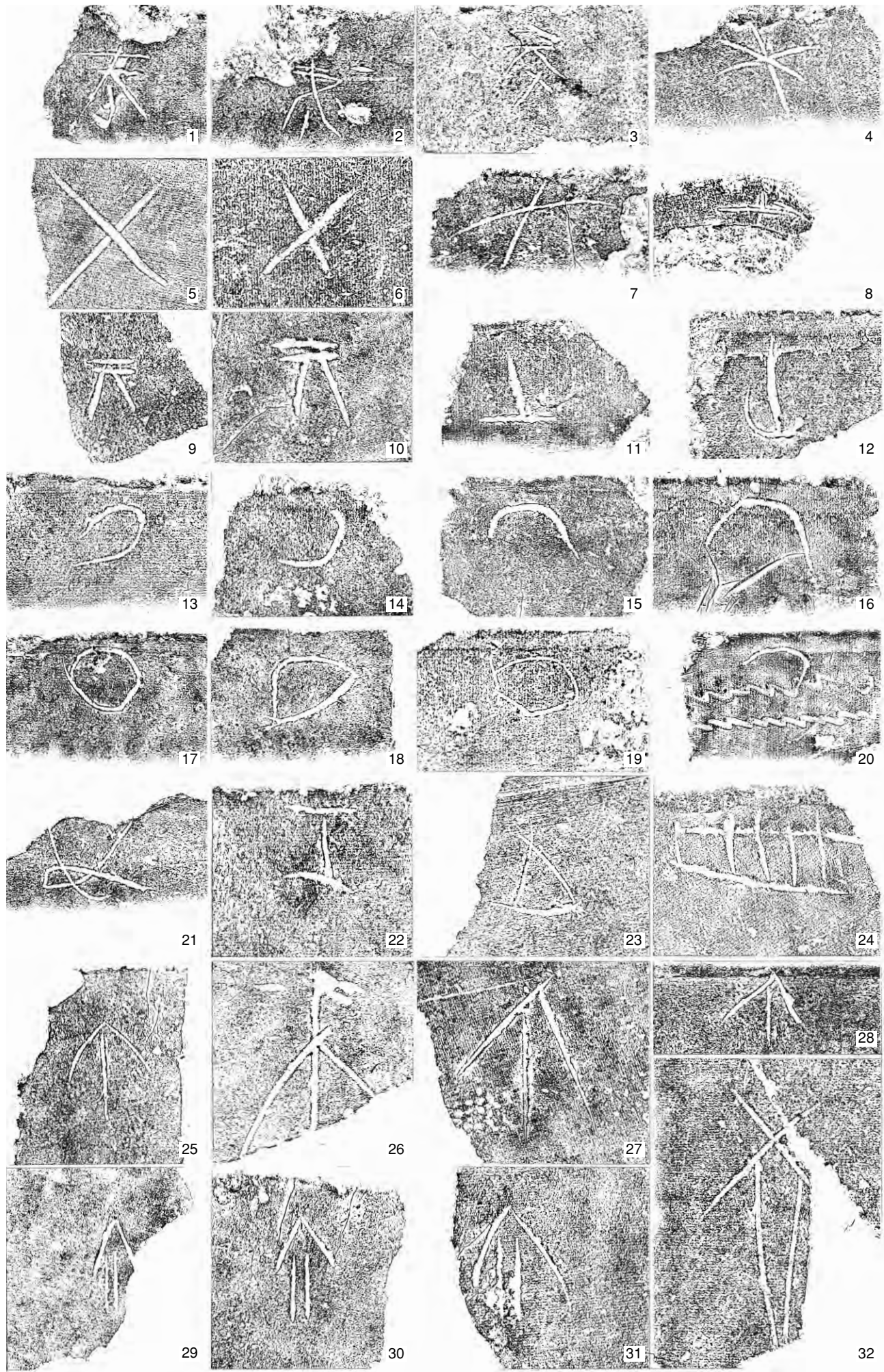

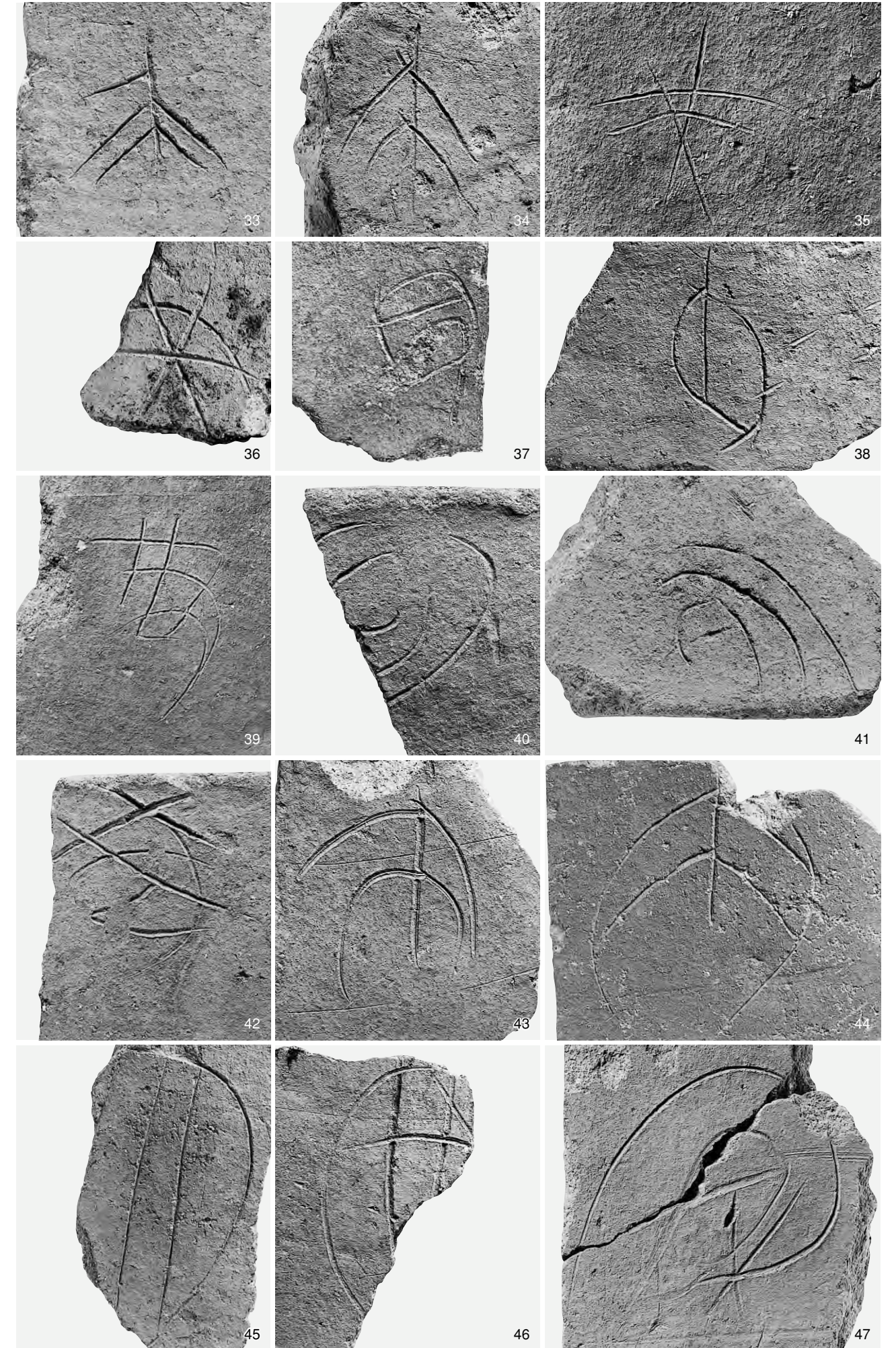
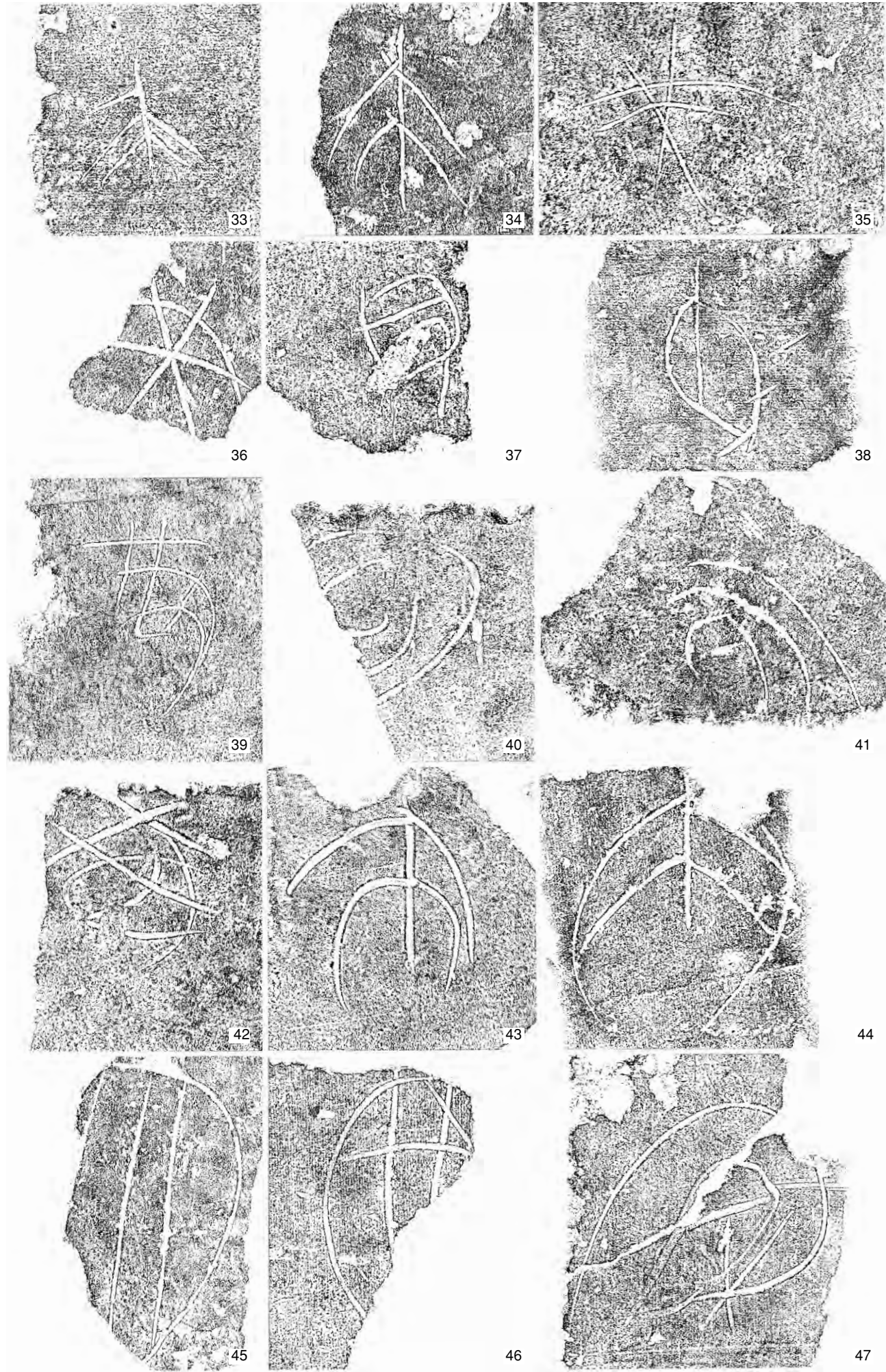

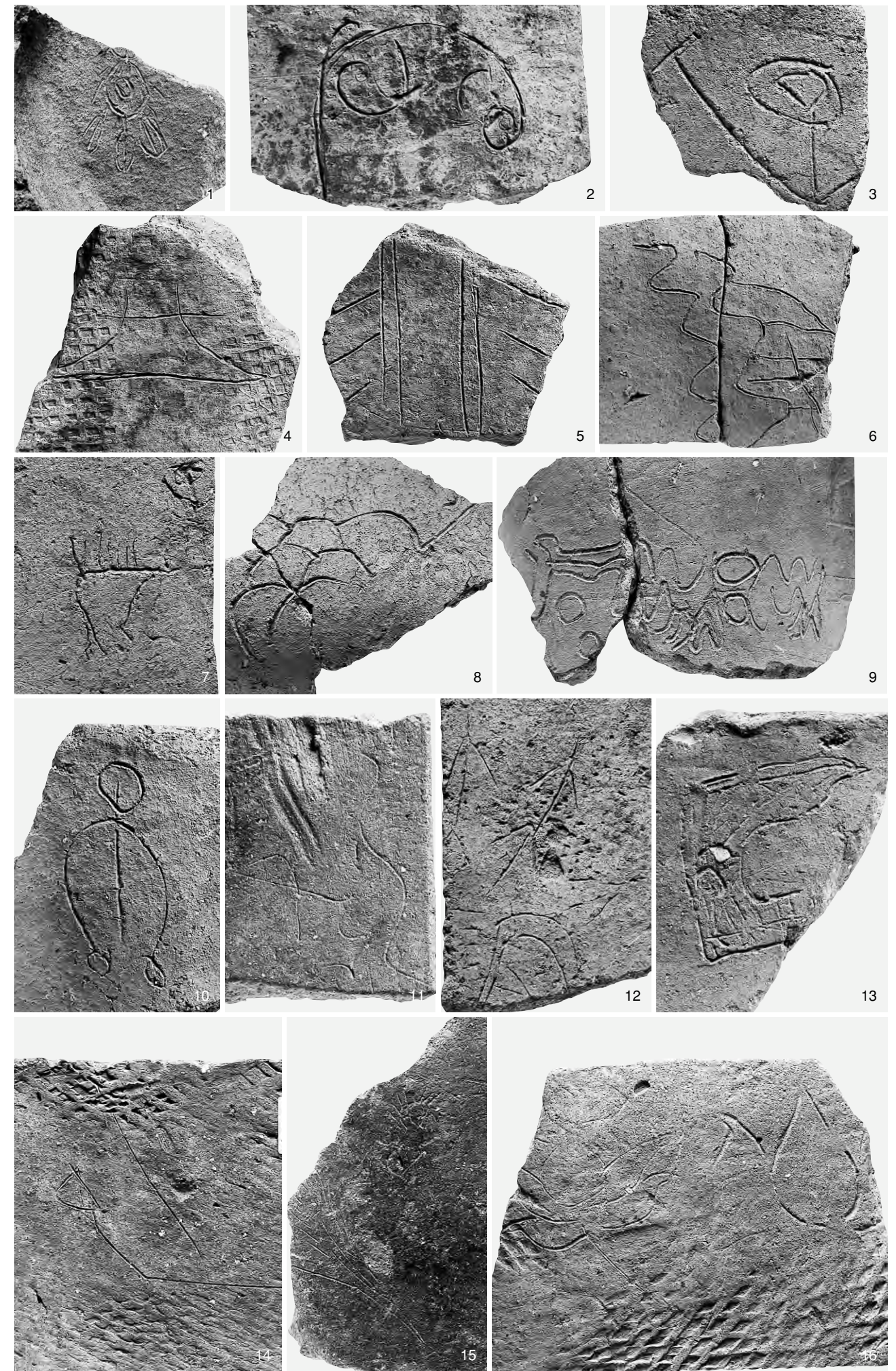
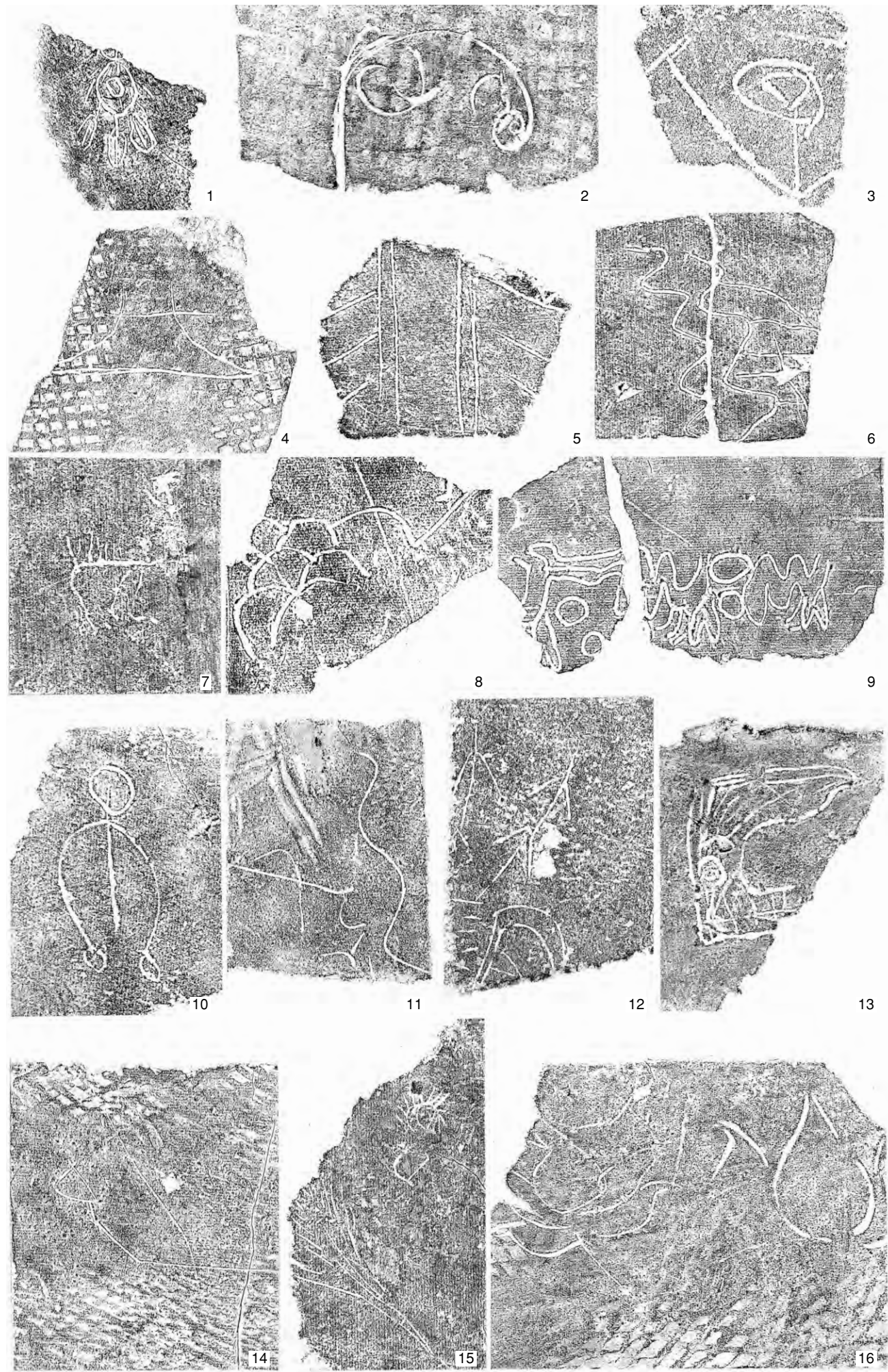

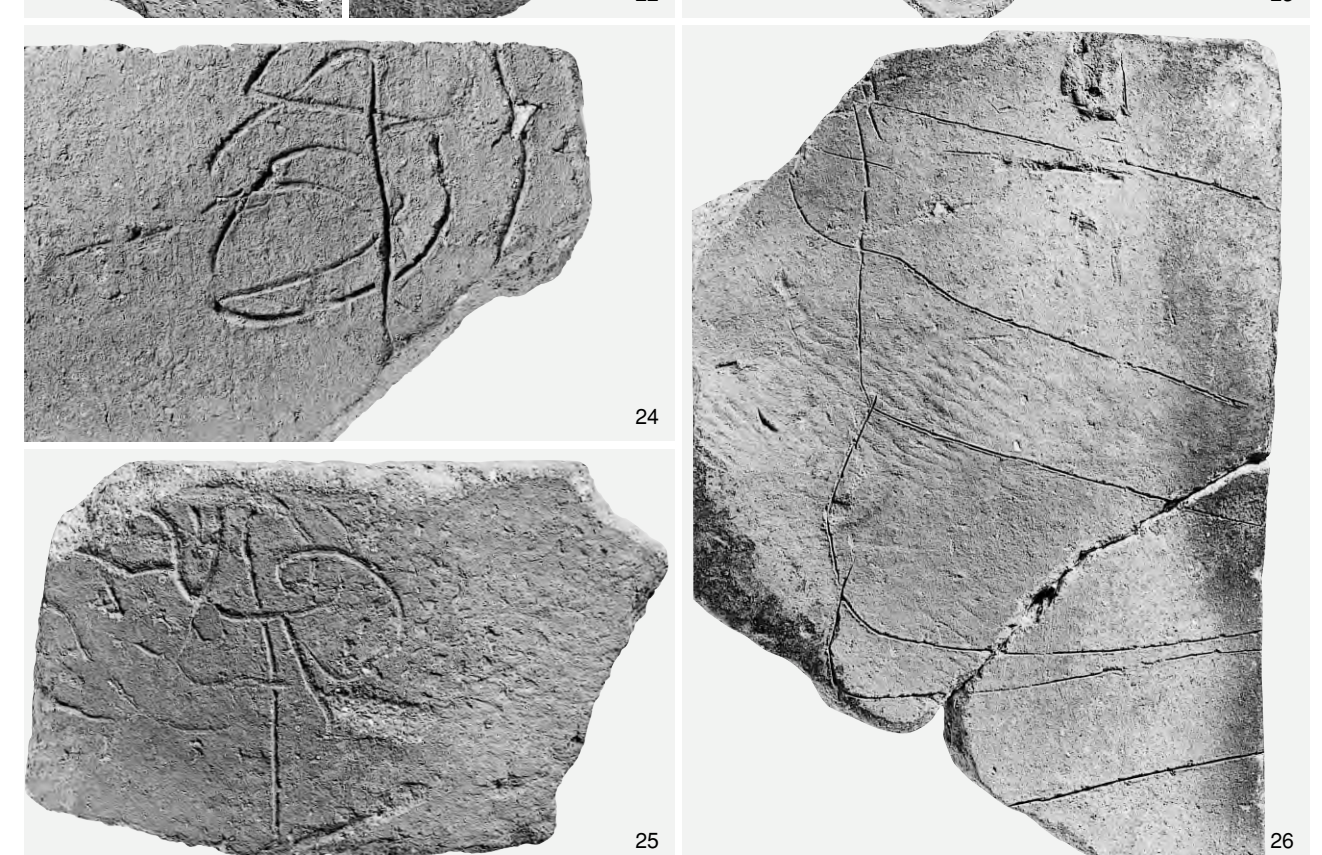
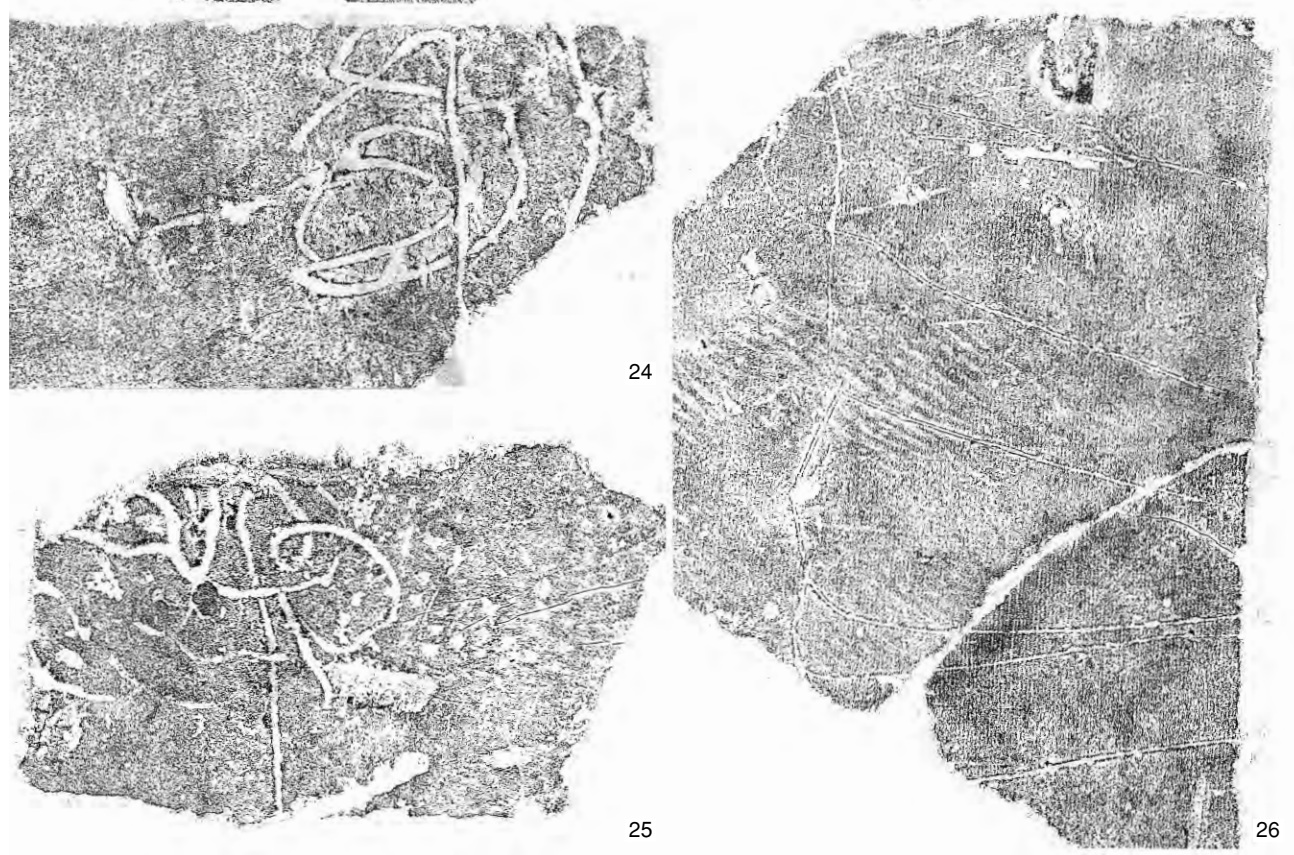
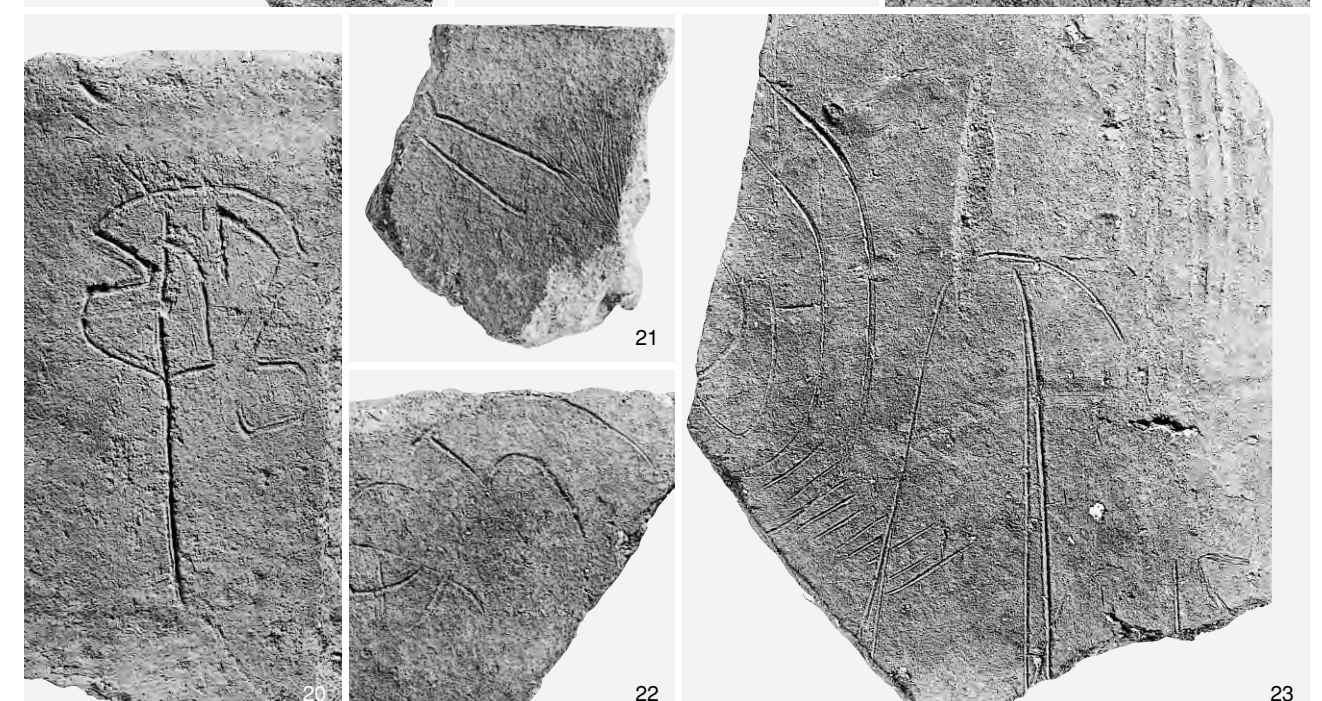
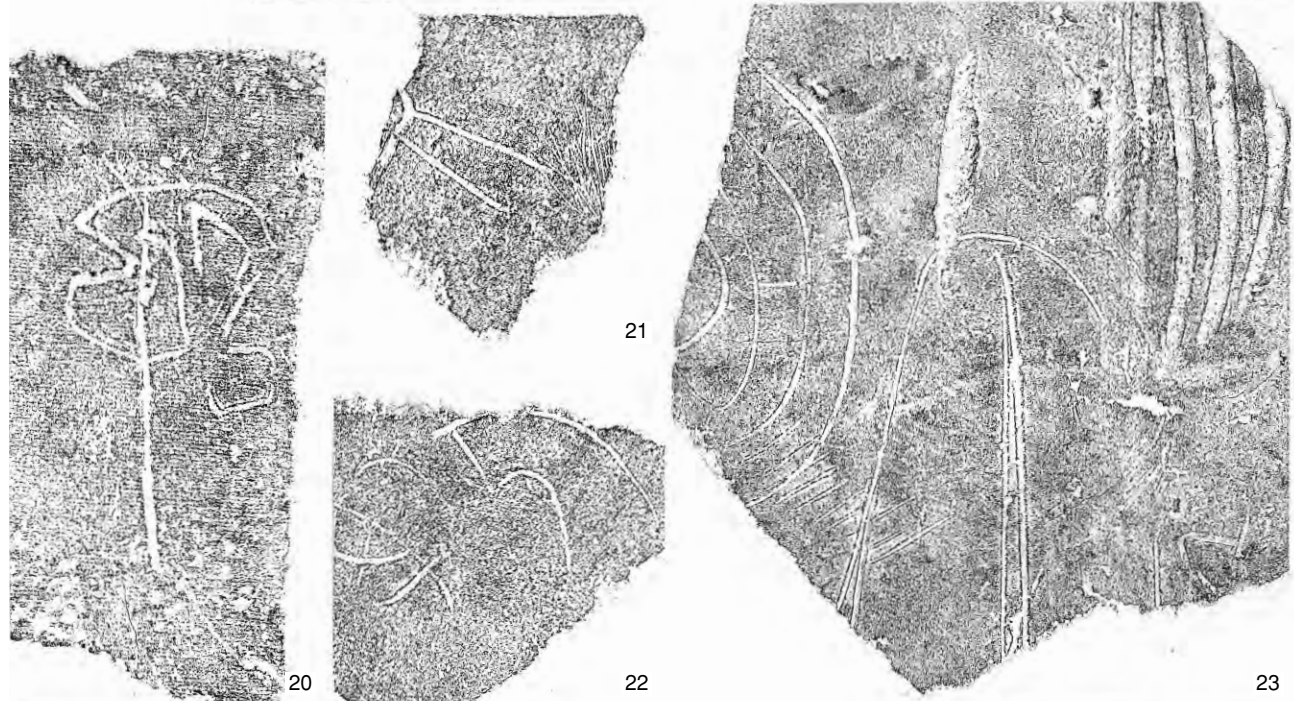
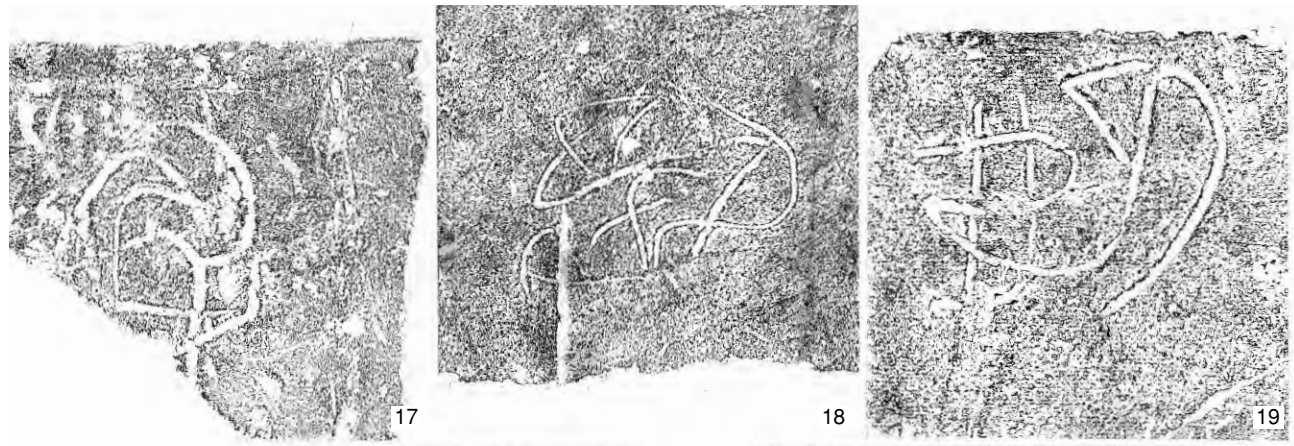

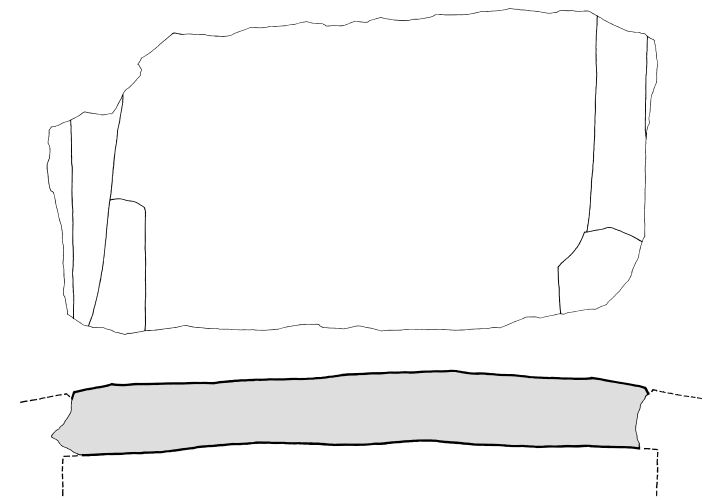

11 隅木蓋瓦

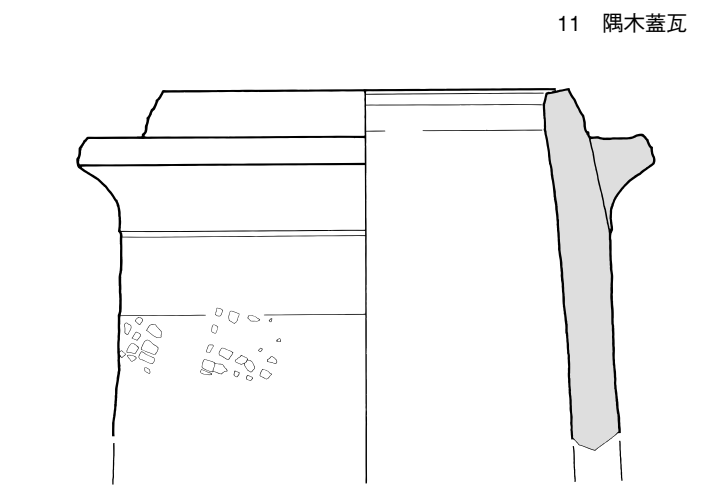

10 鏝付き土管

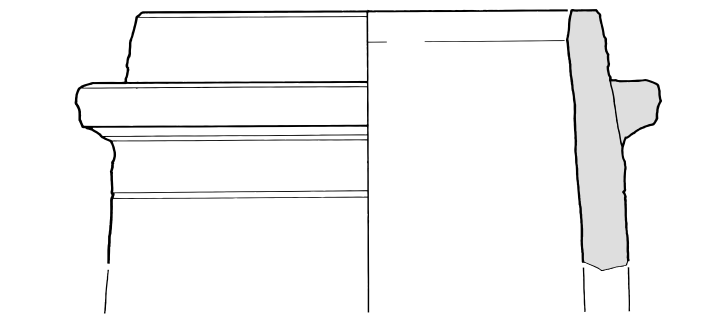

7 鏝付き土管

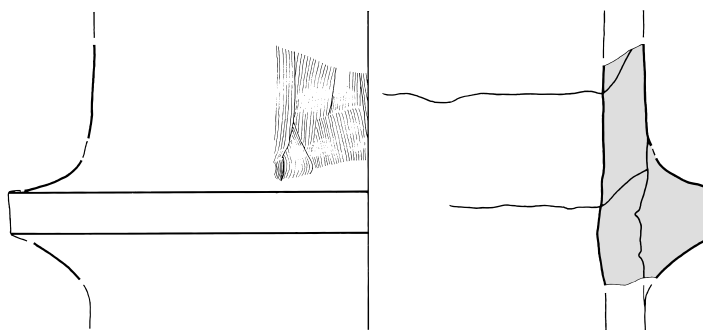

9 土管様製品

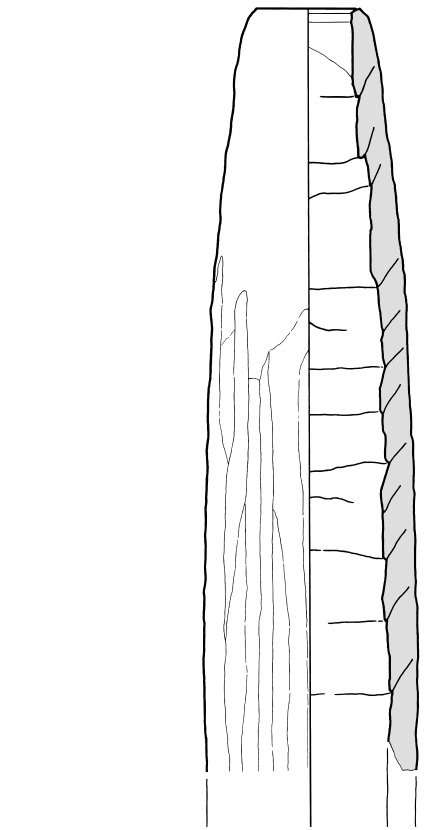

6 行基風土管

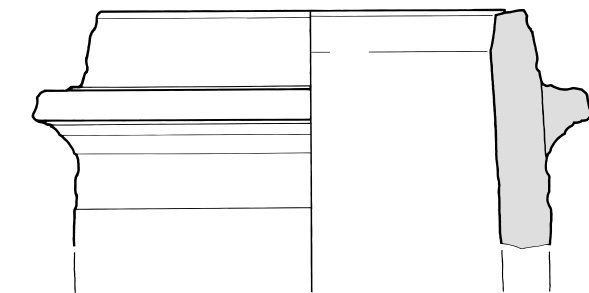

11 鏝付き土管

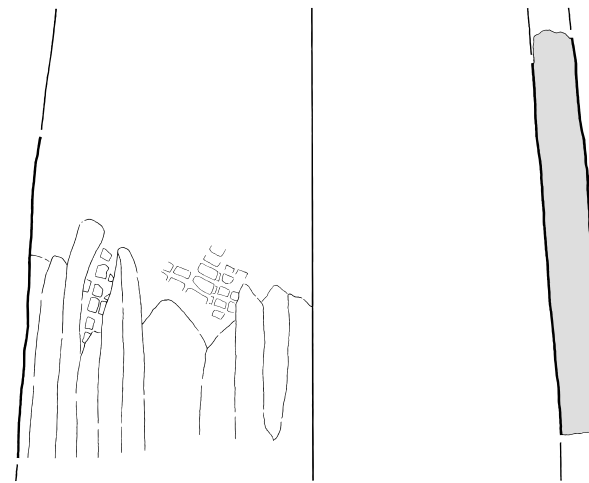

8 鏝付き土管

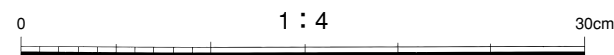

1 方塼A2 (半截)



2 方塼B2



3 方塼C



4 加工塼



5 加工塼



6 行基風土管



7 鏝付き土管



8 鏝付き土管



9 土管様製品

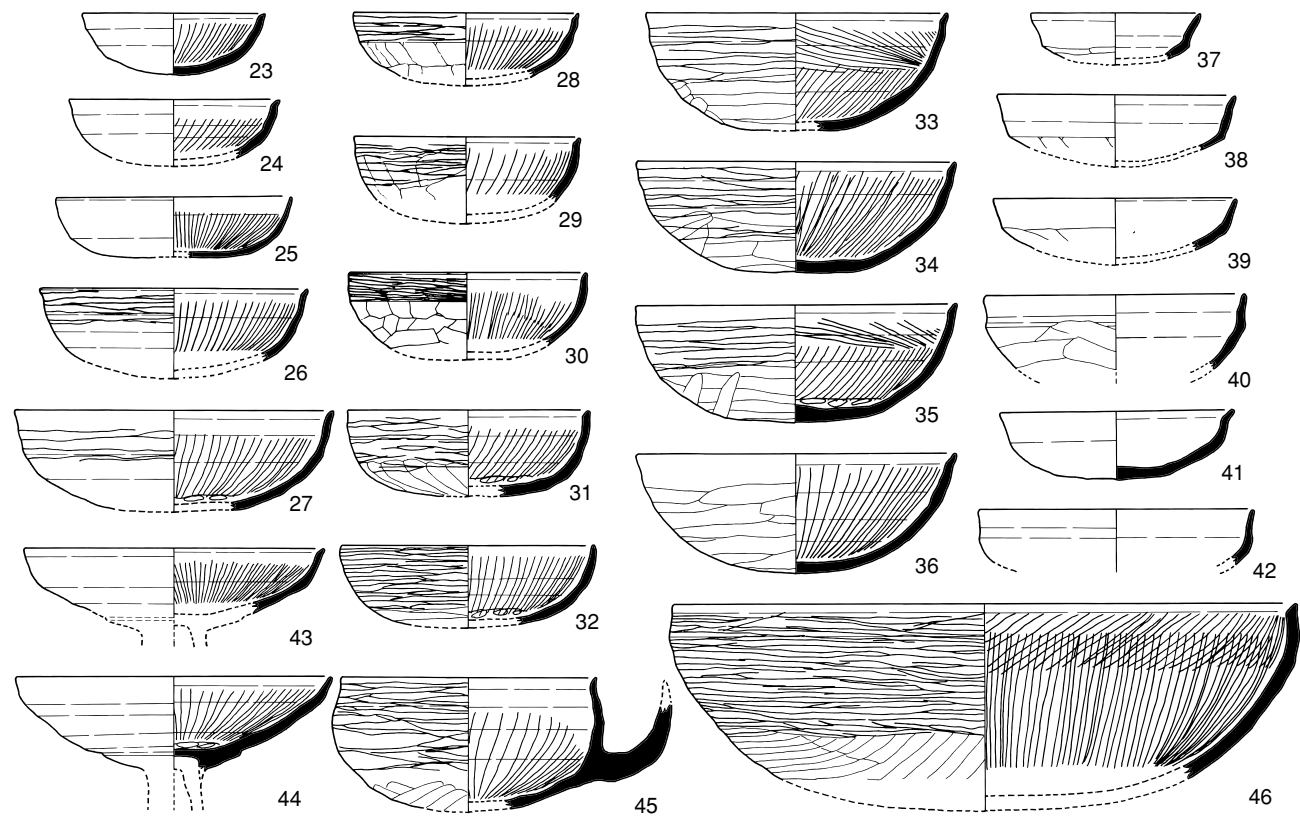
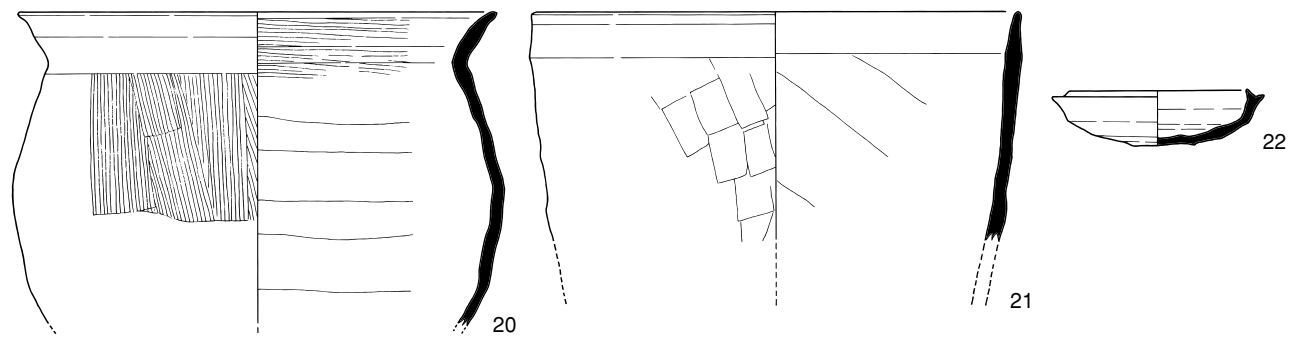
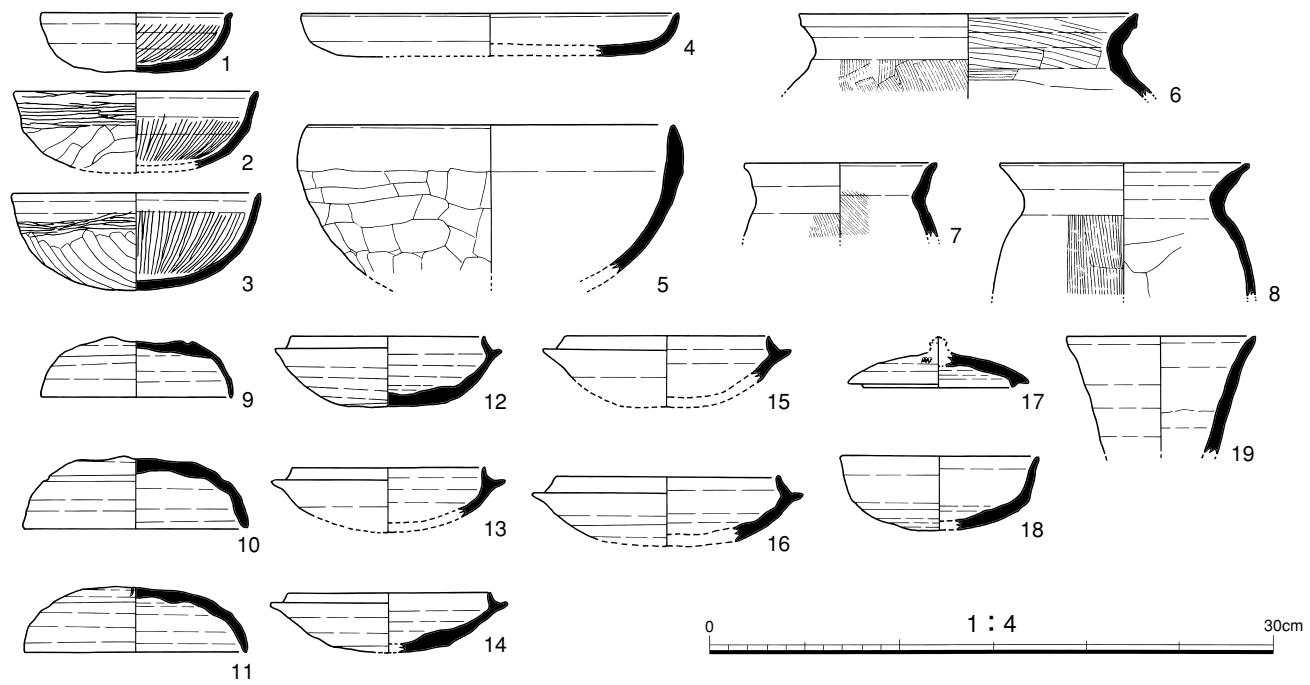

1~19 SD619 20~22 SD619・整地土 23~46 整地土

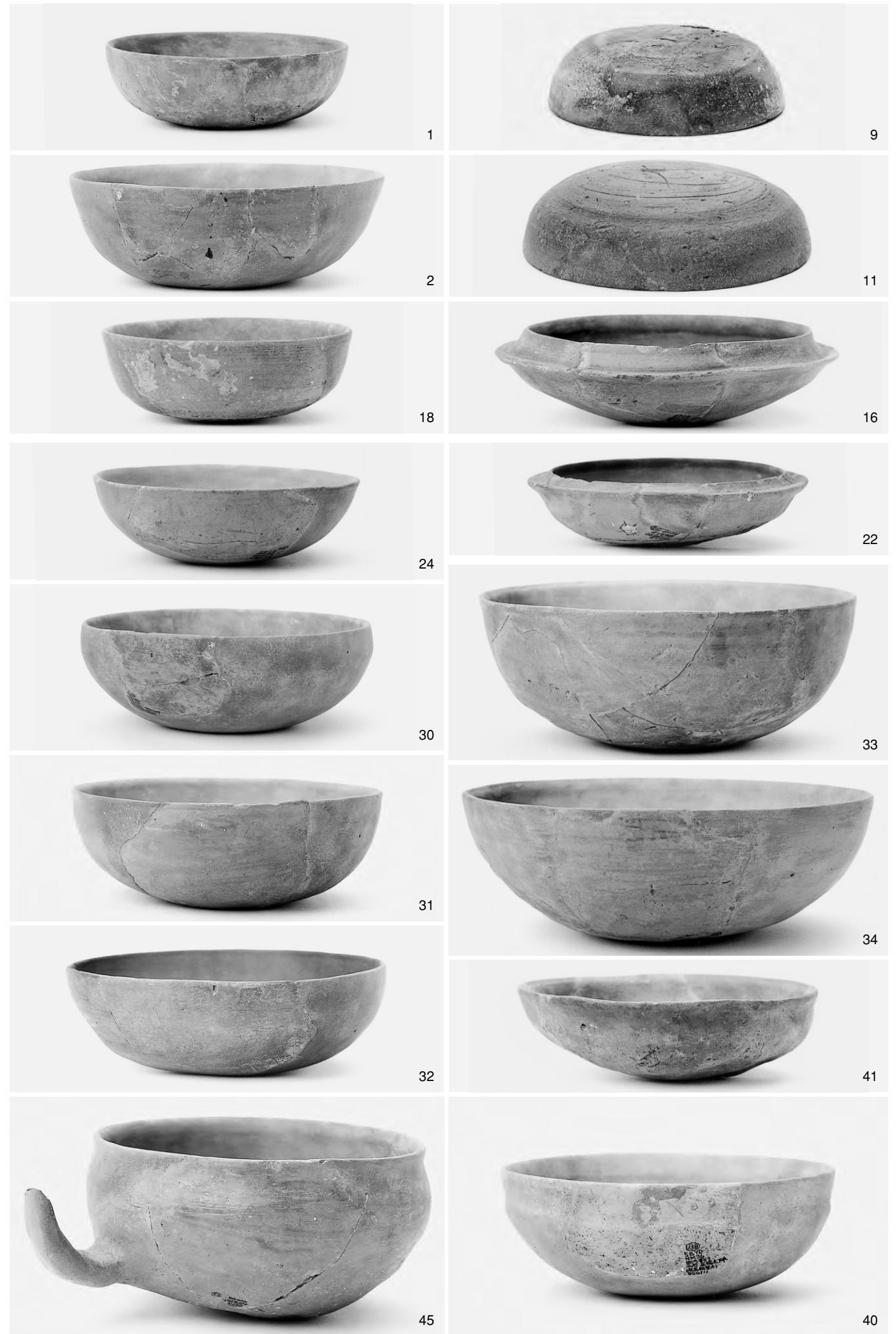

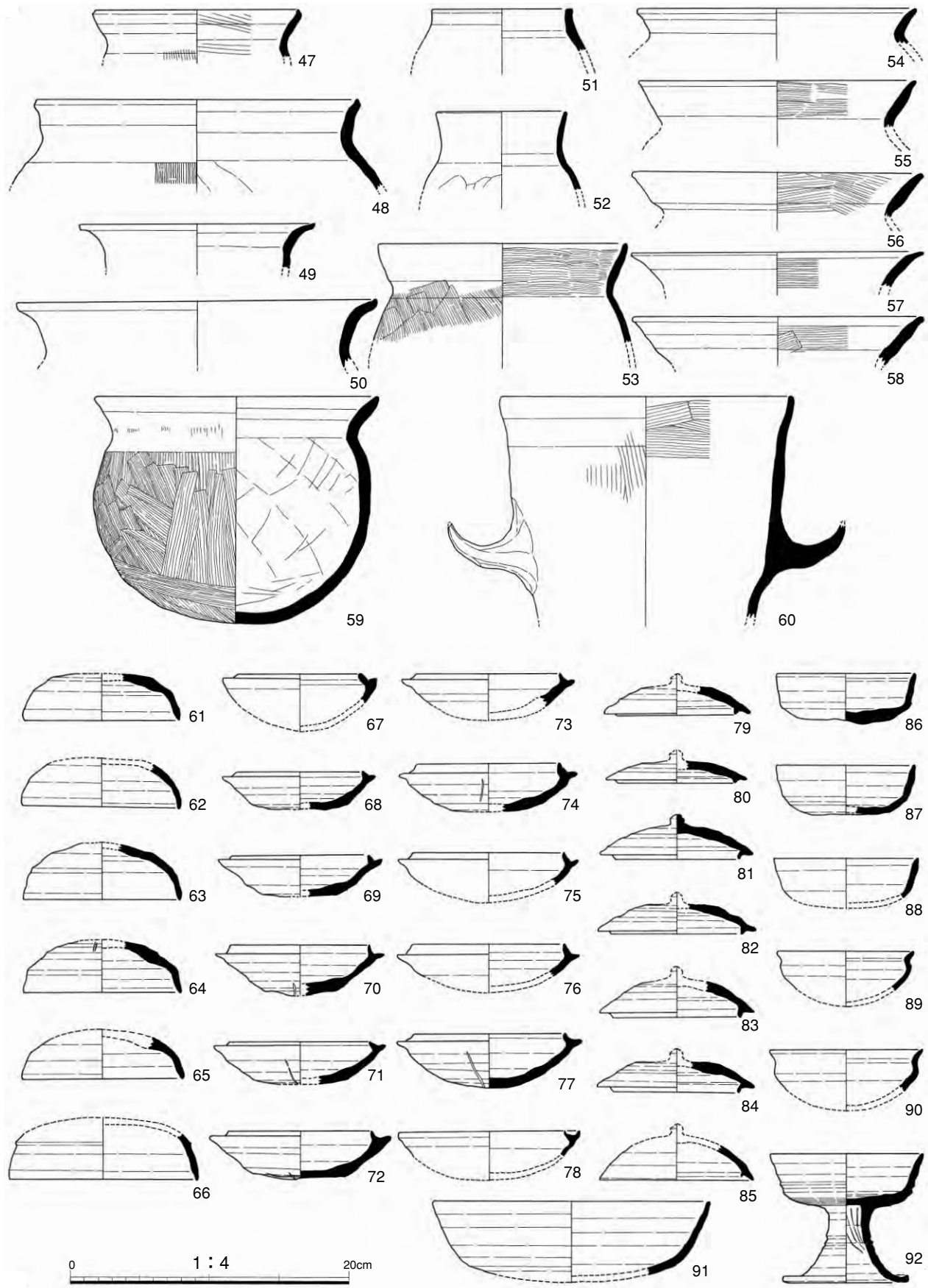

47~92 整地土

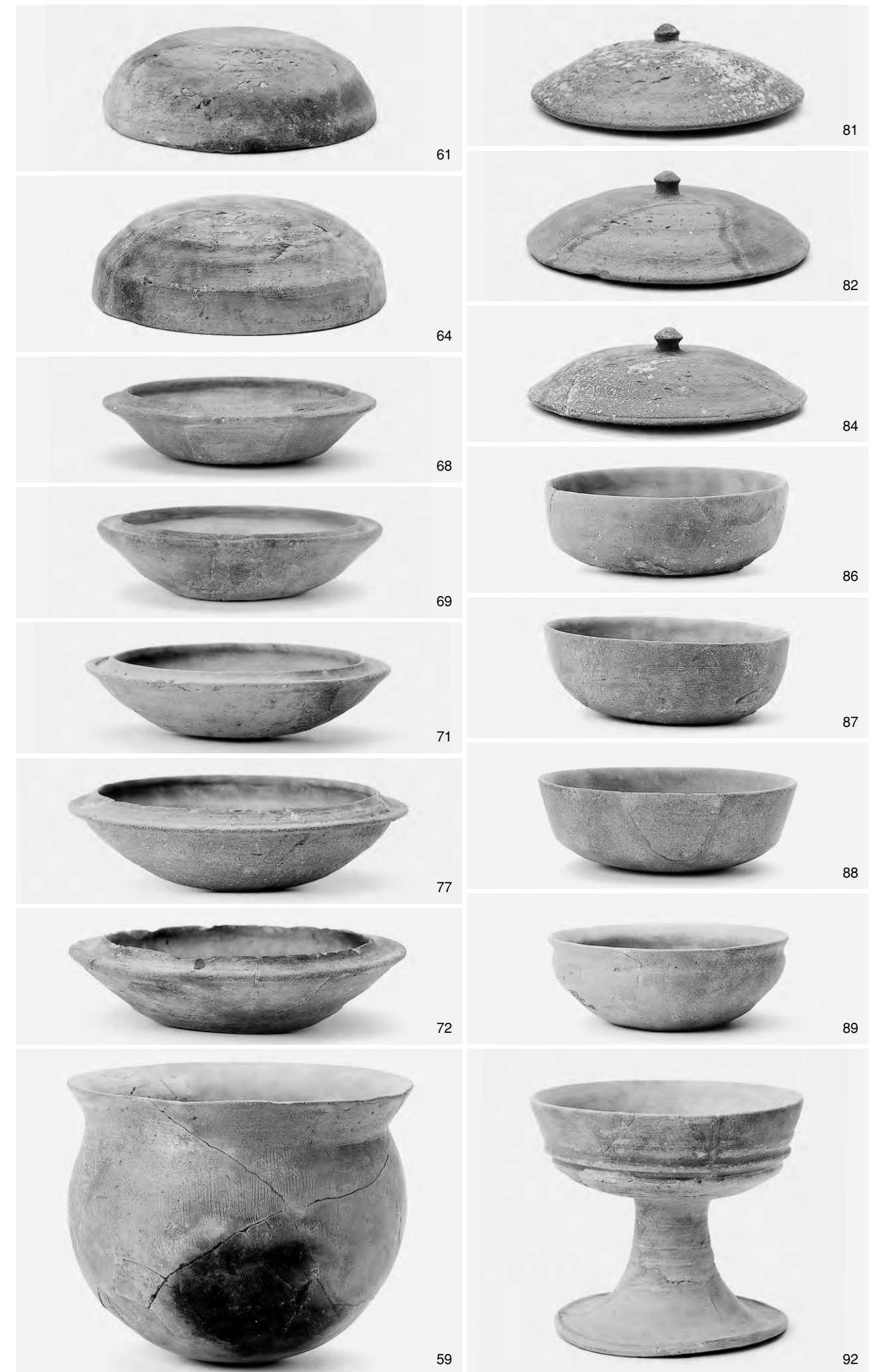

1 : 2(59のみ1 : 3)

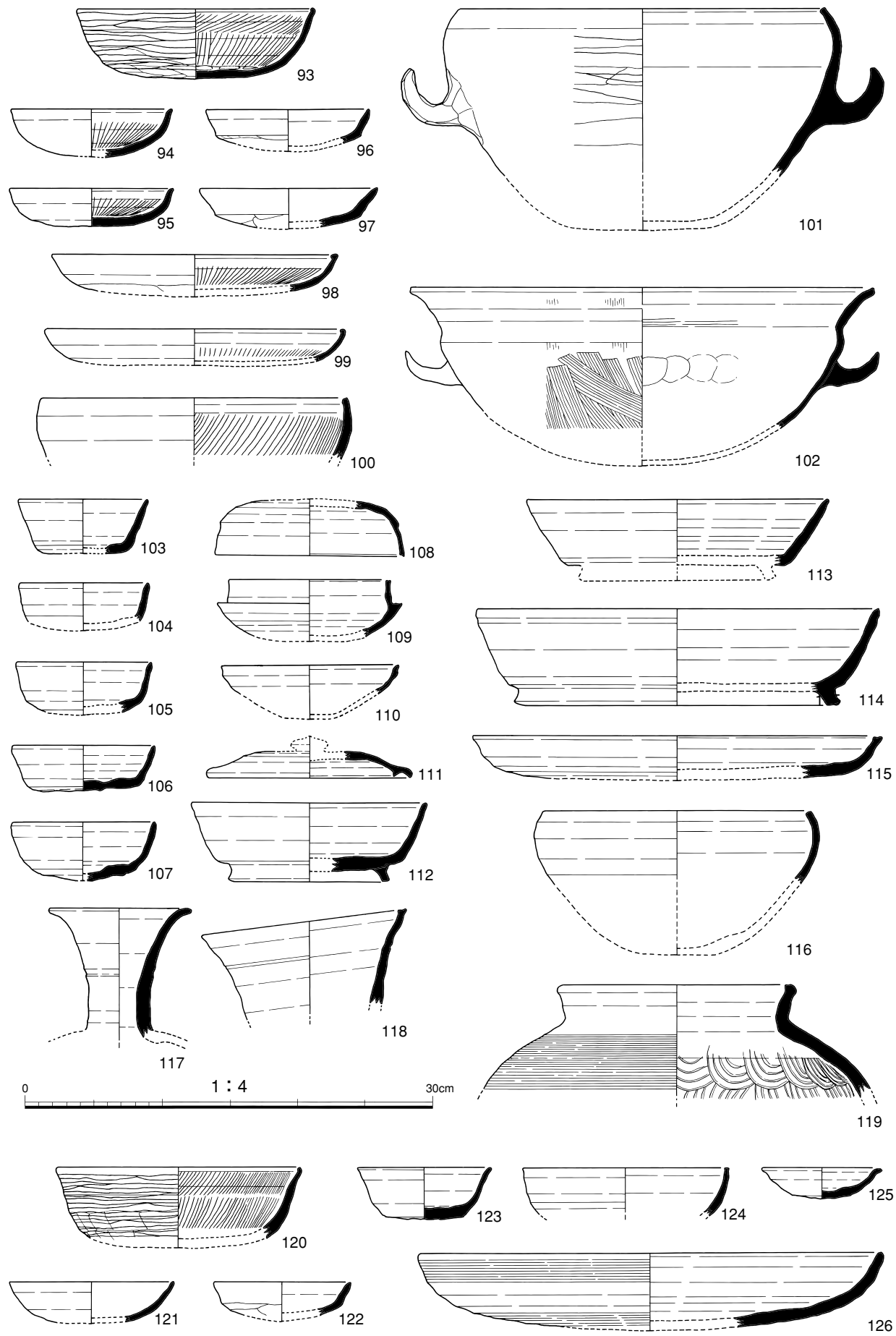

93~119 SK006

120~126 SK405

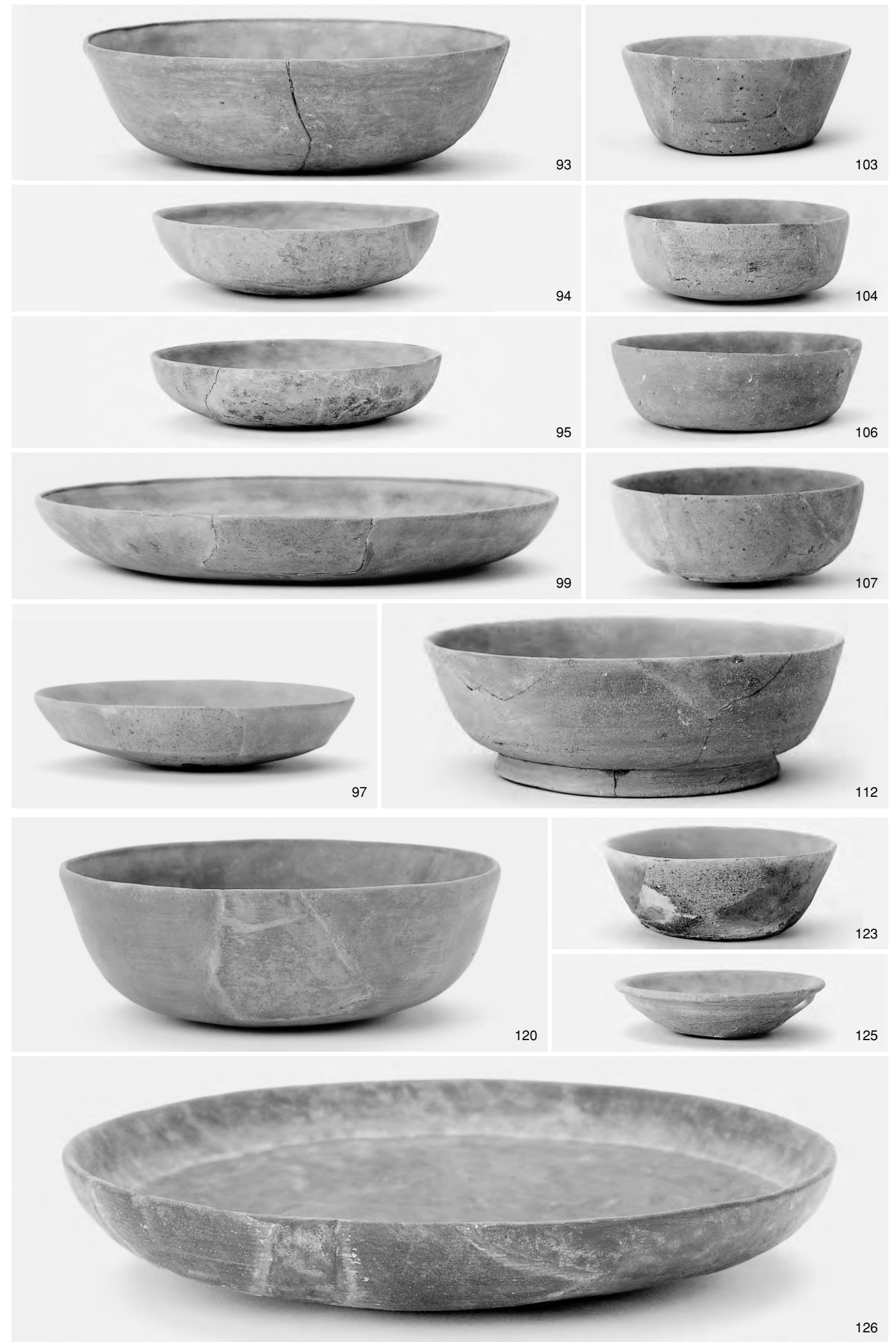

1:2

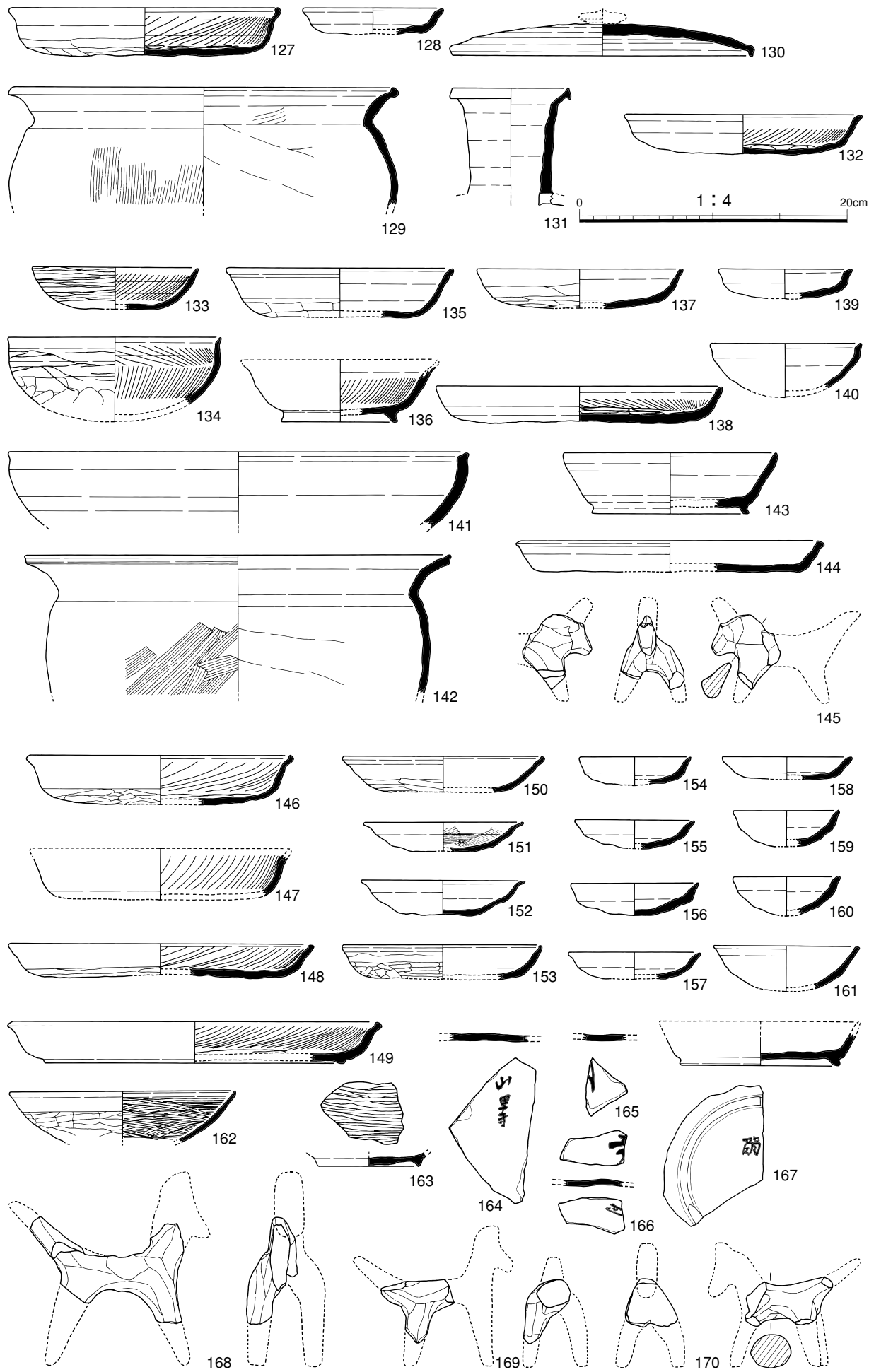

127~131 瓦敷直上 132 SD611 133~145 SD625A 146~170 SD625B



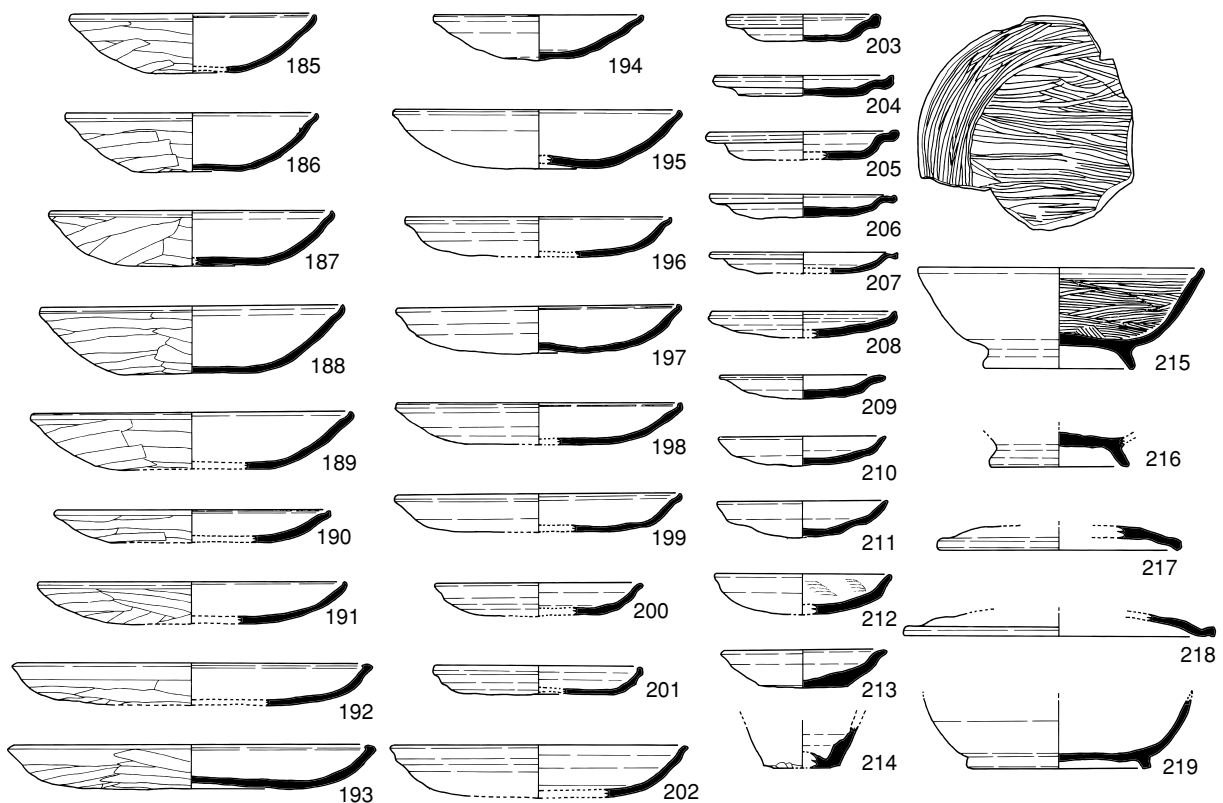
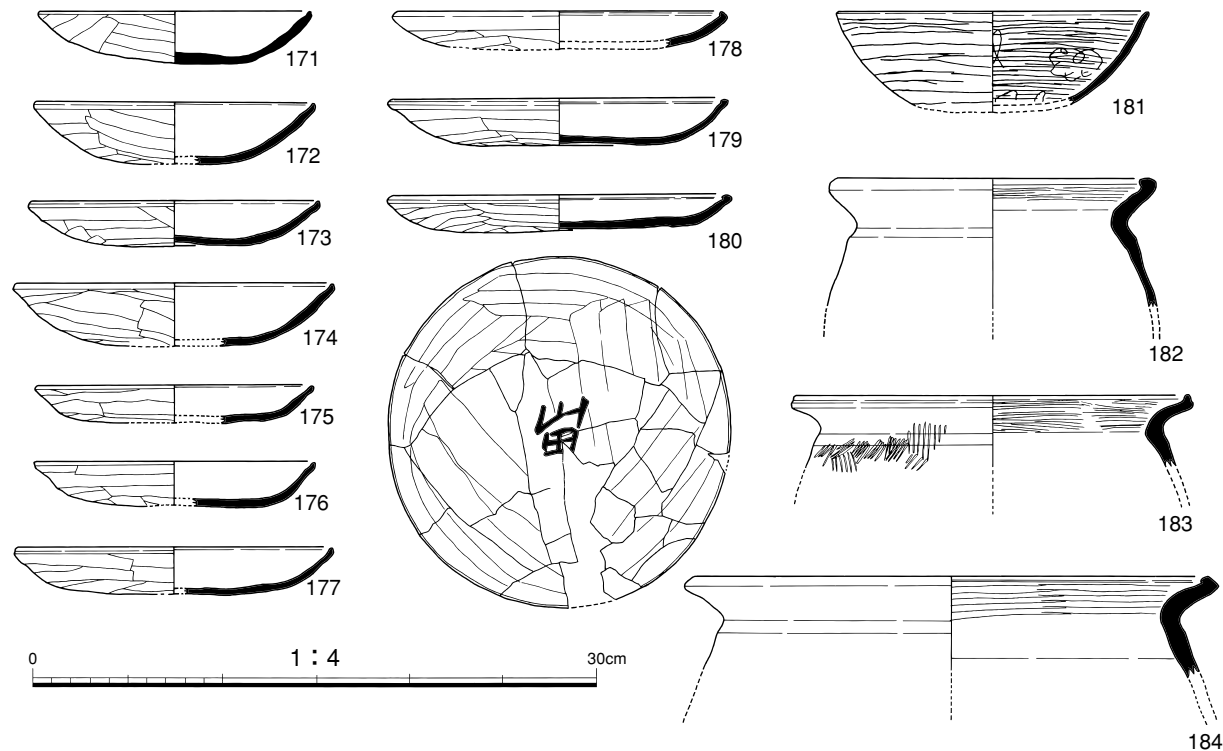

■ 緑釉 ■ 褐釉 □ 白釉 ■ 釉銀化

171~184 SB660B基壇土(暗青灰色砂質土) 185~227 SB660B周辺の黒灰色粘土(220~226は鉛釉陶器)

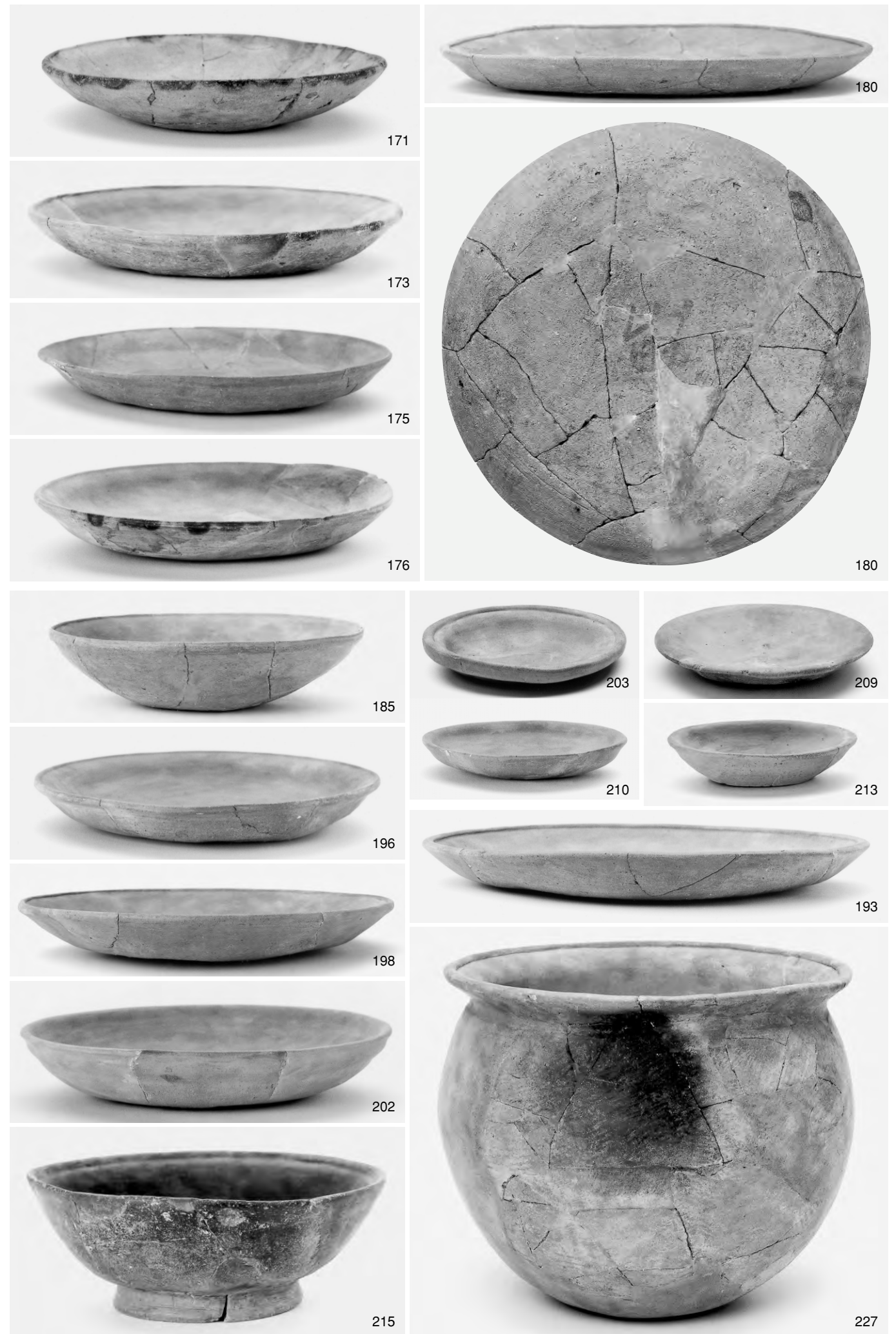

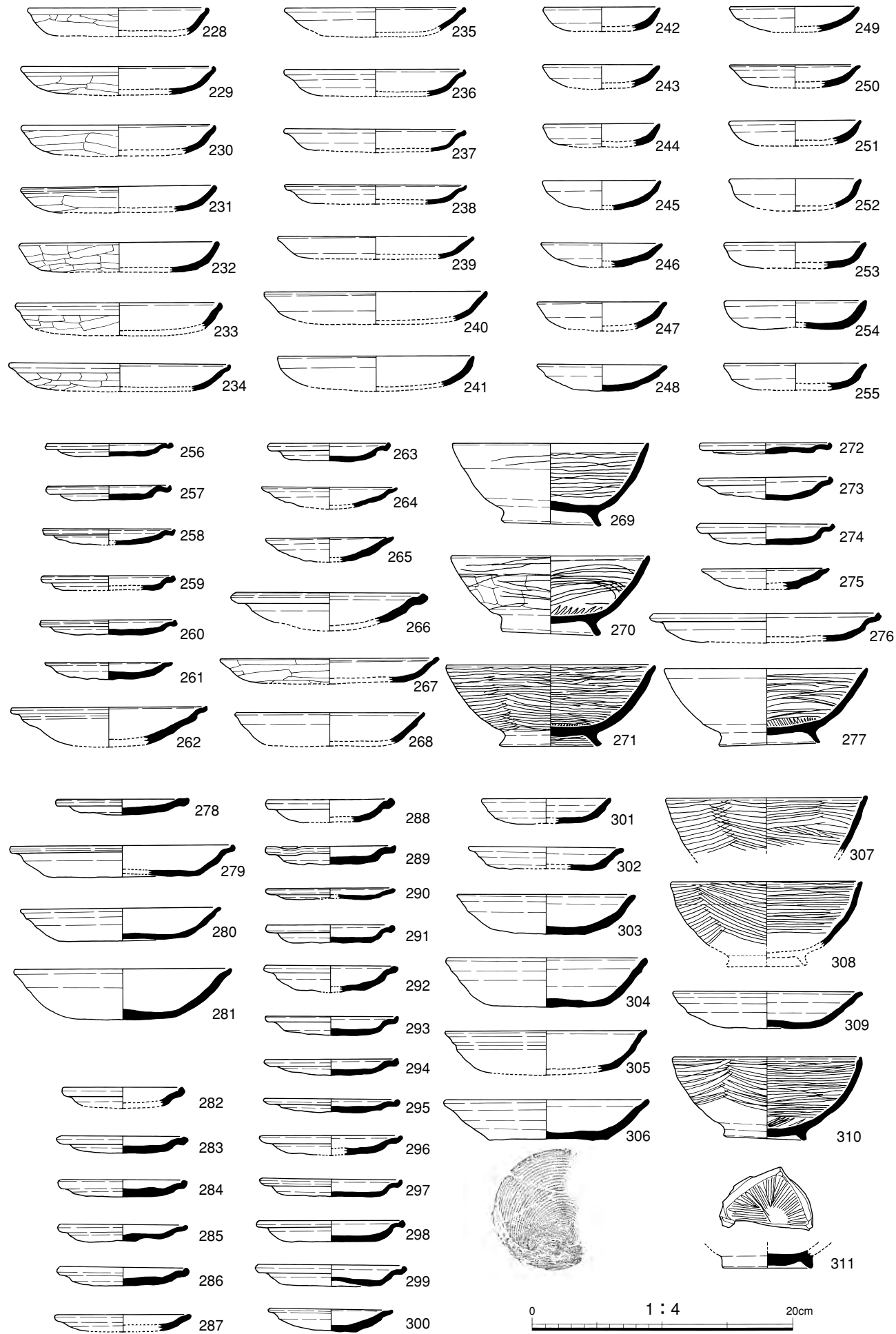

228~255 灯笼周围 256~277 SC060 278~281 SD565 282~287 SK206 288~308 SX429
309・310 SK434



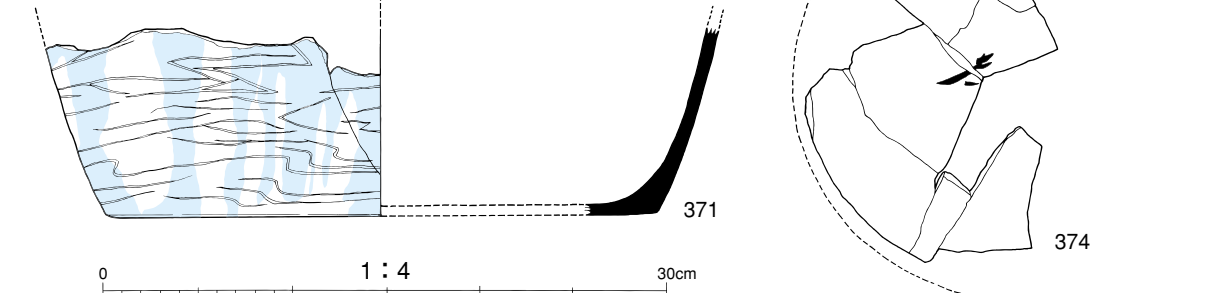
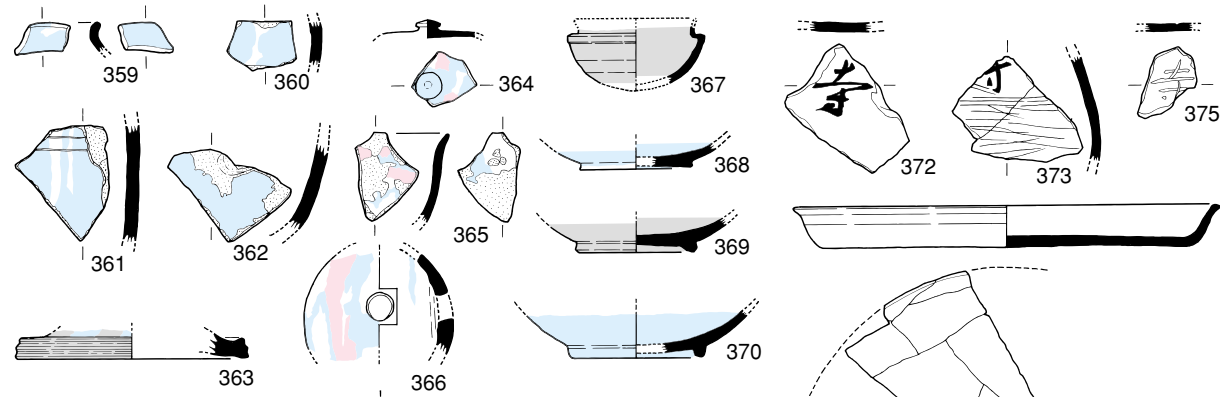
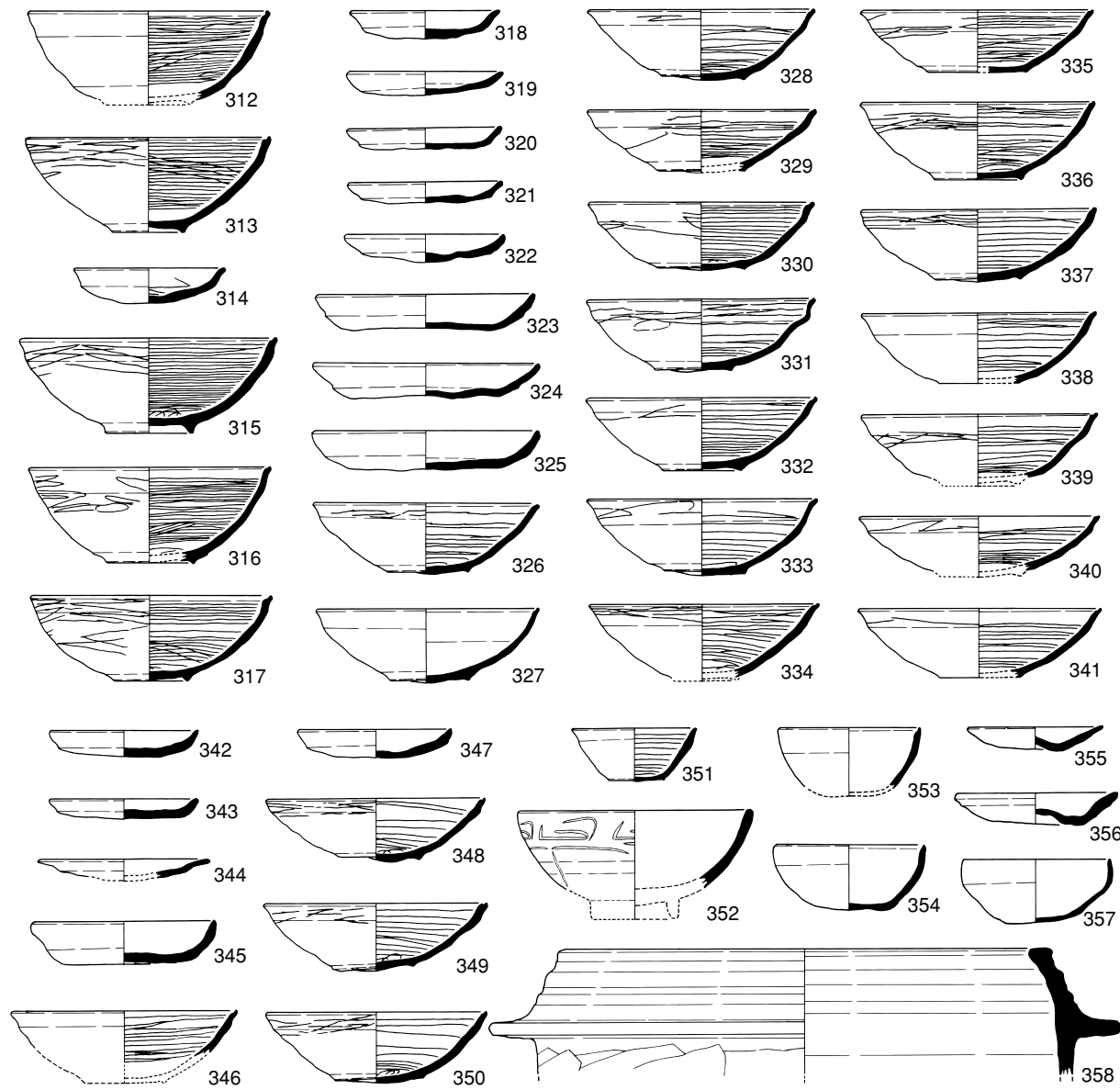

0 1:4 30cm

■ 緑釉 ■ 褐釉 □ 白釉 ■ 釉銀化

312 SD209 313 SD210 314 SD239 315 SD215 316 金堂周辺青灰色粘土 317 金堂周辺灰褐色土
 318~341 SE230 342~346 SK440 347~350 SE218 351・352 SD222 353・354 SE231 355 SD223
 356~358 SE480 359~371 SB660B周辺ほか(鉛釉陶器) 372~375 SB001周辺ほか(墨書・刻書土器)

